



# LMS161-15100

LMS1xx

2D LIDAR SENSORS

**SICK**  
Sensor Intelligence.



### Ordering information

Type	part no.
LMS161-15100	1136200

Other models and accessories → [www.sick.com/LMS1xx](http://www.sick.com/LMS1xx)



### Detailed technical data

#### Features

<b>Application</b>	Outdoor, Indoor
<b>Light source</b>	Infrared (905 nm)
<b>Laser class</b>	1 (IEC 60825-1:2014, EN 60825-1:2014+A11:2021)
<b>Aperture angle</b>	Horizontal 270°
<b>Scanning frequency</b>	25 Hz 50 Hz
<b>Angular resolution</b>	Horizontal 0.25° 0.5°
<b>Heating</b>	Yes
<b>Working range</b>	0.5 m ... 50 m
<b>Scanning range</b>	At 10% remission factor 30 m At 90% remission factor 50 m
<b>Amount of evaluated echoes</b>	2
<b>Fog correction</b>	Yes

#### Mechanics/electronics

<b>Connection type</b>	4 x M12 round connector
<b>Supply voltage</b>	10.8 V DC ... 30 V DC
<b>Power consumption</b>	Typ. 8 W, heating typ. 35 W
<b>Housing color</b>	Gray (RAL 7032)
<b>Enclosure rating</b>	IP67 (EN 60529, Section 14.2.7)
<b>Protection class</b>	III (EN 61010-1:2010-10)
<b>Weight</b>	1.1 kg
<b>Dimensions (L x W x H)</b>	105 mm x 102 mm x 162 mm

<b>MTBF</b>	> 100 years
<b>MTTFd</b>	> 100 years

### Safety-related parameters

<b>MTTF<sub>D</sub></b>	> 100 years
-------------------------	-------------

### Performance

<b>Response time</b>	≥ 20 ms
<b>Detectable object shape</b>	Almost any
<b>Systematic error</b>	± 30 mm <sup>1)</sup>
<b>Statistical error</b>	12 mm <sup>1)</sup>
<b>Integrated application</b>	Field evaluation
<b>Number of field sets</b>	10 fields
<b>Simultaneous evaluation cases</b>	10

<sup>1)</sup> Typical value; actual value depends on environmental conditions.

### Interfaces

<b>Ethernet</b>	Function	✓ , TCP/IP
	Data transmission rate	Data interface (read result output) 10/100 MBit/s
<b>Serial</b>	Function	✓ , RS-232
	Data transmission rate	Data interface (read result output), Service interface 9.6 kBaud ... 115.2 kBaud
<b>CAN</b>	Function	✓
		Extension of outputs
<b>Digital inputs/outputs</b>	Inputs	4 digital (thereof 2 suitable for encoders)
	Outputs	3
<b>Optical indicators</b>		7-segment display (plus 5 LEDs showing device status, contamination warning and initial condition)

### Ambient data

<b>Remission factor</b>	3 % ... > 1,000 % (reflectors)
<b>Electromagnetic compatibility (EMC)</b>	EN 61000-6-2:2005 / EN 61000-6-3:2007+A1:2011
<b>Vibration resistance</b>	EN 60068-2-6 (1995-04)
<b>Shock resistance</b>	EN 60068-2-27 (1993-03)
<b>Ambient operating temperature</b>	-40 °C ... +60 °C
<b>Storage temperature</b>	-40 °C ... +70 °C
<b>Ambient light immunity</b>	80,000 lx

### General notes

<b>Note on use</b>	The sensor does not constitute a safety component as defined by relevant legislation on machine safety.
--------------------	---

### Certificates

<b>EU declaration of conformity</b>	✓
-------------------------------------	---

<b>UK declaration of conformity</b>	✓
<b>ACMA declaration of conformity</b>	✓
<b>China RoHS</b>	✓
<b>Information according to Art. 3 of Data Act (Regulation EU 2023/2854)</b>	✓

### Classifications

<b>ECLASS 5.0</b>	27270990
<b>ECLASS 5.1.4</b>	27270990
<b>ECLASS 6.0</b>	27270913
<b>ECLASS 6.2</b>	27270913
<b>ECLASS 7.0</b>	27270913
<b>ECLASS 8.0</b>	27270913
<b>ECLASS 8.1</b>	27270913
<b>ECLASS 9.0</b>	27270913
<b>ECLASS 10.0</b>	27270913
<b>ECLASS 11.0</b>	27270913
<b>ECLASS 12.0</b>	27270913
<b>ETIM 5.0</b>	EC002550
<b>ETIM 6.0</b>	EC002550
<b>ETIM 7.0</b>	EC002550
<b>ETIM 8.0</b>	EC002550
<b>UNSPSC 16.0901</b>	41111615

### Dimensional drawing

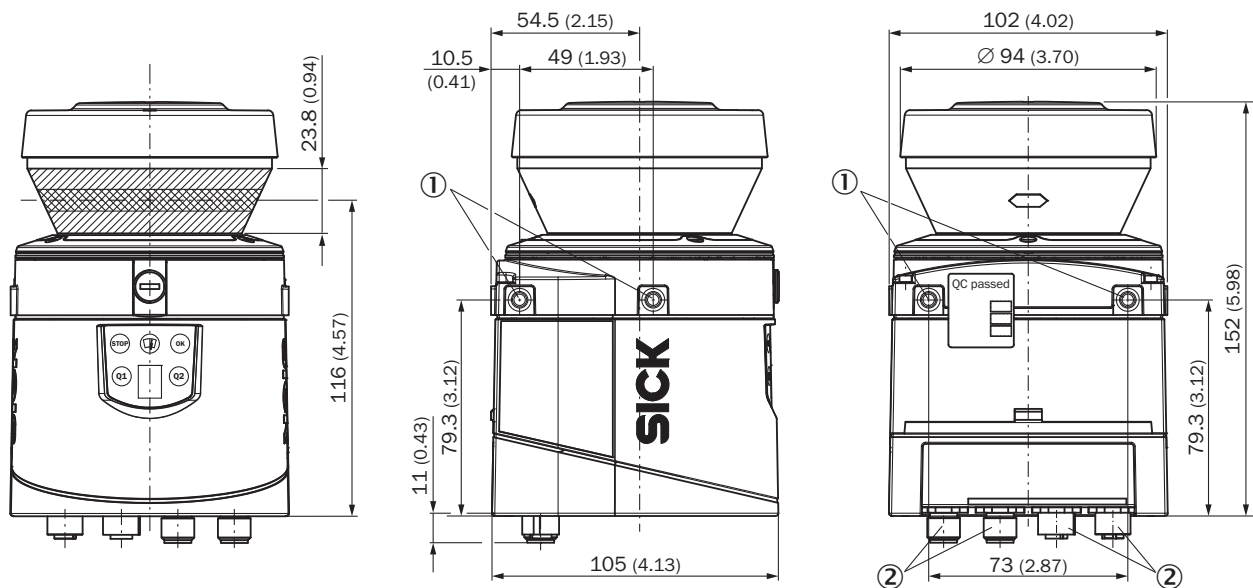

Dimensions in mm (inch)  
 ① Mounting hole M5 x 7.5

② Connector M12

Working range diagram

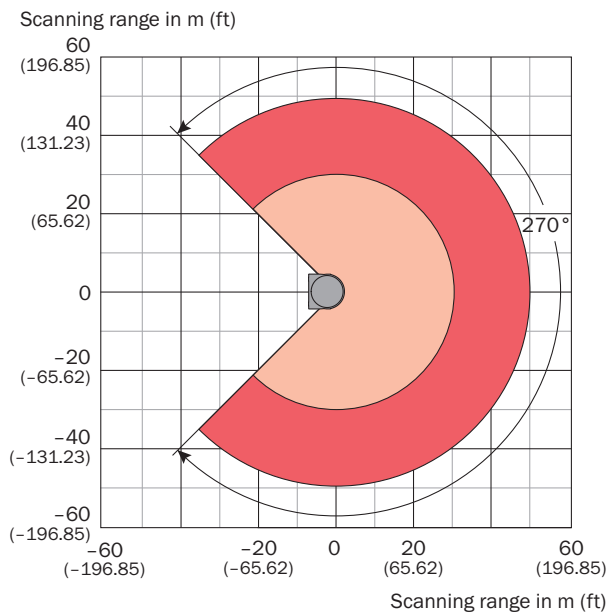

- Scanning range max. 50 m (164.04 ft)
- Scanning range for objects up to 10 % remission 30 m (98.43 ft)

Connection type Ethernet

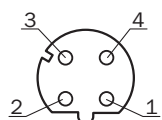

M12 female connector, 4-pin, D-coded

- ① TX+
- ② RX+
- ③ TX-
- ④ RX-

PIN assignment “data” connection

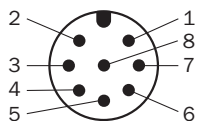

M12 male connector, 8-pin, A-coded

- ① RxD (HOST)
- ② TxD (HOST)
- ③ CAN\_HI
- ④ CAN\_LO

- ⑤ GND RS/CAN
- ⑥ In<sub>1</sub>
- ⑦ In<sub>2</sub>
- ⑧ GND IN1/2

### PIN assignment I/O connection

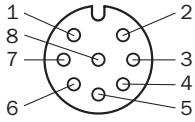

female connector M12, 8-pin, A-coded

- ① LMS11x: INC1 A / LMS15x/LMS16x: INC1 A or IN4 (switchable, pins 1 and 2 must be switched together)
- ② LMS11x: INC1 B / LMS15x/LMS16x: INC1 B or IN3 (switchable, pins 1 and 2 must be switched together)
- ③ GND INC1
- ④ OUT1 A
- ⑤ OUT2 A
- ⑥ OUT3 A
- ⑦ OUT1 ... 3 B
- ⑧ OUT1 ... 3 R

### PIN assignment Power

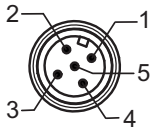

Connector M12, 5-pin, A-coded

- ① V<sub>s</sub>
- ② V<sub>s</sub> heat.
- ③ GND
- ④ Reserved
- ⑤ GND heat.

### PIN assignment Service interface









female connector M8, 4-pin

- ① Reserved
- ② RxD AUX
- ③ GND RS
- ④ TxD AUX

## Recommended accessories

Other models and accessories → [www.sick.com/LMS1xx](http://www.sick.com/LMS1xx)

	Brief description	Type	part no.
Mounting systems			
	<ul style="list-style-type: none"> <li><b>Description:</b> Mounting bracket for rear mounting on wall or machine</li> <li><b>Material:</b> Anodized aluminum</li> <li><b>Details:</b> AlMg3, black anodized</li> <li><b>Packing unit:</b> 1 piece</li> <li><b>Items supplied:</b> Mounting bracket, 4 x M5 x 10 countersunk screws</li> </ul>	Mounting kit 1a	2034324
	<ul style="list-style-type: none"> <li><b>Description:</b> Mounting bracket for rear mounting on wall or machine with protection of optics hood</li> <li><b>Material:</b> Anodized aluminum</li> <li><b>Details:</b> AlMg3, black anodized</li> <li><b>Packing unit:</b> 1 piece</li> <li><b>Items supplied:</b> Mounting bracket, 4 x M5 x 10 countersunk screws</li> </ul>	Mounting kit 1b	2034325
	<ul style="list-style-type: none"> <li><b>Description:</b> Mounting bracket, adjustable lateral axis, only in conjunction with mounting kit 1a (2034324) or 1b (2034325)</li> <li><b>Material:</b> Anodized aluminum</li> <li><b>Details:</b> AlMg3, black anodized</li> <li><b>Packing unit:</b> 1 piece</li> <li><b>Items supplied:</b> Mounting bracket, 4 x countersunk screws with washers M4 x 10, 4 x spring washer</li> </ul>	Mounting kit 2	2039302
	<ul style="list-style-type: none"> <li><b>Description:</b> Mounting plate, adjustable longitudinal axis, only in conjunction with mounting kit 2 (2039302)</li> <li><b>Material:</b> Anodized aluminum</li> <li><b>Details:</b> AlMg3, black anodized</li> <li><b>Packing unit:</b> 1 piece</li> <li><b>Items supplied:</b> Mounting plate, 2 x countersunk screws with washers M4 x 10, 2 x spring washer</li> </ul>	Mounting kit 3	2039303
	<ul style="list-style-type: none"> <li><b>Description:</b> Standard mounting set for weather hood</li> <li><b>Material:</b> Stainless steel 1.4301 (V2A)</li> <li><b>Details:</b> Stainless steel 1.4301 (V2A)</li> <li><b>Items supplied:</b> Mounting bracket, incl. 7 x screws with M6 x 12 washers</li> <li><b>Suitable for:</b> 2085937, 2085938, 2085939, 2046459, 2046458, 2082563, 2082560</li> </ul>	Mounting bracket	2046025
	<ul style="list-style-type: none"> <li><b>Description:</b> Quick-action lock system for weather hood</li> <li><b>Material:</b> Steel, Aluminum</li> <li><b>Details:</b> Clamping piece: steel (X5CRNI1810), Clamping profile: aluminum (ALMGSI0)</li> <li><b>Suitable for:</b> 2085937, 2085938, 2085939, 2046459, 2046458, 2082563, 2082560</li> </ul>	Quick release	2046989

	Brief description	Type	part no.
connectors and cables			
	<ul style="list-style-type: none"> <li>• <b>Connection type head A:</b> Male connector, M12, 4-pin, straight, D-coded</li> <li>• <b>Connection type head B:</b> Male connector, RJ45, 4-pin, straight</li> <li>• <b>Signal type:</b> Ethernet, PROFINET</li> <li>• <b>Cable:</b> 5 m, 4-wire, PUR, halogen-free</li> <li>• <b>Description:</b> Ethernet, shielded, PROFINET</li> <li>• <b>Application:</b> Drag chain operation, Zones with oils and lubricants</li> </ul>	YM2D24-050P-N1MRJA4	2106184
	<ul style="list-style-type: none"> <li>• <b>Description:</b> Sensor/actuator cable, shielded</li> <li>• <b>Connection type head A:</b> Female connector, M12, 8-pin, straight, A-coded</li> <li>• <b>Connection type head B:</b> Flying leads</li> <li>• <b>Signal type:</b> Sensor/actuator cable</li> <li>• <b>Cable:</b> 5 m, 8-wire, PUR, halogen-free</li> <li>• <b>Application:</b> Drag chain operation, Zones with oils and lubricants, Robot, Drag chain operation</li> </ul>	YF2A28-050UA6XLEAX	2095835
	<ul style="list-style-type: none"> <li>• <b>Connection type head A:</b> Female connector, M12, 5-pin, straight, A-coded</li> <li>• <b>Connection type head B:</b> Flying leads</li> <li>• <b>Signal type:</b> Power</li> <li>• <b>Cable:</b> 5 m, 4-wire, PUR, halogen-free</li> <li>• <b>Description:</b> Power, shielded</li> <li>• <b>Connection systems:</b> Flying leads</li> </ul>	YF2A64-050XXXXLEAX	6036159
	<ul style="list-style-type: none"> <li>• <b>Description:</b> Sensor/actuator cable, shielded</li> <li>• <b>Connection type head A:</b> Female connector, M12, 8-pin, straight, A-coded</li> <li>• <b>Connection type head B:</b> Flying leads</li> <li>• <b>Signal type:</b> Sensor/actuator cable</li> <li>• <b>Cable:</b> 0.6 m, 8-wire, PUR, halogen-free</li> <li>• <b>Application:</b> Drag chain operation, Zones with oils and lubricants, Robot, Drag chain operation</li> </ul>	YF2A28-C60UA6XLEAX	2145470
	<ul style="list-style-type: none"> <li>• <b>Description:</b> Sensor/actuator cable, shielded</li> <li>• <b>Connection type head A:</b> Female connector, M12, 8-pin, straight, A-coded</li> <li>• <b>Connection type head B:</b> Flying leads</li> <li>• <b>Signal type:</b> Sensor/actuator cable</li> <li>• <b>Cable:</b> 1 m, 8-wire, PUR, halogen-free</li> <li>• <b>Application:</b> Drag chain operation, Zones with oils and lubricants, Robot, Drag chain operation</li> </ul>	YF2A28-010UA6XLEAX	2145471
	<ul style="list-style-type: none"> <li>• <b>Description:</b> Sensor/actuator cable, shielded</li> <li>• <b>Connection type head A:</b> Female connector, M12, 8-pin, straight, A-coded</li> <li>• <b>Connection type head B:</b> Flying leads</li> <li>• <b>Signal type:</b> Sensor/actuator cable</li> <li>• <b>Cable:</b> 2 m, 8-wire, PUR, halogen-free</li> <li>• <b>Application:</b> Drag chain operation, Zones with oils and lubricants, Robot, Drag chain operation</li> </ul>	YF2A28-020UA6XLEAX	2145472
	<ul style="list-style-type: none"> <li>• <b>Description:</b> Sensor/actuator cable, shielded</li> <li>• <b>Connection type head A:</b> Female connector, M12, 8-pin, straight, A-coded</li> <li>• <b>Connection type head B:</b> Flying leads</li> <li>• <b>Signal type:</b> Sensor/actuator cable</li> <li>• <b>Cable:</b> 3 m, 8-wire, PUR, halogen-free</li> <li>• <b>Application:</b> Drag chain operation, Zones with oils and lubricants, Robot, Drag chain operation</li> </ul>	YF2A28-030UA6XLEAX	2145473
device protection and care			
	<ul style="list-style-type: none"> <li>• <b>Description:</b> Weather hood, 190°</li> <li>• <b>Material:</b> Aluminum</li> <li>• <b>Items supplied:</b> Weather hood, 190°, 3 x M5 x 12 screws</li> <li>• <b>Suitable for:</b> LMS10x, LMS11x, LMS12x, LMS13x, LMS14x, LMS15x, S100</li> </ul>	Weather protection cover 190°	2046459
	<ul style="list-style-type: none"> <li>• <b>Description:</b> Weather protection hood 270°</li> <li>• <b>Material:</b> Aluminum</li> <li>• <b>Items supplied:</b> Weather hood, 270°, 3 x M5 x 12 screws</li> <li>• <b>Suitable for:</b> LMS10x, LMS11x, LMS12x, LMS13x, LMS14x, LMS15x, S100</li> </ul>	Weather protection cover 270°	2046458

## SICK AT A GLANCE

SICK is one of the leading manufacturers of intelligent sensors and sensor solutions for industrial applications. A unique range of products and services creates the perfect basis for controlling processes securely and efficiently, protecting individuals from accidents and preventing damage to the environment.

We have extensive experience in a wide range of industries and understand their processes and requirements. With intelligent sensors, we can deliver exactly what our customers need. In application centers in Europe, Asia and North America, system solutions are tested and optimized in accordance with customer specifications. All this makes us a reliable supplier and development partner.

Comprehensive services complete our offering: SICK LifeTime Services provide support throughout the machine life cycle and ensure safety and productivity.

For us, that is “Sensor Intelligence.”

## WORLDWIDE PRESENCE:

Contacts and other locations –[www.sick.com](http://www.sick.com)