



# WFS3-40N41C

WFS

FORK SENSORS

**SICK**  
Sensor Intelligence.



Illustration may differ



### Ordering information

Type	part no.
WFS3-40N41C	6053766

Other models and accessories → [www.sick.com/WFS](http://www.sick.com/WFS)

### Detailed technical data

#### Features

<b>Functional principle</b>	Optical detection principle
<b>Dimensions (W x H x D)</b>	10 mm x 25 mm x 64.3 mm
<b>Fork width</b>	3 mm
<b>Fork depth</b>	42 mm
<b>Light source</b>	LED, Infrared light
<b>Label detection</b>	✓
<b>Minimum detectable object (MDO)</b>	Gap between Labels / Size of labels: 2 mm <sup>1)</sup>
<b>Adjustment</b>	Plus/minus button, cable (Teach-in, sensitivity, light/dark switching, Teach-in dynamic)
<b>Teach-in mode</b>	2-point teach-in Teach-in dynamic
<b>Safety-related parameters</b>	
	MTTF <sub>D</sub> 97 years
	DC <sub>avg</sub> 0 %

<sup>1)</sup> Depends on the label thickness.

#### Interfaces

<b>IO-Link</b>	✓ , IO-Link V1.1
VendorID	26
DeviceID HEX	80006F
DeviceID DEC	8388719
<b>Cycle time</b>	2.3 ms

## Electronics

<b>Supply voltage</b>	10 V DC ... 30 V DC
<b>Ripple</b>	< 10 %
<b>Current consumption</b>	20 mA <sup>1)</sup>
<b>Initialization time</b>	40 ms
<b>Switching frequency</b>	15 kHz
<b>Response time</b>	≤ 46 μs
<b>Stability of response time</b>	± 20 μs
<b>Jitter</b>	17 μs
<b>Switching output</b>	NPN
<b>Switching output (voltage)</b>	NPN: HIGH = approx. $U_V$ / LOW ≤ 2 V
<b>Switching mode</b>	Light/dark switching
<b>Output current <math>I_{max}</math></b>	100 mA
<b>Input, teach-in (ET)</b>	Teach: $U > 5 V \dots < U_V$
<b>Protection class</b>	III
<b>Circuit protection</b>	$U_V$ connections, reverse polarity protected Output Q short-circuit protected Interference pulse suppression
<b>Connection type</b>	Male connector M8, 4-pin

<sup>1)</sup> Without load.

## Mechanics

<b>Housing material</b>	PA (glass-fiber reinforced)
<b>Weight</b>	Approx. 36 g

## Ambient data

<b>Ambient operating temperature</b>	-20 °C ... +60 °C <sup>1)</sup>
<b>Ambient temperature, storage</b>	-30 °C ... +80 °C
<b>Ambient light immunity</b>	≤ 10,000 lx
<b>Shock load</b>	According to EN 60068-2-27
<b>Enclosure rating</b>	IP65
<b>UL File No.</b>	NRKH.E191603

<sup>1)</sup> Do not bend below 0 °C.

## Certificates

<b>EU declaration of conformity</b>	✓
<b>UK declaration of conformity</b>	✓
<b>ACMA declaration of conformity</b>	✓
<b>Moroccan declaration of conformity</b>	✓
<b>China RoHS</b>	✓
<b>cULus certificate</b>	✓

<b>IO-Link certificate</b>	✓
<b>Information according to Art. 3 of Data Act (Regulation EU 2023/2854)</b>	✓

### Classifications

<b>ECLASS 5.0</b>	27270909
<b>ECLASS 5.1.4</b>	27270909
<b>ECLASS 6.0</b>	27270909
<b>ECLASS 6.2</b>	27270909
<b>ECLASS 7.0</b>	27270909
<b>ECLASS 8.0</b>	27270909
<b>ECLASS 8.1</b>	27270909
<b>ECLASS 9.0</b>	27270909
<b>ECLASS 10.0</b>	27270909
<b>ECLASS 11.0</b>	27270909
<b>ECLASS 12.0</b>	27270909
<b>ETIM 5.0</b>	EC002720
<b>ETIM 6.0</b>	EC002720
<b>ETIM 7.0</b>	EC002720
<b>ETIM 8.0</b>	EC002720
<b>UNSPSC 16.0901</b>	39121528

### Dimensional drawing

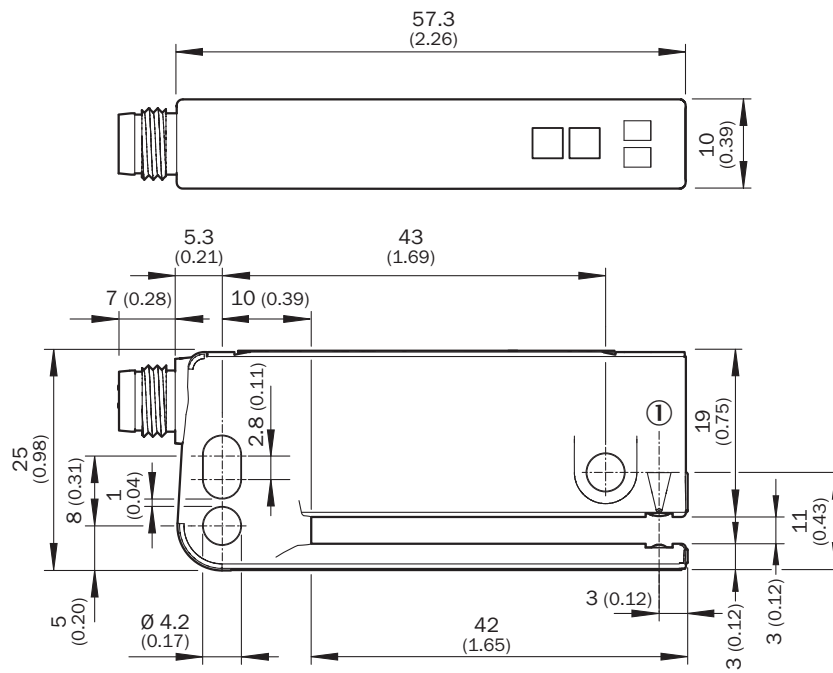

Dimensions in mm (inch)

① Optical axis

### Adjustments WFS, IO-Link

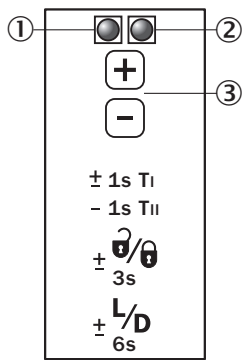

- ① Function signal indicator (yellow)
- ② Power on funktion (green)
- ③ “+”/“-” buttons and function button

### Connection diagram Cd-278

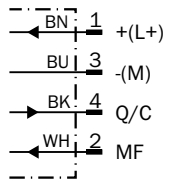

### Concept of operation

**1. Position label or substrate in the active area of the fork sensor**

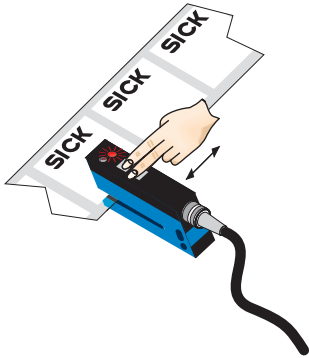

Press both the “+” and “-” buttons together, hold > 1 s and then release the teach-in buttons. The red LED flashes.

**2. Move multiple labels through the fork sensor**

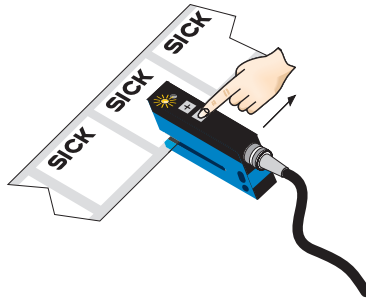

Press “-” button, teach-in process is finished.

### Notes

Switching threshold adaptation:







Only, the first teach-in procedure after switching on is permanently stored. Teach-in can be repeated cyclically. Switching output also during teach-in active.

- + Once teach-in process is complete, the switching threshold can be adjusted at any time using the “+” or “-” button. To make minor adjustments, press the “+” or “-” button once. To configure settings quickly, keep the “+” or “-” button pressed for longer.
- ± Press both the “+” and “-” buttons together (3 seconds) to lock the device and prevent unintentional actuation.
- ± Press both the “+” and “-” buttons together (6 seconds) to define the switching function (light/dark switching). Standard setting: Q = light switching.

Teach-in (static): Setting the switching threshold without movements of label, cf. operating instruction.

## Recommended accessories

Other models and accessories → [www.sick.com/WFS](http://www.sick.com/WFS)

	Brief description	Type	part no.
network devices			
		IOLA2US-01101 (SiLink2 Master)	1061790
		SIG200-0A0412200	1089794
		SIG200-0A0G12200	1102605
Mounting systems			
	<ul style="list-style-type: none"> <li>• <b>Description:</b> WFS mounting rod, straight, including 2 x fixing screws</li> <li>• <b>Material:</b> Steel</li> <li>• <b>Details:</b> Aluminum</li> </ul>	BEF-M12GF-A	2059414
connectors and cables			
	<ul style="list-style-type: none"> <li>• <b>Description:</b> Unshielded</li> <li>• <b>Connection type head A:</b> Male connector, M8, 4-pin, straight, A-coded</li> <li>• <b>Connection systems:</b> Screw-type terminals</li> <li>• <b>Permitted cross-section:</b> 0.14 mm<sup>2</sup> ... 0.5 mm<sup>2</sup></li> </ul>	STE-0804-G	6037323
	<ul style="list-style-type: none"> <li>• <b>Connection type head A:</b> Female connector, M8, 4-pin, straight, A-coded</li> <li>• <b>Connection type head B:</b> Flying leads</li> <li>• <b>Signal type:</b> Sensor/actuator cable</li> <li>• <b>Cable:</b> 5 m, 4-wire, PVC</li> <li>• <b>Description:</b> Sensor/actuator cable, unshielded</li> <li>• <b>Application:</b> Uncontaminated zones, Zones with chemicals</li> </ul>	YF8U14-050VA3XLEAX	2095889

## SICK AT A GLANCE

SICK is one of the leading manufacturers of intelligent sensors and sensor solutions for industrial applications. A unique range of products and services creates the perfect basis for controlling processes securely and efficiently, protecting individuals from accidents and preventing damage to the environment.

We have extensive experience in a wide range of industries and understand their processes and requirements. With intelligent sensors, we can deliver exactly what our customers need. In application centers in Europe, Asia and North America, system solutions are tested and optimized in accordance with customer specifications. All this makes us a reliable supplier and development partner.

Comprehensive services complete our offering: SICK LifeTime Services provide support throughout the machine life cycle and ensure safety and productivity.

For us, that is “Sensor Intelligence.”

## WORLDWIDE PRESENCE:

Contacts and other locations –[www.sick.com](http://www.sick.com)