

# DFS60B-S4UA02500

DFS60

**INCREMENTAL ENCODERS**

**SICK**  
Sensor Intelligence.

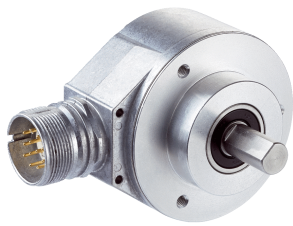

### Ordering information

| Type             | part no. |
|------------------|----------|
| DFS60B-S4UA02500 | 1057254  |

Other models and accessories → [www.sick.com/DFS60](http://www.sick.com/DFS60)

Illustration may differ



### Detailed technical data

#### Safety-related parameters

|  |  |
|--|--|
| <b>MTTF<sub>D</sub> (mean time to dangerous failure)</b> | 300 years (EN ISO 13849-1) <sup>1)</sup> |
|--|--|

<sup>1)</sup> This product is a standard product and does not constitute a safety component as defined in the Machinery Directive. Calculation based on nominal load of components, average ambient temperature 40°C, frequency of use 8760 h/a. All electronic failures are considered hazardous. For more information, see document no. 8015532.

#### Performance

|   |                                     |
|---|-------------------------------------|
| <b>Pulses per revolution</b>                                  | 2,500 <sup>1)</sup>                 |
| <b>Measuring step</b>   | 90°, electric/pulses per revolution |
| <b>Measuring step deviation at non binary number of lines</b> | ± 0.01°                             |
| <b>Error limits</b>   | ± 0.05°                             |

<sup>1)</sup> See maximum revolution range.

#### Interfaces

|  |   |
|--|---|
| <b>Communication interface</b>         | Incremental   |
| <b>Communication Interface detail</b>  | TTL / RS-422  |
| <b>Number of signal channels</b>       | 6-channel   |
| <b>0-set function via hardware pin</b> | ✓   |
| <b>0-SET function</b>                  | H-active, L = 0 - 3 V, H = 4,0 - U <sub>s</sub> V <sup>1)</sup> |
| <b>Initialization time</b>             | 30 ms   |
| <b>Output frequency</b>                | ≤ 600 kHz   |
| <b>Load current</b>                    | ≤ 30 mA   |
| <b>Operating current</b>               | 40 mA (without load)  |

<sup>1)</sup> Only with devices with M23 connector in connection with electrical interfaces M, U, V and W.

#### Electronics

|                        |                                     |
|------------------------|-------------------------------------|
| <b>Connection type</b> | Male connector, M23, 12-pin, radial |
| <b>Supply voltage</b>  | 4.5 ... 5.5 V                       |

<sup>1)</sup> Short-circuit opposite to another channel, US or GND permissible for maximum 30 s.

|  |   |
|--|---|
| <b>Reference signal, number</b>                | 1   |
| <b>Reference signal, position</b>              | 90°, electric, logically gated with A and B |
| <b>Reverse polarity protection</b>             | ✓   |
| <b>Short-circuit protection of the outputs</b> | ✓ <sup>1)</sup>                             |

<sup>1)</sup> Short-circuit opposite to another channel, US or GND permissible for maximum 30 s.

## Mechanics

|                                       |   |
|---------------------------------------|---|
| <b>Mechanical design</b>              | Solid shaft, face mount flange          |
| <b>Shaft diameter</b>                 | 10 mm<br>With flat                      |
| <b>Shaft length</b>                   | 19 mm                                   |
| <b>Weight</b>                         | + 0.3 kg                                |
| <b>Shaft material</b>                 | Stainless steel                         |
| <b>Flange material</b>                | Aluminum                                |
| <b>Housing material</b>               | Aluminum die cast                       |
| <b>Start up torque</b>                | 0.5 Ncm (+20 °C)                        |
| <b>Operating torque</b>               | 0.3 Ncm (+20 °C)                        |
| <b>Permissible shaft loading</b>      | 80 N (radial)<br>40 N (axial)           |
| <b>Operating speed</b>                | ≤ 9,000 min <sup>-1</sup> <sup>1)</sup> |
| <b>Moment of inertia of the rotor</b> | 6.2 gcm <sup>2</sup>                    |
| <b>Bearing lifetime</b>               | 3.6 x 10 <sup>10</sup> revolutions      |
| <b>Angular acceleration</b>           | ≤ 500,000 rad/s <sup>2</sup>            |

<sup>1)</sup> Allow for self-heating of 3.3 K per 1,000 rpm when designing the operating temperature range.

## Ambient data

|                                      |  |
|--------------------------------------|--|
| <b>EMC</b>                           | According to EN 61000-6-2 and EN 61000-6-3   |
| <b>Enclosure rating</b>              | IP67, Housing side, male connector (IEC 60529) <sup>1)</sup><br>IP65, shaft side (IEC 60529) |
| <b>Permissible relative humidity</b> | 90 % (Condensation not permitted)  |
| <b>Operating temperature range</b>   | -40 °C ... +100 °C <sup>2)</sup><br>-30 °C ... +100 °C <sup>3)</sup>                         |
| <b>Storage temperature range</b>     | -40 °C ... +100 °C, without package  |
| <b>Resistance to shocks</b>          | 70 g, 6 ms (EN 60068-2-27)   |
| <b>Resistance to vibration</b>       | 30 g, 10 Hz ... 2,000 Hz (EN 60068-2-6)  |

<sup>1)</sup> With mating connector fitted.

<sup>2)</sup> Stationary position of the cable.

<sup>3)</sup> Flexible position of the cable.

## Certificates

|   |   |
|---|---|
| <b>EU declaration of conformity</b>       | ✓ |
| <b>UK declaration of conformity</b>       | ✓ |
| <b>ACMA declaration of conformity</b>     | ✓ |
| <b>Moroccan declaration of conformity</b> | ✓ |
| <b>China RoHS</b>                         | ✓ |

|  |   |
|--|---|
| <b>cULus certificate</b>   | ✓ |
| <b>Information according to Art. 3 of Data Act (Regulation EU 2023/2854)</b> | ✓ |

### Classifications

|                       |          |
|-----------------------|----------|
| <b>ECLASS 5.0</b>     | 27270501 |
| <b>ECLASS 5.1.4</b>   | 27270501 |
| <b>ECLASS 6.0</b>     | 27270590 |
| <b>ECLASS 6.2</b>     | 27270590 |
| <b>ECLASS 7.0</b>     | 27270501 |
| <b>ECLASS 8.0</b>     | 27270501 |
| <b>ECLASS 8.1</b>     | 27270501 |
| <b>ECLASS 9.0</b>     | 27270501 |
| <b>ECLASS 10.0</b>    | 27270501 |
| <b>ECLASS 11.0</b>    | 27270501 |
| <b>ECLASS 12.0</b>    | 27270501 |
| <b>ETIM 5.0</b>       | EC001486 |
| <b>ETIM 6.0</b>       | EC001486 |
| <b>ETIM 7.0</b>       | EC001486 |
| <b>ETIM 8.0</b>       | EC001486 |
| <b>UNSPSC 16.0901</b> | 41112113 |

### Dimensional drawing

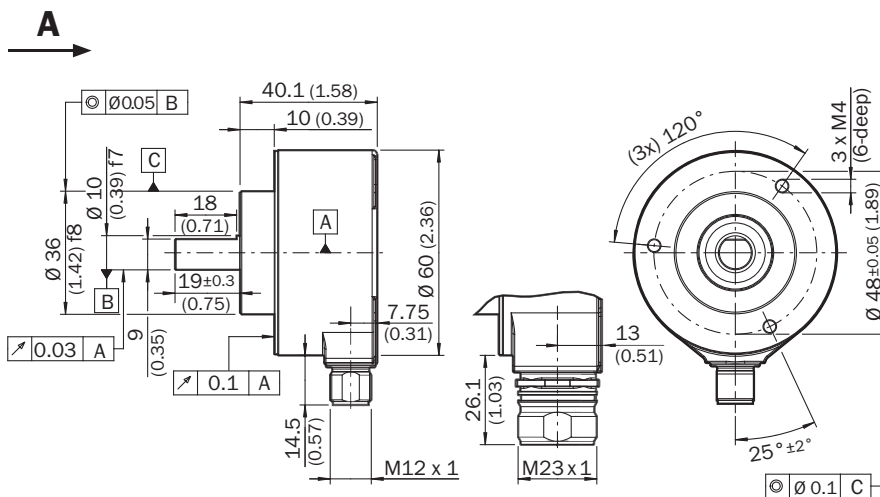

Dimensions in mm (inch)

## PIN assignment

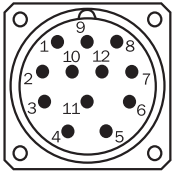

view of M23 male device connector on encoder

| PIN Male connector M12, 8-pin | PIN Male connector M23, 12-pin | Wire colors (cable connection) | TTL/HTL signal      | Sin/Cos 1.0 V <sub>PP</sub> | Explanation   |
|-------------------------------|--------------------------------|--------------------------------|---------------------|-----------------------------|---|
| 1                             | 6                              | Brown                          | $\bar{A}$           | COS-                        | Signal wire   |
| 2                             | 5                              | White                          | A                   | COS+                        | Signal wire   |
| 3                             | 1                              | Black                          | $\bar{B}$           | SIN-                        | Signal wire   |
| 4                             | 8                              | Pink                           | B                   | SIN+                        | Signal wire   |
| 5                             | 4                              | Yellow                         | $\bar{Z}$           | $\bar{Z}$                   | Signal wire   |
| 6                             | 3                              | Purple                         | Z                   | Z                           | Signal wire   |
| 7                             | 10                             | Blue                           | GND                 | GND                         | Ground connection   |
| 8                             | 12                             | Red                            | +U <sub>S</sub>     | +U <sub>S</sub>             | Supply voltage  |
| -                             | 9                              | -                              | N.c.                | N.c.                        | Not assigned  |
| -                             | 2                              | -                              | N.c.                | N.c.                        | Not assigned  |
| -                             | 11                             | -                              | N.c.                | N.c.                        | Not assigned  |
| -                             | 7 <sup>1)</sup>                | Orange                         | O-SET <sup>1)</sup> | N.c.                        | Set zero pulse <sup>1)</sup>  |
| Screen                        | Screen                         | Screen                         | Screen              | Screen                      | Screen connected to housing on encoder side. Connected to ground on control side. |

<sup>1)</sup>For electrical interfaces only: M, U, V, W with O-SET function on PIN 7 on M23 plug. The O-SET input is used to set the zero pulse to the current shaft position. If the O-SET input is applied to US for longer than 250 ms after it has previously been open or applied to GND for at least 1,000 ms, the current shaft position is assigned zero pulse signal "Z".

### maximum revolution range

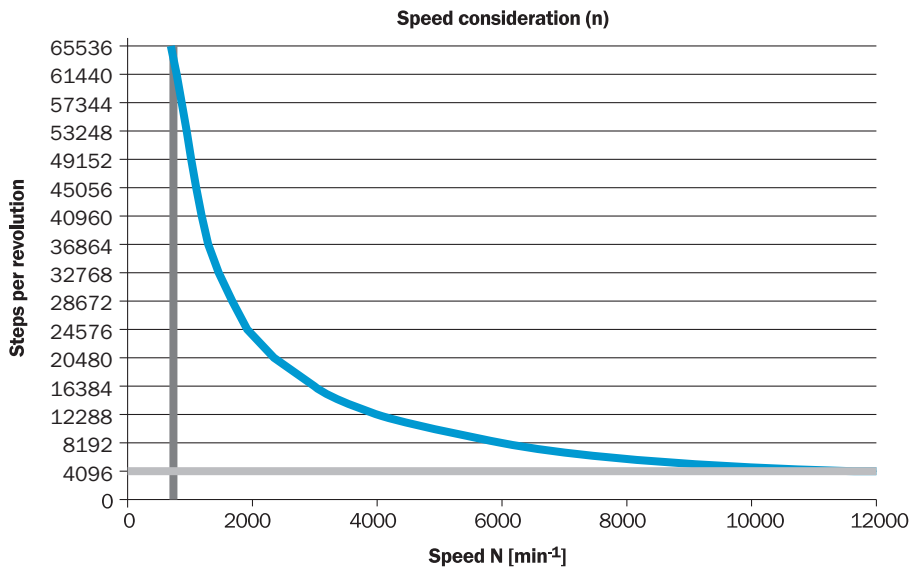

### signal outputs

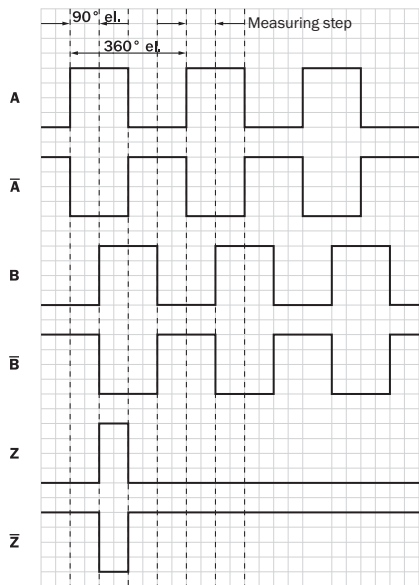











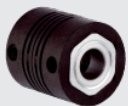



CW with view on the encoder shaft in direction "A", compare dimensional drawing.

| Supply voltage  | Output |
|-----------------|--------|
| 4,5 V ... 5,5 V | TTL    |
| 10 V ... 32 V   | TTL    |
| 10 V ... 32 V   | HTL    |



## Recommended accessories

Other models and accessories → [www.sick.com/DFS60](http://www.sick.com/DFS60)

|   | Brief description   | Type       | part no. |
|---|---|------------|----------|
| shaft adaptation  |   |            |          |
|    | <ul style="list-style-type: none"> <li><b>Product segment:</b> Shaft adaptation</li> <li><b>Product:</b> Shaft couplings</li> <li><b>Description:</b> Bellows coupling, shaft diameter 6 mm / 10 mm, maximum shaft offset: radial <math>\pm 0.25</math> mm, axial <math>\pm 0.4</math> mm, angular <math>\pm 4^\circ</math>; max. speed 10,000 rpm, <math>-30^\circ\text{C}</math> to <math>+120^\circ\text{C}</math>, max. torque 120 Ncm; material: stainless steel bellows, aluminum hub</li> </ul>  | KUP-0610-B | 5312982  |
|    | <ul style="list-style-type: none"> <li><b>Product segment:</b> Shaft adaptation</li> <li><b>Product:</b> Shaft couplings</li> <li><b>Description:</b> Double loop coupling, shaft diameter 6 mm / 10 mm, max. shaft offset: radially <math>\pm 2.5</math> mm, axially <math>\pm 3</math> mm, angle <math>\pm 10</math> degrees; max. speed 3,000 rpm, <math>-30</math> to <math>+80</math> degrees Celsius, torsional spring stiffness of 25 Nm/rad</li> </ul>  | KUP-0610-D | 5326697  |
|    | <ul style="list-style-type: none"> <li><b>Product segment:</b> Shaft adaptation</li> <li><b>Product:</b> Shaft couplings</li> <li><b>Description:</b> Spring washer coupling, shaft diameter 6 mm / 10 mm, Maximum shaft offset: radial <math>\pm 0.3</math> mm, axial <math>\pm 0.4</math> mm, angular <math>\pm 2.5^\circ</math>; max. speed 12,000 rpm, <math>-10^\circ</math> to <math>+80^\circ\text{C}</math>, max. torque 60 Ncm; material: aluminum flange, glass fiber-reinforced polyamide membrane and hardened steel coupling pin</li> </ul>  | KUP-0610-F | 5312985  |
|    | <ul style="list-style-type: none"> <li><b>Product segment:</b> Shaft adaptation</li> <li><b>Product:</b> Shaft couplings</li> <li><b>Description:</b> Bar coupling, shaft diameter 6 mm / 10 mm, max. shaft offset: radial <math>\pm 0.3</math> mm, axial <math>\pm 0.3</math> mm, angular <math>\pm 3^\circ</math>; max. speed 10,000 rpm, <math>-10^\circ</math> to <math>+80^\circ\text{C}</math>, max. torque: 80 Ncm, material: fiber-glass reinforced polyamide, aluminum hub</li> </ul>  | KUP-0610-S | 2056407  |
|    | <ul style="list-style-type: none"> <li><b>Product segment:</b> Shaft adaptation</li> <li><b>Product:</b> Shaft couplings</li> <li><b>Description:</b> Claw coupling, shaft diameter 6 mm / 10 mm, damping element 80 shore blue, maximum shaft offset: radial <math>\pm 0.22</math> mm, axial <math>\pm 1</math> mm angular <math>\pm 1.3^\circ</math>, max. speed 19,000 rpm, angle of twist max. <math>10^\circ</math>, <math>-30^\circ\text{C}</math> to <math>+80^\circ\text{C}</math>, max. torque 800 Ncm, tightening torque of screws: ISO 4029 150 Ncm, material: aluminum flange, damping element: polyurethane</li> </ul> | KUP-0610-J | 2127056  |
|  | <ul style="list-style-type: none"> <li><b>Product segment:</b> Shaft adaptation</li> <li><b>Product:</b> Shaft couplings</li> <li><b>Description:</b> Double loop coupling, shaft diameter 8 mm / 10 mm, max. shaft offset: radially <math>\pm 0.25</math> mm, axially <math>\pm 0.4</math> mm, angle <math>\pm 4</math> degrees; max. speed 10,000 rpm, <math>-30</math> to <math>+120</math> degrees Celsius, torsional spring stiffness of 150 Nm/rad</li> </ul>   | KUP-0810-D | 5326704  |
|  | <ul style="list-style-type: none"> <li><b>Product segment:</b> Shaft adaptation</li> <li><b>Product:</b> Shaft couplings</li> <li><b>Description:</b> Bar coupling, shaft diameter 8 mm / 10 mm, max. shaft offset: radial <math>\pm 0.3</math> mm, axial <math>\pm 0.3</math> mm, angular <math>\pm 3^\circ</math>; max. speed 10,000 rpm, <math>-10^\circ</math> to <math>+80^\circ\text{C}</math>, max. torque: 80 Ncm, material: fiber-glass reinforced polyamide, aluminum hub</li> </ul>  | KUP-0810-S | 5314178  |
|  | <ul style="list-style-type: none"> <li><b>Product segment:</b> Shaft adaptation</li> <li><b>Product:</b> Shaft couplings</li> <li><b>Description:</b> Bellows coupling, shaft diameter 10 mm/10 mm; maximum shaft offset: radial <math>\pm 0.25</math> mm, axial <math>\pm 0.4</math> mm, angular <math>\pm 4^\circ</math>; max. revolutions 10,000 rpm, <math>-30^\circ</math> to <math>+120^\circ\text{C}</math>, max. torque 120 Ncm; material: stainless steel bellows, aluminum clamping hubs</li> </ul>   | KUP-1010-B | 5312983  |
|  | <ul style="list-style-type: none"> <li><b>Product segment:</b> Shaft adaptation</li> <li><b>Product:</b> Shaft couplings</li> <li><b>Description:</b> Double loop coupling, shaft diameter 10 mm / 10 mm, Maximum shaft offset: radial <math>\pm 2.5</math> mm, axial <math>\pm 3</math> mm, angular <math>\pm 10^\circ</math>; max. speed 3,000 rpm, <math>-30^\circ</math> to <math>+80^\circ\text{C}</math>, max. torque 1.5 Nm; material: polyurethane, galvanized steel flange</li> </ul>  | KUP-1010-D | 5326703  |
|  | <ul style="list-style-type: none"> <li><b>Product segment:</b> Shaft adaptation</li> <li><b>Product:</b> Shaft couplings</li> <li><b>Description:</b> Spring washer coupling, shaft diameter 10 mm / 10 mm, maximum shaft offset, radial <math>\pm 0.3</math> mm, axial <math>\pm 0.4</math> mm, angle <math>\pm 2.5^\circ</math>, torsion spring stiffness 30 Nm/rad; material: aluminum flange, glass-fiber reinforced polyamide membrane and hardened steel coupling pin</li> </ul>  | KUP-1010-F | 5312986  |
|  | <ul style="list-style-type: none"> <li><b>Product segment:</b> Shaft adaptation</li> <li><b>Product:</b> Shaft couplings</li> <li><b>Description:</b> Bar coupling, shaft diameter 10 mm / 10 mm; maximum shaft offset: radial <math>\pm 0.3</math> mm, axial <math>\pm 0.2</math> mm, angular <math>\pm 3^\circ</math>; speed 10,000 rpm, <math>-10^\circ</math> to <math>+80^\circ\text{C}</math>, max. torque 80 Ncm; material: glass fiber-reinforced polyamide, aluminum hub</li> </ul>  | KUP-1010-S | 2056408  |
|  | <ul style="list-style-type: none"> <li><b>Product segment:</b> Shaft adaptation</li> <li><b>Product:</b> Shaft couplings</li> </ul>   | KUP-1012-B | 5312984  |

|   | Brief description   | Type       | part no. |
|---|---|------------|----------|
|  | <ul style="list-style-type: none"> <li><b>Description:</b> 10 mm / 12 mm; maximum shaft offset: radial +/- 0.25 mm, axial +/- 0.4 mm, angular +/- 4°; max. revolutions 10,000 rpm, -30° to +120 °C, max. torque 120 Ncm; material: stainless steel bellows, aluminum clamping hubs</li> <li><b>Product segment:</b> Shaft adaptation</li> <li><b>Product:</b> Shaft couplings</li> <li><b>Description:</b> Double loop coupling, shaft diameter 10 mm / 12 mm, Maximum shaft offset: radial +/- 2.5 mm, axial +/- 3 mm, angular +/- 10°; max. speed 3,000 rpm, -30° to +80 °C, max. torque 1.5 Nm; material: polyurethane, galvanized steel flange</li> </ul> | KUP-1012-D | 5326702  |
|  | <ul style="list-style-type: none"> <li><b>Product segment:</b> Shaft adaptation</li> <li><b>Product:</b> Shaft couplings</li> <li><b>Description:</b> Claw coupling, shaft diameter 8 mm / 10 mm, damping element 80 shore blue, maximum shaft offset: radial ± 0.22 mm, axial ± 1 mm angular ± 1.3°, max. speed 19,000 rpm, angle of twist max. 10°, -30 °C to +80 °C, max. torque 800 Ncm, tightening torque of screws: ISO 4029 150 Ncm, material: aluminum flange, damping element: polyurethane</li> </ul>   | KUP-0810-J | 2128267  |
|  | <ul style="list-style-type: none"> <li><b>Product segment:</b> Shaft adaptation</li> <li><b>Product:</b> Shaft couplings</li> <li><b>Description:</b> Claw coupling, shaft diameter 10 mm / 10 mm, damping element 80 shore blue, maximum shaft offset: radial ± 0.22 mm, axial ± 1 mm angular ± 1.3°, max. speed 19,000 rpm, angle of twist max. 10°, -30 °C to +80 °C, max. torque 800 Ncm, tightening torque of screws: ISO 4029 150 Ncm, material: aluminum flange, damping element: polyurethane</li> </ul>  | KUP-1010-J | 2127054  |
|  | <ul style="list-style-type: none"> <li><b>Product segment:</b> Shaft adaptation</li> <li><b>Product:</b> Shaft couplings</li> <li><b>Description:</b> Claw coupling, shaft diameter 10 mm / 12 mm, damping element 80 shore blue, maximum shaft offset: radial ± 0.22 mm, axial ± 1 mm angular ± 1.3°, max. speed 19,000 rpm, angle of twist max. 10°, -30 °C to +80 °C, max. torque 800 Ncm, tightening torque of screws: ISO 4029 150 Ncm, material: aluminum flange, damping element: polyurethane</li> </ul>  | KUP-1012-J | 2128265  |







|   | Brief description   | Type           | part no. |
|---|---|----------------|----------|
| measuring wheels and measuring wheel mechanics                                    |   |                |          |
|  | <ul style="list-style-type: none"> <li>• <b>Product segment:</b> Measuring wheels and measuring wheel mechanics</li> <li>• <b>Product:</b> Measuring wheels</li> <li>• <b>Description:</b> Aluminum measuring wheel with studded polyurethane surface for 6 mm solid shaft, circumference 200 mm</li> </ul>   | BEF-MR06200APN | 4084747  |
|  | <ul style="list-style-type: none"> <li>• <b>Product segment:</b> Measuring wheels and measuring wheel mechanics</li> <li>• <b>Product:</b> Measuring wheel mechanics</li> <li>• <b>Description:</b> SICK modular measuring wheel system for face mount flange encoder with S4 mechanical design (10 mm x 19 mm solid shaft), e.g., DFS60-S4: with O-ring measuring wheel, circumference 200 mm</li> </ul> | BEF-MRS-10-U   | 2085714  |

|   | Brief description  | Type           | part no. |
|---|--|----------------|----------|
|   | <ul style="list-style-type: none"> <li><b>Suitable for:</b> Face mount flange encoder DFS60, DBS60, AFM60, AFS60, mechanical design S4 (solid shaft 10 mm x 19 mm)</li> </ul>  |                |          |
|    | <ul style="list-style-type: none"> <li><b>Product segment:</b> Measuring wheels and measuring wheel mechanics</li> <li><b>Product:</b> Measuring wheels</li> <li><b>Description:</b> Aluminium measuring wheel with O-ring (NBR70) for 10 mm solid shaft, circumference 200 mm</li> </ul>              | BEF-MR010020R  | 2055224  |
|    | <ul style="list-style-type: none"> <li><b>Product segment:</b> Measuring wheels and measuring wheel mechanics</li> <li><b>Product:</b> Measuring wheels</li> <li><b>Description:</b> Aluminium measuring wheel with O-ring (NBR70) for 10 mm solid shaft, circumference 300 mm</li> </ul>              | BEF-MR010030R  | 2049278  |
|    | <ul style="list-style-type: none"> <li><b>Product segment:</b> Measuring wheels and measuring wheel mechanics</li> <li><b>Product:</b> Measuring wheels</li> <li><b>Description:</b> Measuring wheel with O-ring (NBR70) for 10 mm solid shaft, circumference 500 mm</li> </ul>                        | BEF-MR010050R  | 2055227  |
|   | <ul style="list-style-type: none"> <li><b>Product segment:</b> Measuring wheels and measuring wheel mechanics</li> <li><b>Product:</b> Measuring wheels</li> <li><b>Description:</b> Aluminum measuring wheel with cross-knurl surface for 10 mm solid shaft, circumference 200 mm</li> </ul>          | BEF-MR10200AK  | 4084737  |
|  | <ul style="list-style-type: none"> <li><b>Product segment:</b> Measuring wheels and measuring wheel mechanics</li> <li><b>Product:</b> Measuring wheels</li> <li><b>Description:</b> Aluminum measuring wheel with smooth polyurethane surface for 10 mm solid shaft, circumference 200 mm</li> </ul>  | BEF-MR10200AP  | 4084738  |
|  | <ul style="list-style-type: none"> <li><b>Product segment:</b> Measuring wheels and measuring wheel mechanics</li> <li><b>Product:</b> Measuring wheels</li> <li><b>Description:</b> Aluminum measuring wheel with studded polyurethane surface for 10 mm solid shaft, circumference 200 mm</li> </ul> | BEF-MR10200APN | 4084739  |
|  | <ul style="list-style-type: none"> <li><b>Product segment:</b> Measuring wheels and measuring wheel mechanics</li> <li><b>Product:</b> Measuring wheels</li> <li><b>Description:</b> Aluminum measuring wheel with cross-knurl surface for 10 mm solid shaft, circumference 500 mm</li> </ul>          | BEF-MR10500AK  | 4084733  |
|  | <ul style="list-style-type: none"> <li><b>Product segment:</b> Measuring wheels and measuring wheel mechanics</li> <li><b>Product:</b> Measuring wheels</li> <li><b>Description:</b> Aluminum measuring wheel with smooth polyurethane surface for 10 mm solid shaft, circumference 500 mm</li> </ul>  | BEF-MR10500AP  | 4084734  |
|  | <ul style="list-style-type: none"> <li><b>Product segment:</b> Measuring wheels and measuring wheel mechanics</li> <li><b>Product:</b> Measuring wheels</li> <li><b>Description:</b> Aluminum measuring wheel with ridged polyurethane surface for 10 mm solid shaft, circumference 500 mm</li> </ul>  | BEF-MR10500APG | 4084736  |

|   | Brief description  | Type               | part no. |
|---|--|--------------------|----------|
| Mounting systems  |  |                    |          |
|    | <ul style="list-style-type: none"> <li><b>Description:</b> Bearing block for servo and face mount flange encoder. The heavy-duty bearing block is used to absorb very large radial and axial shaft loads. Particularly when using belt pulleys, chain sprockets, friction wheels. Operating speed max. 4,000 rpm<sup>-1</sup>, axial shaft load 150 N, radial shaft load 250 N, bearing service life 3.6 x 10<sup>9</sup> revolutions</li> </ul> | BEF-FA-LB1210      | 2044591  |
|    | <ul style="list-style-type: none"> <li><b>Description:</b> Mounting bracket for encoder with spigot 36 mm for face mount flange</li> <li><b>Items supplied:</b> Mounting kit included</li> </ul>   | BEF-WF-36          | 2029164  |
|    | <ul style="list-style-type: none"> <li><b>Description:</b> Flange adapter, adaptation of face mount flange with 36 mm centering hub to 50 mm servo flange, aluminum, including 3 flat head screws M4 x 10</li> <li><b>Material:</b> Aluminum</li> <li><b>Details:</b> Aluminum</li> <li><b>Items supplied:</b> Including 3 countersunk screws M3 x 10</li> </ul>   | BEF-FA-036-050     | 2029160  |
|    | <ul style="list-style-type: none"> <li><b>Description:</b> Flange adapter, adaptation of face mount flange with 36 mm centering hub to 60 mm square mounting plate, aluminum, including 3 flat head screws M4 x 8</li> <li><b>Material:</b> Aluminum</li> <li><b>Details:</b> Aluminum</li> <li><b>Items supplied:</b> Including 3 countersunk screws M4 x 8</li> </ul>  | BEF-FA-036-060REC  | 2029162  |
|  | <ul style="list-style-type: none"> <li><b>Description:</b> Flange adapter, adaptation of face mount flange with 36 mm centering hub to 58 mm square mounting plate with shock absorbers, aluminum</li> <li><b>Material:</b> Aluminum</li> <li><b>Details:</b> Aluminum</li> </ul>  | BEF-FA-036-060RSA  | 2029163  |
|  | <ul style="list-style-type: none"> <li><b>Description:</b> Flange adapter, adaptation of face mount flange with 36 mm centering hub to 63 mm square mounting plate, aluminum, including 3 flat head screws M4 x 8</li> <li><b>Material:</b> Aluminum</li> <li><b>Details:</b> Aluminum</li> <li><b>Items supplied:</b> Including 3 countersunk screws M4 x 8</li> </ul>  | BEF-FA-036-063REC  | 2034225  |
|  | <ul style="list-style-type: none"> <li><b>Description:</b> Flange adapter, adaptation of face mount flange with 36 mm centering hub to 100 mm servo flange with 60 mm centering hub, aluminum</li> <li><b>Material:</b> Aluminum</li> <li><b>Details:</b> Aluminum</li> </ul>  | BEF-FA-036-100     | 2029161  |
|  | <ul style="list-style-type: none"> <li><b>Description:</b> Flange adapter (adapts size 60 face mount flange encoder to bearing block with part. no. 2044591)</li> </ul>  | BEF-FA-036-050-019 | 2063378  |
|  | <ul style="list-style-type: none"> <li><b>Description:</b> Mounting angle spring-loaded, for flange with centerring collar 36 mm, working temperature range -40° ... +120° C</li> <li><b>Material:</b> Aluminum</li> <li><b>Details:</b> Aluminum</li> </ul>   | BEF-WF36F          | 4084775  |

|   | Brief description  | Type             | part no. |
|---|--|------------------|----------|
| connectors and cables   |  |                  |          |
|    | <ul style="list-style-type: none"> <li>• <b>Connection type head A:</b> Female connector, M23, 12-pin, straight</li> <li>• <b>Connection type head B:</b> Flying leads</li> <li>• <b>Signal type:</b> Incremental</li> <li>• <b>Cable:</b> 15 m, 11-wire, PUR</li> <li>• <b>Description:</b> Incremental, shielded</li> <li>• <b>Application:</b> Zones with oils and lubricants</li> </ul>                | DOL-2312-G15MLD1 | 2062205  |
|    | <ul style="list-style-type: none"> <li>• <b>Connection type head A:</b> Female connector, M23, 12-pin, straight</li> <li>• <b>Connection type head B:</b> Flying leads</li> <li>• <b>Signal type:</b> Incremental</li> <li>• <b>Cable:</b> 2 m, 11-wire, PUR</li> <li>• <b>Description:</b> Incremental, shielded</li> <li>• <b>Application:</b> Zones with oils and lubricants</li> </ul>                 | DOL-2312-G02MLD1 | 2062202  |
|    | <ul style="list-style-type: none"> <li>• <b>Connection type head A:</b> Female connector, M23, 12-pin, straight</li> <li>• <b>Connection type head B:</b> Flying leads</li> <li>• <b>Signal type:</b> Incremental</li> <li>• <b>Cable:</b> 7 m, 11-wire, PUR</li> <li>• <b>Description:</b> Incremental, shielded</li> <li>• <b>Application:</b> Zones with oils and lubricants</li> </ul>                 | DOL-2312-G07MLD1 | 2062203  |
|    | <ul style="list-style-type: none"> <li>• <b>Connection type head A:</b> Female connector, M23, 12-pin, straight</li> <li>• <b>Connection type head B:</b> Flying leads</li> <li>• <b>Signal type:</b> Incremental</li> <li>• <b>Cable:</b> 10 m, 11-wire, PUR</li> <li>• <b>Description:</b> Incremental, shielded</li> <li>• <b>Application:</b> Zones with oils and lubricants</li> </ul>                | DOL-2312-G10MLD1 | 2062204  |
|    | <ul style="list-style-type: none"> <li>• <b>Connection type head A:</b> Female connector, M23, 12-pin, straight</li> <li>• <b>Connection type head B:</b> Flying leads</li> <li>• <b>Signal type:</b> Incremental</li> <li>• <b>Cable:</b> 20 m, 11-wire, PUR</li> <li>• <b>Description:</b> Incremental, shielded</li> <li>• <b>Application:</b> Zones with oils and lubricants</li> </ul>                | DOL-2312-G20MLD1 | 2062206  |
|   | <ul style="list-style-type: none"> <li>• <b>Connection type head A:</b> Female connector, M23, 12-pin, straight</li> <li>• <b>Connection type head B:</b> Flying leads</li> <li>• <b>Signal type:</b> Incremental</li> <li>• <b>Cable:</b> 25 m, 11-wire, PUR</li> <li>• <b>Description:</b> Incremental, shielded</li> <li>• <b>Application:</b> Zones with oils and lubricants</li> </ul>                | DOL-2312-G25MLD1 | 2062207  |
|  | <ul style="list-style-type: none"> <li>• <b>Connection type head A:</b> Female connector, M23, 12-pin, straight</li> <li>• <b>Connection type head B:</b> Flying leads</li> <li>• <b>Signal type:</b> Incremental</li> <li>• <b>Cable:</b> 30 m, 11-wire, PUR</li> <li>• <b>Description:</b> Incremental, shielded</li> <li>• <b>Application:</b> Zones with oils and lubricants</li> </ul>                | DOL-2312-G30MLD1 | 2062208  |
|  | <ul style="list-style-type: none"> <li>• <b>Connection type head A:</b> Female connector, M23, 12-pin, straight</li> <li>• <b>Connection type head B:</b> Flying leads</li> <li>• <b>Signal type:</b> Incremental</li> <li>• <b>Cable:</b> 1.5 m, 12-wire, PUR, halogen-free</li> <li>• <b>Description:</b> Incremental, shielded</li> <li>• <b>Application:</b> Zones with oils and lubricants</li> </ul> | DOL-2312-G1M5MD1 | 2062240  |
|  | <ul style="list-style-type: none"> <li>• <b>Connection type head A:</b> Female connector, M23, 12-pin, straight</li> <li>• <b>Connection type head B:</b> Flying leads</li> <li>• <b>Signal type:</b> Incremental</li> <li>• <b>Cable:</b> 3 m, 12-wire, PUR, halogen-free</li> <li>• <b>Description:</b> Incremental, shielded</li> <li>• <b>Application:</b> Zones with oils and lubricants</li> </ul>   | DOL-2312-G03MMD1 | 2062243  |
|  | <ul style="list-style-type: none"> <li>• <b>Connection type head A:</b> Female connector, M23, 12-pin, straight</li> <li>• <b>Connection type head B:</b> Flying leads</li> <li>• <b>Signal type:</b> Incremental</li> <li>• <b>Cable:</b> 5 m, 12-wire, PUR, halogen-free</li> <li>• <b>Description:</b> Incremental, shielded</li> <li>• <b>Application:</b> Zones with oils and lubricants</li> </ul>   | DOL-2312-G05MMD1 | 2062244  |
|  | <ul style="list-style-type: none"> <li>• <b>Connection type head A:</b> Female connector, M23, 12-pin, straight</li> <li>• <b>Connection type head B:</b> Flying leads</li> <li>• <b>Signal type:</b> Incremental</li> <li>• <b>Cable:</b> 10 m, 12-wire, PUR, halogen-free</li> <li>• <b>Description:</b> Incremental, shielded</li> </ul>  | DOL-2312-G10MMD1 | 2062245  |

|   | Brief description   | Type             | part no. |
|---|---|------------------|----------|
|  | <ul style="list-style-type: none"> <li>• <b>Application:</b> Zones with oils and lubricants</li> <li>• <b>Connection type head A:</b> Female connector, M23, 12-pin, straight</li> <li>• <b>Connection type head B:</b> Flying leads</li> <li>• <b>Signal type:</b> Incremental</li> <li>• <b>Cable:</b> 20 m, 12-wire, PUR, halogen-free</li> <li>• <b>Description:</b> Incremental, shielded</li> <li>• <b>Application:</b> Zones with oils and lubricants</li> </ul> | DOL-2312-G20MMD1 | 2062246  |
|  | <ul style="list-style-type: none"> <li>• <b>Connection type head A:</b> Female connector, M23, 12-pin, straight</li> <li>• <b>Connection type head B:</b> Flying leads</li> <li>• <b>Signal type:</b> Incremental</li> <li>• <b>Cable:</b> 30 m, 12-wire, PUR, halogen-free</li> <li>• <b>Description:</b> Incremental, shielded</li> <li>• <b>Application:</b> Zones with oils and lubricants</li> </ul>   | DOL-2312-G30MMD1 | 2062247  |
|  | <ul style="list-style-type: none"> <li>• <b>Connection type head A:</b> Female connector, M23, 12-pin, straight, A-coded</li> <li>• <b>Signal type:</b> HIPERFACE<sup>®</sup>, SSI, Incremental</li> <li>• <b>Description:</b> HIPERFACE<sup>®</sup>, shielded, SSI, Incremental</li> <li>• <b>Connection systems:</b> Solder connection</li> </ul>   | DOS-2312-G02     | 2077057  |
|  | <ul style="list-style-type: none"> <li>• <b>Connection type head A:</b> Female connector, M23, 12-pin, angled, A-coded</li> <li>• <b>Signal type:</b> HIPERFACE<sup>®</sup>, SSI, Incremental</li> <li>• <b>Description:</b> HIPERFACE<sup>®</sup>, shielded, SSI, Incremental</li> <li>• <b>Connection systems:</b> Solder connection</li> </ul>   | DOS-2312-W01     | 2072580  |

## SICK AT A GLANCE

SICK is one of the leading manufacturers of intelligent sensors and sensor solutions for industrial applications. A unique range of products and services creates the perfect basis for controlling processes securely and efficiently, protecting individuals from accidents and preventing damage to the environment.

We have extensive experience in a wide range of industries and understand their processes and requirements. With intelligent sensors, we can deliver exactly what our customers need. In application centers in Europe, Asia and North America, system solutions are tested and optimized in accordance with customer specifications. All this makes us a reliable supplier and development partner.

Comprehensive services complete our offering: SICK LifeTime Services provide support throughout the machine life cycle and ensure safety and productivity.

For us, that is “Sensor Intelligence.”

## WORLDWIDE PRESENCE:

Contacts and other locations –[www.sick.com](http://www.sick.com)