



IHM06-04NPOVT0S

IMM

INDUCTIVE PROXIMITY SENSORS

SICK
Sensor Intelligence.



Ordering information

Type	part no.
IHM06-04NPOVT0S	1104505

Other models and accessories → www.sick.com/IMM

Illustration may differ



Detailed technical data

Features

Housing	Cylindrical
Housing	Standard design
Diameter	Ø 6.5 mm
Sensing range S_n	4 mm
Safe sensing range S_a	3.24 mm
Installation type	Non-flush
Switching frequency	3,500 Hz
Connection type	Connector M8, 3-pin
Switching output	PNP
Switching output detail	PNP
Output function	NC
Electrical wiring	DC 3-wire
Enclosure rating	IP67 ¹⁾
Special features	Visual adjustment indicator

¹⁾ According to EN 60529.

Mechanics/electronics

Supply voltage	10 V DC ... 30 V DC
Ripple	≤ 20 % ¹⁾

¹⁾ Of V_S .

²⁾ With $I_a = 200$ mA.

³⁾ Supply voltage U_B and constant ambient temperature T_a .

Voltage drop	$\leq 2 V^{2)}$
Time delay before availability	$\leq 80 \text{ ms}$
Hysteresis	1 % ... 10 %
Reproducibility	$\leq 2 \%^{3)}$
Temperature drift (of S_r)	$\leq 10 \%$
EMC	EN 60947-5-2
Continuous current I_a	$\leq 200 \text{ mA}$
Short-circuit protection	✓
Power-up pulse protection	✓
Shock and vibration resistance	30 g, 11 ms / 10 ... 55 Hz, 1 mm
Ambient operating temperature	-25 °C ... +70 °C
Housing material	Stainless steel V2A, DIN 1.4305 / AISI 303
Sensing face material	Plastic, LCP
Housing length	50 mm
UL File No.	NRKH.E348498

1) Of V_S .

2) With $I_a = 200 \text{ mA}$.

3) Supply voltage U_B and constant ambient temperature T_a .

Safety-related parameters

MTTF_D	1,330 years
DC_{avg}	0 %

Reduction factors

Note	The values are reference values which may vary
St37 steel (Fe)	1
Stainless steel (V2A, 304)	Approx. 0.75
Aluminum (Al)	Approx. 0.5
Copper (Cu)	Approx. 0.43
Brass (Br)	Approx. 0.54

Installation note

Remark	Associated graphic see "Installation"
A	6.5 mm
B	18 mm
C	6.5 mm
D	12 mm
E	8 mm
F	32 mm

Classifications

ECLASS 5.0	27270101
ECLASS 5.1.4	27270101
ECLASS 6.0	27270101

ECLASS 6.2	27270101
ECLASS 7.0	27270101
ECLASS 8.0	27270101
ECLASS 8.1	27270101
ECLASS 9.0	27270101
ECLASS 10.0	27270101
ECLASS 11.0	27270101
ECLASS 12.0	27274001
ETIM 5.0	EC002714
ETIM 6.0	EC002714
ETIM 7.0	EC002714
ETIM 8.0	EC002714
UNSPSC 16.0901	39122230

Certificates

EU declaration of conformity	✓
UK declaration of conformity	✓
ACMA declaration of conformity	✓
Moroccan declaration of conformity	✓
China RoHS	✓
cULus certificate	✓
IO-Link certificate	✓
Information according to Art. 3 of Data Act (Regulation EU 2023/2854)	✓

Installation note Mounting using BEF-KH-M06 bracket

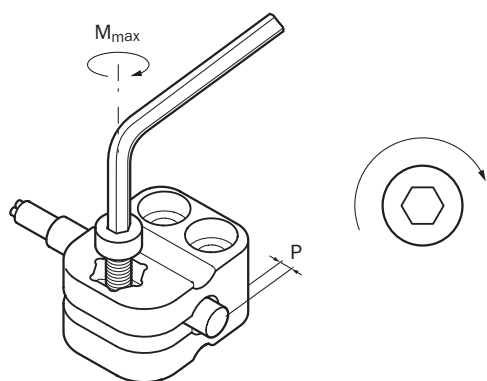

Sensor type	Mounting adapter	Overrun (P)	Max. tightening torque (M_{max})
IHM06-04N***** IHM06-06N*****	BEF-KH-M06, part no. 2101067	≥ 4 mm	≤ 0.6 Nm

Installation note Fixing with setscrew

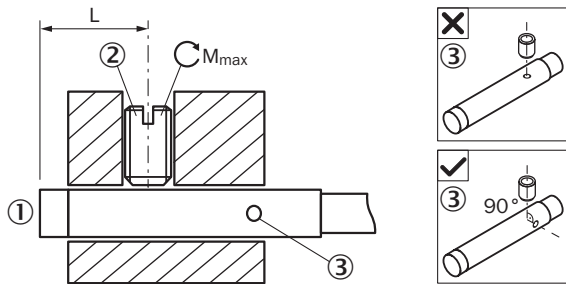

- ① Sensing face
- ② Recommended setscrew: M3, flat point
- ③ Display LED

Sensor type	Mounting area (L)	Max. tightening torque (M_{max})
IHM06-04N****K	8 mm ... 21 mm	≤ 0.4 Nm
IHM06-04N***TOK	8 mm ... 32 mm	≤ 0.4 Nm
IHM06-04N****S	8 mm ... 32 mm	≤ 0.4 Nm
IHM06-04N***TOS	8 mm ... 42 mm	≤ 0.4 Nm
IHM06-06N****K	12 mm ... 21 mm	≤ 0.4 Nm
IHM06-06N***TOK	12 mm ... 32 mm	≤ 0.4 Nm
IHM06-06N****S	12 mm ... 32 mm	≤ 0.4 Nm
IHM06-06N***TOS	12 mm ... 42 mm	≤ 0.4 Nm

Installation note Non-flush installation

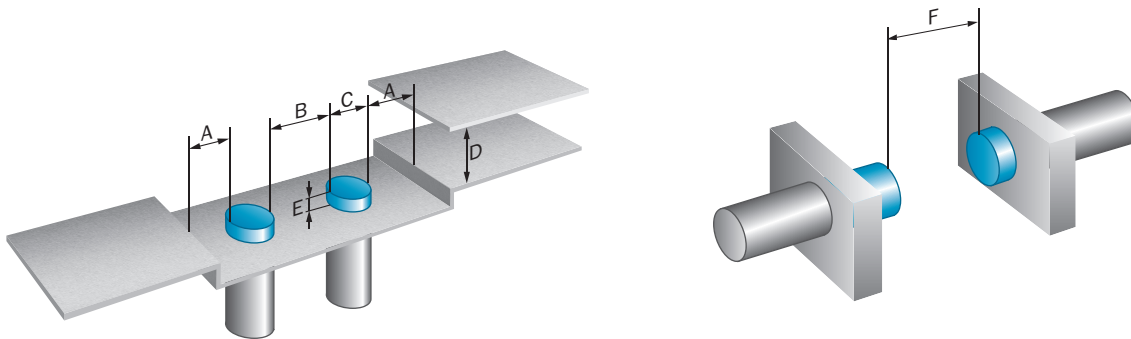

Connection diagram Cd-004

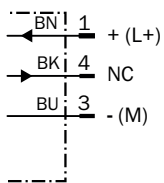

Response diagram

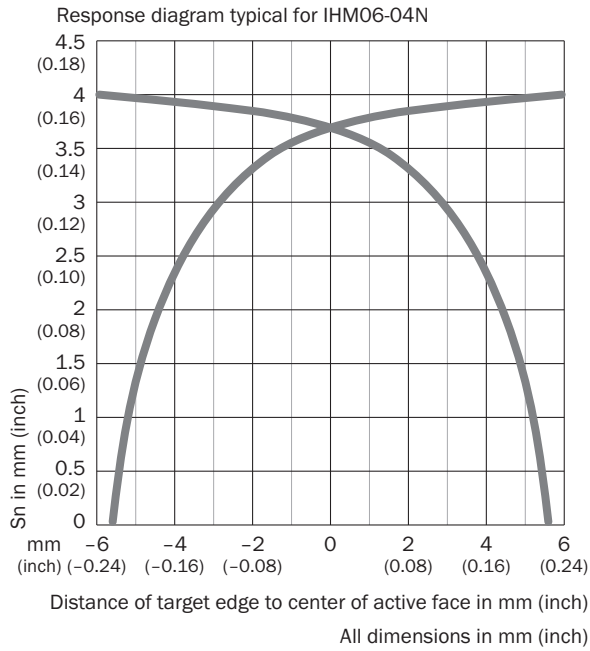

Functional principle Installation aid

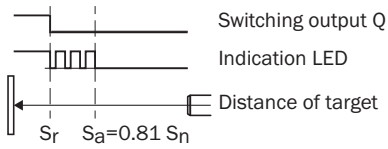

Dimensional drawing IHM06, standard variant, non-flush, male connector

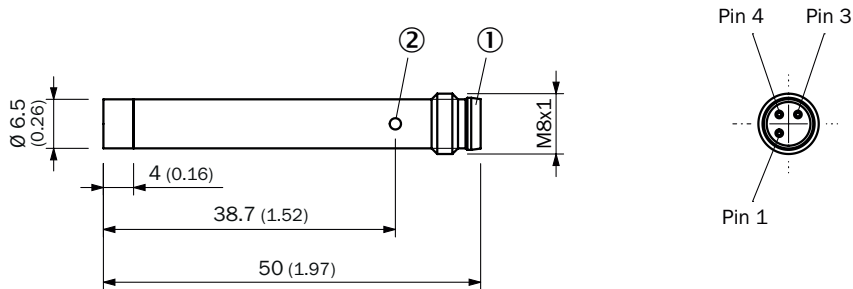

Dimensions in mm (inch)





- ① Connection
- ② function indicator



Recommended accessories

Other models and accessories → www.sick.com/IMM

	Brief description	Type	part no.
Mounting systems			
	<ul style="list-style-type: none"> • Material: Plastic • Details: Plastic (PA6) • Items supplied: Without mounting hardware • Usable for: Round sensors with 6.5 mm housing diameter without fixed stop 	BEF-KH-M06	2101067

	Brief description	Type	part no.
connectors and cables			
	<ul style="list-style-type: none"> • Number of slots: 4 • Slot connection type: M8, 3-pin, A-coded, female connector • Items supplied: 5 x labeling plates • Description: Unshielded 	Y8A34A2-C2A8000XXX	2115733
	<ul style="list-style-type: none"> • Number of slots: 4 • Slot connection type: M8, 3-pin, A-coded, female connector • Items supplied: 5 x labeling plates • Cable: 5 m, 6-wire, PUR, halogen-free • Description: Unshielded • Application: Drag chain operation 	Y8A34A2-LXXXUAA050	2115727
	<ul style="list-style-type: none"> • Number of slots: 6 • Slot connection type: M8, 3-pin, A-coded, female connector • Items supplied: 5 x labeling plates • Description: Unshielded 	Y8A36A2-C2A8000XXX	2115734
	<ul style="list-style-type: none"> • Number of slots: 6 • Slot connection type: M8, 3-pin, A-coded, female connector • Items supplied: 5 x labeling plates • Cable: 5 m, 8-wire, PUR, halogen-free • Description: Unshielded • Application: Drag chain operation 	Y8A36A2-LXXXUBA050	2115728
	<ul style="list-style-type: none"> • Connection type head A: Female connector, M8, 3-pin, straight, A-coded • Connection type head B: Flying leads • Signal type: Sensor/actuator cable • Cable: 2 m, 3-wire, PUR, halogen-free • Description: Sensor/actuator cable, unshielded • Application: Drag chain operation, Zones with oils and lubricants, Robot, Drag chain operation 	YF8U13-020UA1XLEAX	2094782
	<ul style="list-style-type: none"> • Connection type head A: Female connector, M8, 3-pin, straight, A-coded • Connection type head B: Flying leads • Signal type: Sensor/actuator cable • Cable: 5 m, 3-wire, PUR, halogen-free • Description: Sensor/actuator cable, unshielded • Application: Drag chain operation, Zones with oils and lubricants, Robot, Drag chain operation 	YF8U13-050UA1XLEAX	2094788
	<ul style="list-style-type: none"> • Connection type head A: Female connector, M8, 3-pin, straight, A-coded • Connection type head B: Flying leads • Signal type: Sensor/actuator cable • Cable: 2 m, 3-wire, PVC • Description: Sensor/actuator cable, unshielded • Application: Uncontaminated zones, Zones with chemicals 	YF8U13-020VA1XLEAX	2095860
	<ul style="list-style-type: none"> • Connection type head A: Female connector, M8, 3-pin, straight, A-coded • Connection type head B: Flying leads • Signal type: Sensor/actuator cable • Cable: 5 m, 3-wire, PVC • Description: Sensor/actuator cable, unshielded • Application: Uncontaminated zones, Zones with chemicals 	YF8U13-050VA1XLEAX	2095884
	<ul style="list-style-type: none"> • Connection type head A: Female connector, M8, 3-pin, angled, A-coded • Connection type head B: Flying leads • Signal type: Sensor/actuator cable • Cable: 2 m, 3-wire, PUR, halogen-free • Description: Sensor/actuator cable, unshielded • Application: Drag chain operation, Zones with oils and lubricants, Robot, Drag chain operation 	YG8U13-020UA1XLEAX	2094794
	<ul style="list-style-type: none"> • Connection type head A: Female connector, M8, 3-pin, angled, A-coded • Connection type head B: Flying leads • Signal type: Sensor/actuator cable • Cable: 5 m, 3-wire, PUR, halogen-free • Description: Sensor/actuator cable, unshielded • Application: Drag chain operation, Zones with oils and lubricants, Robot, Drag chain operation 	YG8U13-050UA1XLEAX	2095586
	<ul style="list-style-type: none"> • Connection type head A: Female connector, M8, 3-pin, angled, A-coded • Connection type head B: Flying leads • Signal type: Sensor/actuator cable • Cable: 2 m, 3-wire, PVC • Description: Sensor/actuator cable, unshielded 	YG8U13-020VA1XLEAX	2096165

	Brief description	Type	part no.
	<ul style="list-style-type: none"> Application: Uncontaminated zones, Zones with chemicals Connection type head A: Female connector, M8, 3-pin, angled, A-coded Connection type head B: Flying leads Signal type: Sensor/actuator cable Cable: 5 m, 3-wire, PVC Description: Sensor/actuator cable, unshielded Application: Uncontaminated zones, Zones with chemicals 	YG8U13-050VA1XLEAX	2096166
	<ul style="list-style-type: none"> Connection type head A: Female connector, M8, 3-pin, straight, A-coded Connection type head B: Male connector, M12, 3-pin, straight, A-coded Signal type: Sensor/actuator cable Cable: 2 m, 3-wire, PUR, halogen-free Description: Sensor/actuator cable, unshielded Application: Drag chain operation, Zones with oils and lubricants, Robot, Drag chain operation 	YF8U13-020UA1M2A13	2096169
	<ul style="list-style-type: none"> Connection type head A: Female connector, M8, 3-pin, straight, A-coded Connection type head B: Male connector, M12, 3-pin, straight, A-coded Signal type: Sensor/actuator cable Cable: 5 m, 3-wire, PUR, halogen-free Description: Sensor/actuator cable, unshielded Application: Drag chain operation, Zones with oils and lubricants, Robot, Drag chain operation 	YF8U13-050UA1M2A13	2096170
	<ul style="list-style-type: none"> Connection type head A: Female connector, M8, 3-pin, straight, A-coded Connection type head B: Male connector, M12, 3-pin, straight, A-coded Signal type: Sensor/actuator cable Cable: 2 m, 3-wire, PVC Description: Sensor/actuator cable, unshielded Application: Uncontaminated zones, Zones with chemicals 	YF8U13-020VA1M2A13	2096605
	<ul style="list-style-type: none"> Connection type head A: Female connector, M8, 3-pin, straight, A-coded Connection type head B: Male connector, M12, 3-pin, straight, A-coded Signal type: Sensor/actuator cable Cable: 5 m, 3-wire, PVC Description: Sensor/actuator cable, unshielded Application: Uncontaminated zones, Zones with chemicals 	YF8U13-050VA1M2A13	2096606
	<ul style="list-style-type: none"> Connection type head A: Female connector, M8, 3-pin, angled, A-coded Connection type head B: Male connector, M12, 3-pin, straight, A-coded Signal type: Sensor/actuator cable Cable: 2 m, 3-wire, PUR, halogen-free Description: Sensor/actuator cable, unshielded Application: Drag chain operation, Zones with oils and lubricants, Robot, Drag chain operation 	YG8U13-020UA1M2A13	2095748
	<ul style="list-style-type: none"> Connection type head A: Female connector, M8, 3-pin, straight, A-coded Connection type head B: Male connector, M8, 3-pin, straight, A-coded Signal type: Sensor/actuator cable Cable: 2 m, 3-wire, PUR, halogen-free Description: Sensor/actuator cable, unshielded Application: Drag chain operation, Zones with oils and lubricants, Robot, Drag chain operation 	YF8U13-020UA1M8U13	2096304
	<ul style="list-style-type: none"> Connection type head A: Female connector, M8, 3-pin, straight, A-coded Connection type head B: Male connector, M8, 3-pin, straight, A-coded Signal type: Sensor/actuator cable Cable: 5 m, 3-wire, PUR, halogen-free Description: Sensor/actuator cable, unshielded Application: Drag chain operation, Zones with oils and lubricants, Robot, Drag chain operation 	YF8U13-050UA1M8U13	2096308
	<ul style="list-style-type: none"> Connection type head A: Female connector, M8, 3-pin, angled, A-coded Connection type head B: Male connector, M8, 3-pin, straight, A-coded Signal type: Sensor/actuator cable Cable: 2 m, 3-wire, PUR, halogen-free Description: Sensor/actuator cable, unshielded Application: Drag chain operation, Zones with oils and lubricants, Robot, Drag chain operation 	YG8U13-020UA1M8U13	2107781
	<ul style="list-style-type: none"> Connection type head A: Female connector, M8, 3-pin, angled, A-coded Connection type head B: Male connector, M12, 3-pin, straight, A-coded Signal type: Sensor/actuator cable Cable: 5 m, 3-wire, PUR, halogen-free Description: Sensor/actuator cable, unshielded Application: Drag chain operation, Zones with oils and lubricants, Robot, Drag chain operation 	YG8U13-050UA1M2A13	2122842
	<ul style="list-style-type: none"> Connection type head A: Female connector, M8, 3-pin, straight, A-coded Connection type head B: Male connector, M12, 3-pin, straight, A-coded Signal type: Sensor/actuator cable Cable: 3 m, 3-wire, PUR, halogen-free Description: Sensor/actuator cable, unshielded 	YF8U13-030UA1M2A13	2144589

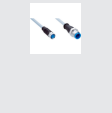
	Brief description	Type	part no.
	<ul style="list-style-type: none"> Application: Drag chain operation, Zones with oils and lubricants, Robot, Drag chain operation Connection type head A: Female connector, M8, 3-pin, angled, A-coded Connection type head B: Flying leads Signal type: Sensor/actuator cable Cable: 0.6 m, 3-wire, PUR, halogen-free Description: Sensor/actuator cable, unshielded Application: Drag chain operation, Zones with oils and lubricants, Robot, Drag chain operation 	YG8U13-C60UA1XLEAX	2145889
	<ul style="list-style-type: none"> Connection type head A: Female connector, M8, 3-pin, angled, A-coded Connection type head B: Flying leads Signal type: Sensor/actuator cable Cable: 3 m, 3-wire, PUR, halogen-free Description: Sensor/actuator cable, unshielded Application: Drag chain operation, Zones with oils and lubricants, Robot, Drag chain operation 	YG8U13-030UA1XLEAX	2145891
	<ul style="list-style-type: none"> Connection type head A: Female connector, M8, 3-pin, straight, A-coded Connection type head B: Flying leads Signal type: Sensor/actuator cable Cable: 0.6 m, 3-wire, PVC Description: Sensor/actuator cable, unshielded Application: Uncontaminated zones, Zones with chemicals 	YF8U13-C60VA1XLEAX	2146368
	<ul style="list-style-type: none"> Connection type head A: Female connector, M8, 3-pin, straight, A-coded Connection type head B: Male connector, M12, 3-pin, straight, A-coded Signal type: Sensor/actuator cable Cable: 1 m, 3-wire, PVC Description: Sensor/actuator cable, unshielded Application: Uncontaminated zones, Zones with chemicals 	YF8U13-010VA1M2A13	2146381

SICK AT A GLANCE

SICK is one of the leading manufacturers of intelligent sensors and sensor solutions for industrial applications. A unique range of products and services creates the perfect basis for controlling processes securely and efficiently, protecting individuals from accidents and preventing damage to the environment.

We have extensive experience in a wide range of industries and understand their processes and requirements. With intelligent sensors, we can deliver exactly what our customers need. In application centers in Europe, Asia and North America, system solutions are tested and optimized in accordance with customer specifications. All this makes us a reliable supplier and development partner.

Comprehensive services complete our offering: SICK LifeTime Services provide support throughout the machine life cycle and ensure safety and productivity.

For us, that is “Sensor Intelligence.”

WORLDWIDE PRESENCE:

Contacts and other locations –www.sick.com