



NANS3-CAAZ30AN1

nanoScan3

SAFETY LASER SCANNERS

SICK
Sensor Intelligence.



Illustration may differ



Ordering information

Type	part no.
NANS3-CAAZ30AN1	1100334

Other models and accessories → www.sick.com/nanoScan3

Detailed technical data

Features

Product version	nanoScan3 Pro I/O
Model	Sensor without system plug
Application	Indoor
Protective field range	3 m
Warning field range	10 m
Distance measuring range	40 m
Number of simultaneously monitored fields	≤ 8 ^{1) 2)}
Number of fields	128
Number of monitoring cases	128
Scanning angle	275°
Resolution (can be configured)	20 mm 30 mm 40 mm 50 mm 60 mm 70 mm 150 mm 200 mm
Angular resolution	0.17°
Response time	70 ms
Protective field supplement	65 mm

¹⁾ Protection, warning or contour detection fields.

²⁾ Please note the number of available OSSD pairs.

Safety-related parameters

Type	Type 3 (IEC 61496)
Safety integrity level	SIL 2 (IEC 61508)

Category	Category 3 (EN ISO 13849)
Performance level	PL d (EN ISO 13849)
PFH_D (mean probability of a dangerous failure per hour)	8.0 x 10 ⁻⁸
T_M (mission time)	20 years (EN ISO 13849)
Safe state in the event of a fault	At least one OSSD is in the OFF state.

Functions

Restart interlock	✓
External device monitoring (EDM)	✓
Multiple sampling	✓
Monitoring case switching	✓
Simultaneous monitoring	✓
Static protective field switching	✓
Dynamic protective field switching	✓
Safe contour detection	✓
Contour as a reference	✓
Integrated configuration memory	✓
Measured data output	Via Ethernet

Interfaces

Connection type	Depending on system plug
Universal I/Os	4 ¹⁾
Outputs	
OSSD pairs	2 ²⁾
Inputs	
Universal inputs	8 ³⁾
Dynamic switching signals	4 ²⁾
Static control inputs	6 ²⁾
Configuration method	PC with Safety Designer (Configuration and Diagnostic Software)
Configuration and diagnostics interface	USB 2.0, micro USB
Data interface	
Services	CoLa 2 (configuration and diagnostics using Safety Designer)
	Data output
	DHCP
	SNTIP
Display elements	Graphic color display, LEDs

¹⁾ Freely programmable as input or output, e.g. external device monitoring input, reset input, static control input, contamination warning, warning field, reset required.

²⁾ Availability depends on the configuration of the universal I/Os and universal inputs.

³⁾ Freely programmable input, e.g. external device monitoring input, reset input, static control input.

Electronics

Protection class	III (EN 61140)
Supply voltage V_s	24 V DC (16.8 V DC ... 30 V DC)

Power consumption typical	3.9 W (without output load)
----------------------------------	-----------------------------

Mechanics

Dimensions (W x H x D)	106.6 mm x 80 mm x 117.5 mm (including system plug)
Weight	0.67 kg
Housing material	Aluminum
Housing color	RAL 1021 (yellow), RAL 9005 (black)
Optics cover material	Polycarbonate

Ambient data

Enclosure rating	IP65 (IEC 60529)
Ambient light immunity	≤ 40 klx (IEC 61496-3) ¹⁾
Ambient operating temperature	-10 °C ... +50 °C
Storage temperature	-25 °C ... +70 °C
Vibration resistance	IEC 60068-2-6, IEC 60068-2-64, IEC 60721-3-5, IEC TR 60721-4-5, IEC 61496-3
Shock resistance	IEC 60068-2-27, IEC 60721-3-5, IEC TR 60721-4-5, IEC 61496-3
Class	5M1 (IEC 60721-3-5)
Class	5M1 (IEC 60721-3-5)
Continuous shock	50 m/s ² , 11 ms
	100 m/s ² , 16 ms
EMC	IEC 61496-1, IEC 61000-6-2, IEC 61000-6-3

¹⁾ Typical ambient light immunity, for ambient light sources directly in the scan plane in accordance with IEC 61496-3: ≤ 3 klx.

Other information

Type of light	Pulsed laser diode
Wave length	905 nm
Detectable remission factor	1.8% to several 1000%
Laser class	1 (21 CFR 1040.10 and 1040.11, IEC 60825-1)

Certificates

EU declaration of conformity	✓
UK declaration of conformity	✓
ACMA declaration of conformity	✓
China RoHS	✓
UK-Type-Examination approval	✓
cULus certificate	✓
S Mark certificate	✓
EC-Type-Examination approval	✓
China GB certificate	✓
Information according to Art. 3 of Data Act (Regulation EU 2023/2854)	✓

Classifications

ECLASS 5.0	27272705
ECLASS 5.1.4	27272705

ECLASS 6.0	27272705
ECLASS 6.2	27272705
ECLASS 7.0	27272705
ECLASS 8.0	27272705
ECLASS 8.1	27272705
ECLASS 9.0	27272705
ECLASS 10.0	27272705
ECLASS 11.0	27272705
ECLASS 12.0	27272705
ETIM 5.0	EC002550
ETIM 6.0	EC002550
ETIM 7.0	EC002550
ETIM 8.0	EC002550
UNSPSC 16.0901	39121528

Dimensional drawing

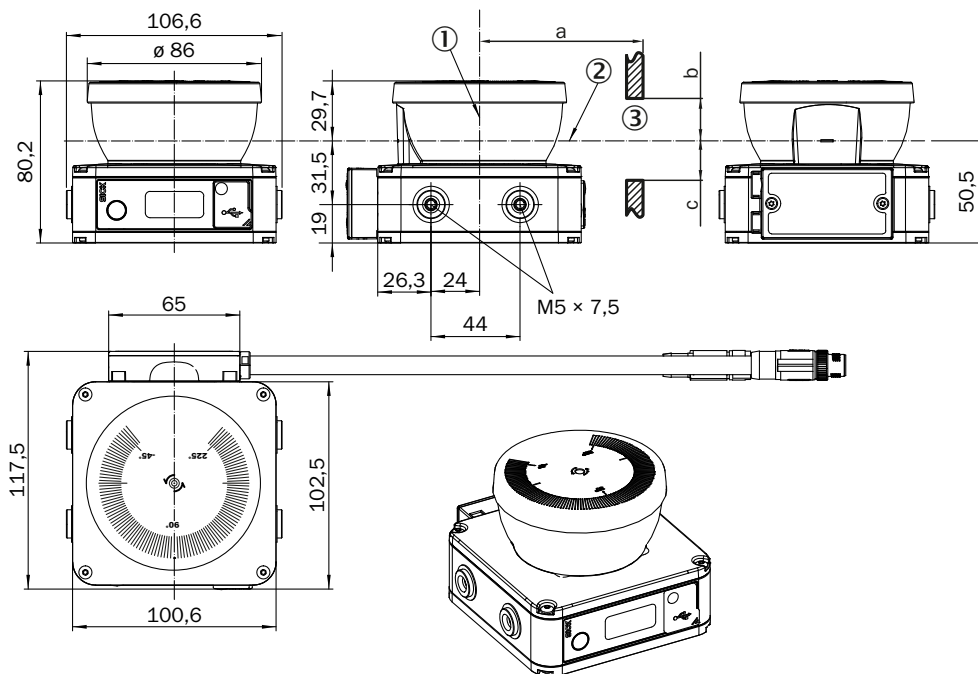

Dimensions in mm (inch)









① mirror axis of rotation

② scan plane

③ required viewing slit (a: length of the viewing slit, b: minimum height above the scan plane, c: minimum height below the scan plane. See the operating instructions for details.)

Recommended accessories

Other models and accessories → www.sick.com/nanoScan3

	Brief description	Type	part no.
Mounting systems			
	<ul style="list-style-type: none"> Description: Mounting bracket Material: Stainless steel Details: Stainless steel V2A (1.4301), powder-coated IGP-DURA face 5803A Packing unit: 1 piece 	Mounting kit 1a	2111767
	<ul style="list-style-type: none"> Description: Mounting bracket with optics cover protection Material: Stainless steel Details: Stainless steel V2A (1.4301), powder-coated IGP-DURA face 5803A Packing unit: 1 piece 	Mounting kit 1b	2111768
	<ul style="list-style-type: none"> Description: Alignment bracket, alignment with cross-wise axis and depth axis possible Material: Stainless steel Details: Stainless steel V2A (1.4301), powder-coated IGP-DURA face 5803A Packing unit: 1 piece 	Mounting kit 2a	2111769
	<ul style="list-style-type: none"> Description: Alignment bracket with protection for the optics cover, alignment with cross-wise axis and depth axis possible Material: Stainless steel Details: Stainless steel V2A (1.4301), powder-coated IGP-DURA face 5803A Packing unit: 1 piece 	Mounting kit 2b	2111770
system plugs and extension modules			
	<ul style="list-style-type: none"> Description: Integrated configuration memory 	NANSX-AAACAEZZ1	2104860
	<ul style="list-style-type: none"> Description: Integrated configuration memory 	NANSX-AAACZZZZ1	2105107
	<ul style="list-style-type: none"> Description: Integrated configuration memory 	NANSX-AACCZZZZ1	2105109
	<ul style="list-style-type: none"> Description: Integrated configuration memory 	NANSX-AACCAEZZ1	2105108

SICK AT A GLANCE

SICK is one of the leading manufacturers of intelligent sensors and sensor solutions for industrial applications. A unique range of products and services creates the perfect basis for controlling processes securely and efficiently, protecting individuals from accidents and preventing damage to the environment.

We have extensive experience in a wide range of industries and understand their processes and requirements. With intelligent sensors, we can deliver exactly what our customers need. In application centers in Europe, Asia and North America, system solutions are tested and optimized in accordance with customer specifications. All this makes us a reliable supplier and development partner.

Comprehensive services complete our offering: SICK LifeTime Services provide support throughout the machine life cycle and ensure safety and productivity.

For us, that is “Sensor Intelligence.”

WORLDWIDE PRESENCE:

Contacts and other locations –www.sick.com