



# DGS34-5LK04096

DGS3x

INCREMENTAL ENCODERS

**SICK**  
Sensor Intelligence.

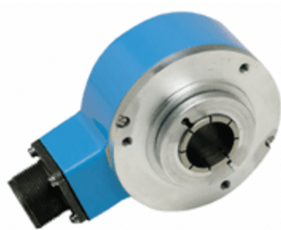

Illustration may differ

### Ordering information

Type	part no.
DGS34-5LK04096	7101765

Other models and accessories → [www.sick.com/DGS3x](http://www.sick.com/DGS3x)

### Detailed technical data

#### Performance

<b>Pulses per revolution</b>	4,096
<b>Measuring step</b>	90° electric/pulses per revolution
<b>Measuring step deviation</b>	± 45° / pulses per revolution
<b>Error limits</b>	± 45° / pulses per revolution

#### Interfaces

<b>Communication interface</b>	Incremental
<b>Communication Interface detail</b>	HTL / Push pull
<b>Output frequency</b>	300 kHz
<b>Load current</b>	40 mA
<b>Operating current</b>	100 mA (without load)

#### Electrical data

<b>Connection type</b>	Cable, 11-wire, radial, 1.5 m
<b>Supply voltage</b>	8 ... 24 V
<b>Reference signal, number</b>	1
<b>Reference signal, position</b>	180°, electronically, gated with B negative
<b>Reverse polarity protection</b>	✓
<b>Short-circuit protection of the outputs</b>	✓

#### Mechanical data

<b>Mechanical design</b>	Blind hollow shaft
<b>Shaft diameter</b>	30 mm <sup>1)</sup>
<b>Flange type / stator coupling</b>	Stator coupling over dowel pin supplied by customer
<b>Weight</b>	1.1 kg <sup>2)</sup>
<b>Shaft material</b>	Brass
<b>Flange material</b>	Aluminum
<b>Housing material</b>	Aluminum
<b>Start up torque</b>	9 Ncm (+20 °C)
<b>Operating torque</b>	7 Ncm (+20 °C)

<sup>1)</sup> Separately order collets for 24 mm and 25 mm as accessories.

<sup>2)</sup> Based on devices with male connector.

<b>Operating speed</b>	3,000 min <sup>-1</sup>
<b>Moment of inertia of the rotor</b>	490 gcm <sup>2</sup>
<b>Bearing lifetime</b>	4.5 x 10 <sup>9</sup> revolutions
<b>Angular acceleration</b>	≤ 100,000 rad/s <sup>2</sup>

<sup>1)</sup> Separately order collets for 24 mm and 25 mm as accessories.

<sup>2)</sup> Based on devices with male connector.

#### Ambient data

<b>EMC</b>	EN 61000-6-2, EN 61000-6-3
<b>Enclosure rating</b>	IP66
<b>Permissible relative humidity</b>	95 % (Condensation not permitted)
<b>Operating temperature range</b>	-20 °C ... +70 °C
<b>Storage temperature range</b>	-30 °C ... +85 °C, without package
<b>Resistance to shocks</b>	50 g, 11 ms
<b>Resistance to vibration</b>	20 g, 5 Hz ... 2,000 Hz

#### Classifications

<b>ECLASS 5.0</b>	27270501
<b>ECLASS 5.1.4</b>	27270501
<b>ECLASS 6.0</b>	27270590
<b>ECLASS 6.2</b>	27270590
<b>ECLASS 7.0</b>	27270501
<b>ECLASS 8.0</b>	27270501
<b>ECLASS 8.1</b>	27270501
<b>ECLASS 9.0</b>	27270501
<b>ECLASS 10.0</b>	27270501
<b>ECLASS 11.0</b>	27270501
<b>ECLASS 12.0</b>	27270501
<b>ETIM 5.0</b>	EC001486
<b>ETIM 6.0</b>	EC001486
<b>ETIM 7.0</b>	EC001486
<b>ETIM 8.0</b>	EC001486
<b>UNSPSC 16.0901</b>	41112113

Dimensional drawing

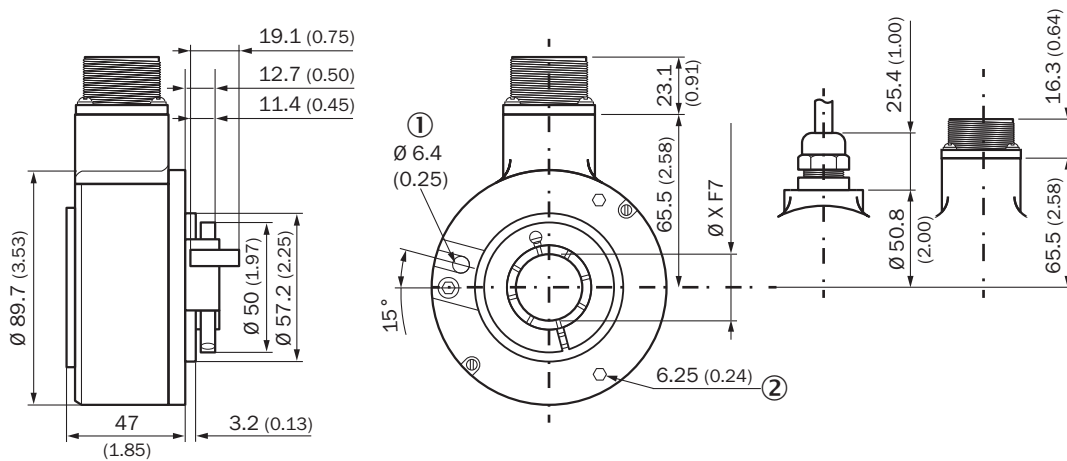

Dimensions in mm (inch)

- ① Dowel pin
- ② depth

Type	Shaft diameter X F7
DGS3x-xxHxxxxx DGS3x-xxJxxxxx	1"
DGS3x-xxKxxxxx DGS3x-xxLxxxxx	30 mm

PIN assignment

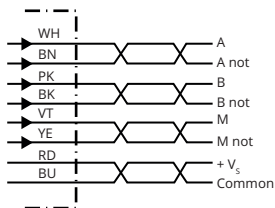

PIN10-pin	Wire colors (cable connection)	Explanation
A	White	A
B	Pink	B
C	Purple	M
H	Brown	A-
I	Black	B-
J	Yellow	M-
D	Red	+V <sub>S</sub>
F	Blue	GND
G	N/A	Earthing point on housing
N/A	N/A	Screen

Diagrams

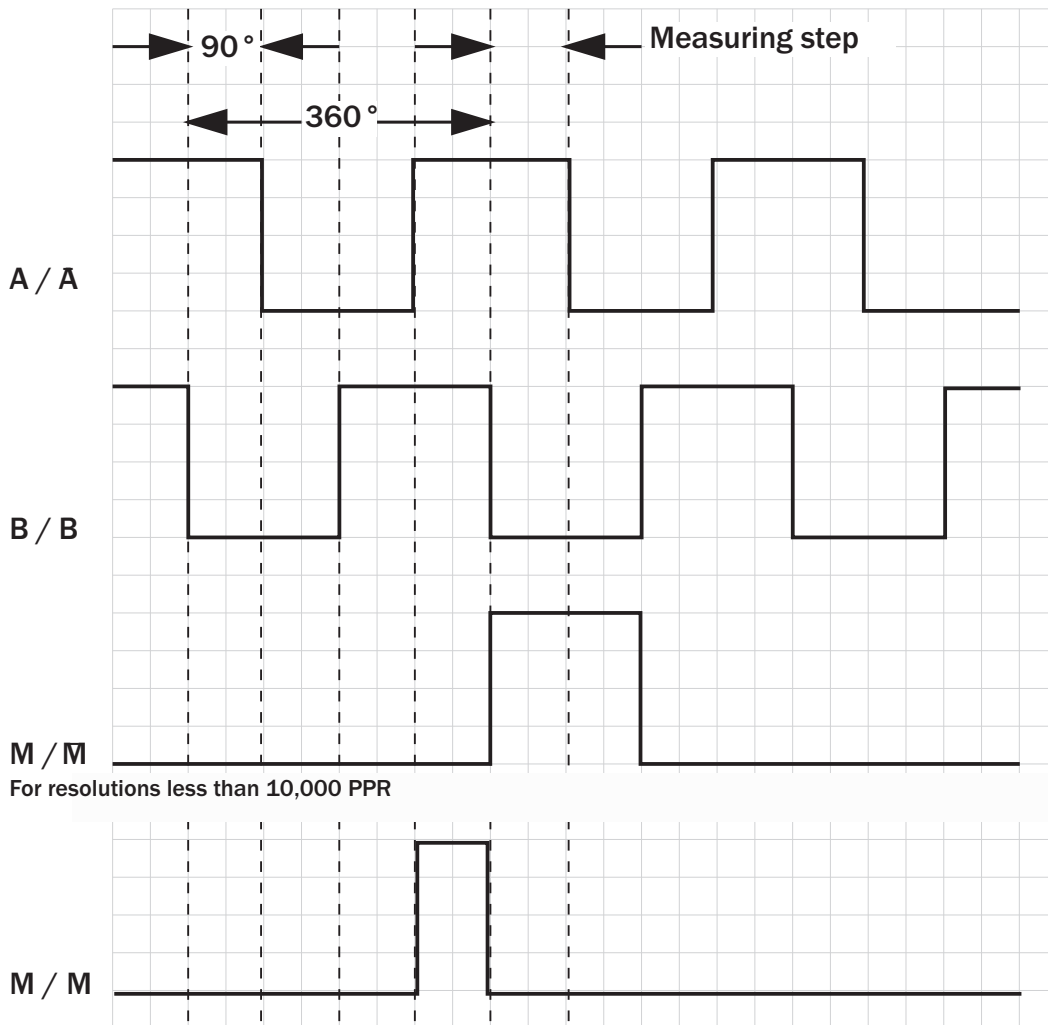

For resolutions less than 10,000 PPR

For resolutions greater than or equal to 10,000 PPR and push-pull driver option

Supply voltage	Output
4,5 V ... 5,5 V	TTL
8 V ... 24 V	TTL
8 V ... 24 V	HTL
8 V ... 24 V	Open Collector
5 V ... 15 V	TTL / HTL

## SICK AT A GLANCE

SICK is one of the leading manufacturers of intelligent sensors and sensor solutions for industrial applications. A unique range of products and services creates the perfect basis for controlling processes securely and efficiently, protecting individuals from accidents and preventing damage to the environment.

We have extensive experience in a wide range of industries and understand their processes and requirements. With intelligent sensors, we can deliver exactly what our customers need. In application centers in Europe, Asia and North America, system solutions are tested and optimized in accordance with customer specifications. All this makes us a reliable supplier and development partner.

Comprehensive services complete our offering: SICK LifeTime Services provide support throughout the machine life cycle and ensure safety and productivity.

For us, that is “Sensor Intelligence.”

## WORLDWIDE PRESENCE:

Contacts and other locations –[www.sick.com](http://www.sick.com)