

DGS34-5H401024

DGS3x

INCREMENTAL ENCODERS

SICK
Sensor Intelligence.

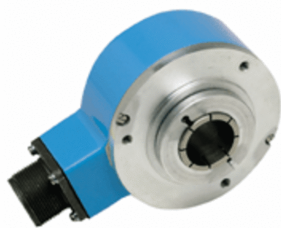

Illustration may differ

Ordering information

Type	part no.
DGS34-5H401024	7101718

Other models and accessories → www.sick.com/DGS3x

Detailed technical data

Performance

Pulses per revolution	1,024
Measuring step	90° electric/pulses per revolution
Measuring step deviation	± 45° / pulses per revolution
Error limits	± 45° / pulses per revolution

Interfaces

Communication interface	Incremental
Communication Interface detail	HTL / Push pull
Output frequency	300 kHz
Load current	40 mA
Operating current	100 mA (without load)

Electrical data

Connection type	Male connector, MS, 10-pin, radial
Supply voltage	8 ... 24 V
Reference signal, number	1
Reference signal, position	180°, electronically, gated with B negative
Reverse polarity protection	✓
Short-circuit protection of the outputs	✓

Mechanical data

Mechanical design	Blind hollow shaft
Shaft diameter	1" ¹⁾
Flange type / stator coupling	T1 stator coupling
Weight	1.1 kg ²⁾
Shaft material	Brass
Flange material	Aluminum
Housing material	Aluminum
Start up torque	9 Ncm (+20 °C)
Operating torque	7 Ncm (+20 °C)

¹⁾ Separately order collets for 1/2", 3/4", 5/8", 7/8", 10 mm, 12 mm, 14 mm, 15 mm, 18 mm, 20 mm, 22 mm, 24 mm and 25 mm as accessories.

²⁾ Based on devices with male connector.

Operating speed	3,000 min ⁻¹
Moment of inertia of the rotor	490 gcm ²
Bearing lifetime	4.5 x 10 ⁹ revolutions
Angular acceleration	≤ 100,000 rad/s ²

¹⁾ Separately order collets for 1/2", 3/4", 5/8", 7/8", 10 mm, 12 mm, 14 mm, 15 mm, 18 mm, 20 mm, 22 mm, 24 mm and 25 mm as accessories.

²⁾ Based on devices with male connector.

Ambient data

EMC	EN 61000-6-2, EN 61000-6-3
Enclosure rating	IP66 ¹⁾
Permissible relative humidity	95 % (Condensation not permitted)
Operating temperature range	-20 °C ... +70 °C
Storage temperature range	-30 °C ... +85 °C, without package
Resistance to shocks	50 g, 11 ms
Resistance to vibration	20 g, 5 Hz ... 2,000 Hz

¹⁾ With mating connector fitted.

Classifications

ECLASS 5.0	27270501
ECLASS 5.1.4	27270501
ECLASS 6.0	27270590
ECLASS 6.2	27270590
ECLASS 7.0	27270501
ECLASS 8.0	27270501
ECLASS 8.1	27270501
ECLASS 9.0	27270501
ECLASS 10.0	27270501
ECLASS 11.0	27270501
ECLASS 12.0	27270501
ETIM 5.0	EC001486
ETIM 6.0	EC001486
ETIM 7.0	EC001486
ETIM 8.0	EC001486
UNSPSC 16.0901	41112113

Dimensional drawing T1 stator coupling

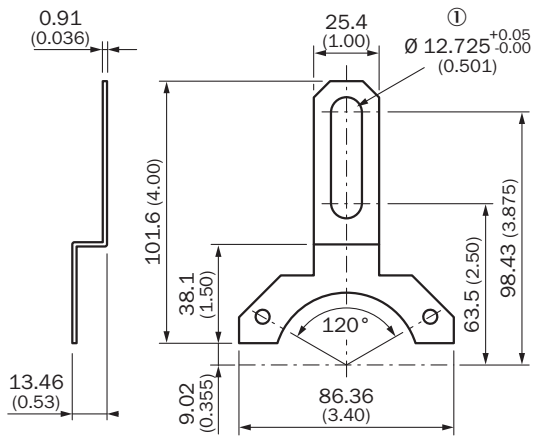

Dimensions in mm (inch)

① T1 slot for screw 3/8"

Dimensional drawing

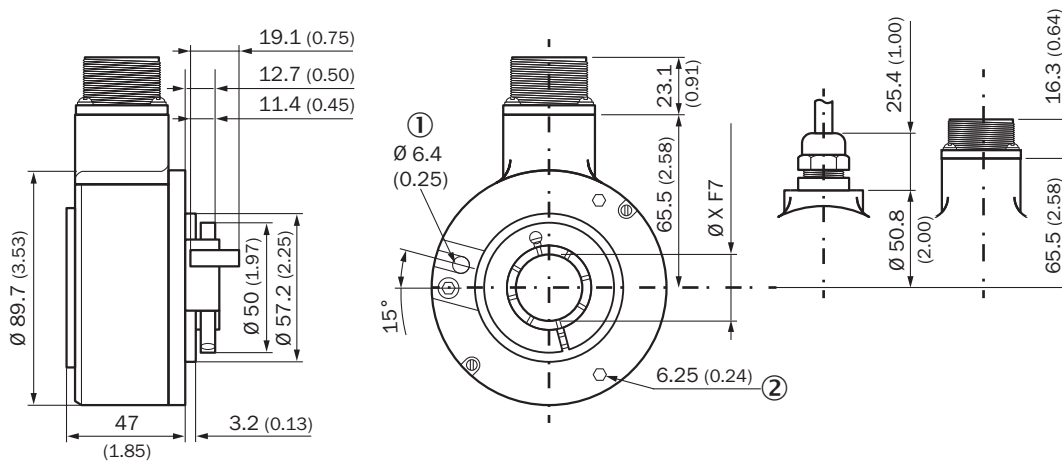

Dimensions in mm (inch)

① Dowel pin

② depth

Type	Shaft diameterX F7
DGS3x-xxHxxxxxx DGS3x-xxJxxxxxx	1"
DGS3x-xxKxxxxxx DGS3x-xxLxxxxxx	30 mm

PIN assignment

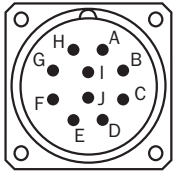

PIN10-pin	Wire colors (cable connection)	Explanation
A	White	A
B	Pink	B
C	Purple	M
H	Brown	A-
I	Black	B-
J	Yellow	M-
D	Red	+V _S
F	Blue	GND
G	N/A	Earthing point on housing
N/A	N/A	Screen

Diagrams

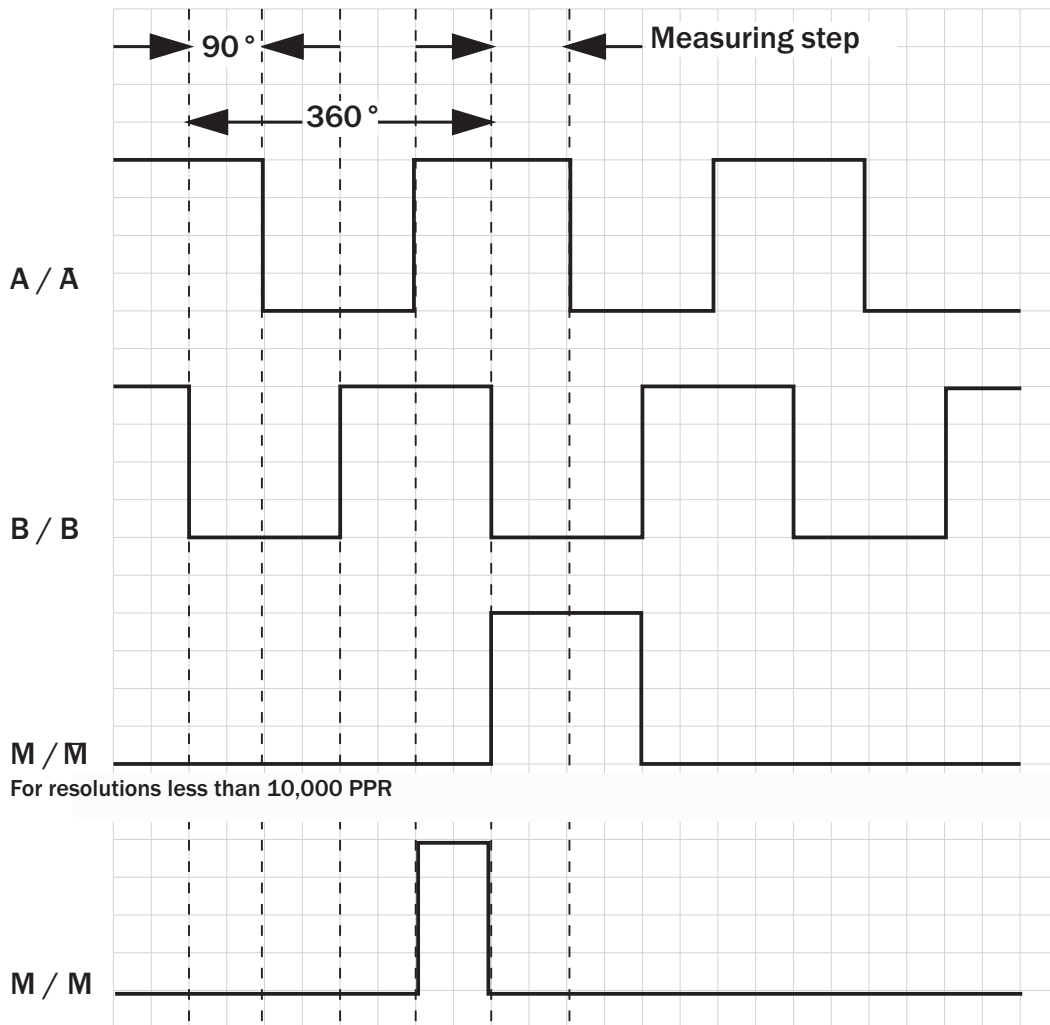

For resolutions less than 10,000 PPR

For resolutions greater than or equal to 10,000 PPR and push-pull driver option

Supply voltage	Output
4,5 V ... 5,5 V	TTL
8 V ... 24 V	TTL
8 V ... 24 V	HTL
8 V ... 24 V	Open Collector
5 V ... 15 V	TTL / HTL

SICK AT A GLANCE

SICK is one of the leading manufacturers of intelligent sensors and sensor solutions for industrial applications. A unique range of products and services creates the perfect basis for controlling processes securely and efficiently, protecting individuals from accidents and preventing damage to the environment.

We have extensive experience in a wide range of industries and understand their processes and requirements. With intelligent sensors, we can deliver exactly what our customers need. In application centers in Europe, Asia and North America, system solutions are tested and optimized in accordance with customer specifications. All this makes us a reliable supplier and development partner.

Comprehensive services complete our offering: SICK LifeTime Services provide support throughout the machine life cycle and ensure safety and productivity.

For us, that is “Sensor Intelligence.”

WORLDWIDE PRESENCE:

Contacts and other locations –www.sick.com