



PFT-2DNLM

PFT-2

PRESSURE SENSORS

SICK
Sensor Intelligence.



Ordering information

Type	part no.
PFT-2DNLM	6087768

Other models and accessories → www.sick.com/PFT-2

Illustration may differ



Detailed technical data

Features

Medium	Liquid, gaseous
Pressure type	Gauge pressure
Pressure unit	bar
Measuring range	0 bar ... 100 bar 0 psi ... 1,450.4 psi
Process temperature	-40 °C ... +100 °C
Maximum ohmic load R_A	4 mA ... 20 mA, 2-wire ($R_A \leq (L^+ - 12 V) / 0.022 A$ [Ohm])
Output signal	4 mA ... 20 mA, 2-wire

Mechanics/electronics

Communication interface	-
Process connection	G ½ external + G ¼ internal (ISO 228-1)
Wetted parts	Process connection: 316L stainless steel
Internal transmission fluid	Silicone oil
Housing material	Stainless steel 316L
Connection type	M12 round connector x 1, 4-pin
Supply voltage	12 V DC ... 35 V DC
Electrical safety	Overvoltage protection: 39 V DC
Dielectric strength	500 V AC
CE-conformity	EMC Directive: 2014/30 / EU, EN 61326-1, EN 61326-2-3:2013 ¹⁾
Weight sensor	Approx. 250 g
Enclosure rating	IP66 ²⁾ IP67
Protection class III	✓

¹⁾ Emission: Class B/Immunity: Industrial Area.

²⁾ Enclosure rating IP per IEC 60529. The enclosure rating classes specified only apply when connected with female connectors that provide the corresponding enclosure rating.

Performance

Accuracy	≤ ± 0.5 %, of the span (DIN EN 60770-1) ¹⁾
Response time (10 % ... 90 %)	Approx. 15 ms
Long-term drift/one-year stability	< 0.15 % Within the nominal measuring range
Temperature coefficient in rated temperature range	< 0.15% / 10 K ²⁾
Rated temperature range	0 °C ... +100 °C
Service life	Minimum 10 Mio. load cycles

¹⁾ Within the nominal measuring range, incl. non-linearity, hysteresis and non-repeatability.

²⁾ In the compensated temperature range -40 °C ... 100 °C (-40 °F ... 212 °F), reference temperature 20 °C (68 °F).

Ambient data

Ambient temperature, operation	-40 °C ... +70 °C -40 °F ... 158 °F
Storage temperature	-40 °C ... +70 °C, with flush-mounted membrane and cooling element -20 °C ... +100 °C -40 °F ... 158 °F
Shock load	Class 6M4 according to IEC 60721-3-6 (50 g, 2.3 ms)
Vibration load	Class 4M8 according to IEC 60271-3-4 (5 g at 4 Hz ... 200 Hz)

Certificates

EU declaration of conformity	✓
UK declaration of conformity	✓
ACMA declaration of conformity	✓
Moroccan declaration of conformity	✓
China RoHS	✓
cULus certificate	✓
RoHS manufacturer declaration	✓

Classifications

ECLASS 5.0	27200614
ECLASS 5.1.4	27200614
ECLASS 6.0	27200614
ECLASS 6.2	27200614
ECLASS 7.0	27200614
ECLASS 8.0	27200614
ECLASS 8.1	27200614
ECLASS 9.0	27200614
ECLASS 10.0	27200614
ECLASS 11.0	27200614
ECLASS 12.0	27200614
ETIM 5.0	EC011478
ETIM 6.0	EC011478
ETIM 7.0	EC011478
ETIM 8.0	EC011478
UNSPSC 16.0901	41112410

Dimensional drawing G ½ external + G ¼ internal (ISO 228-1)

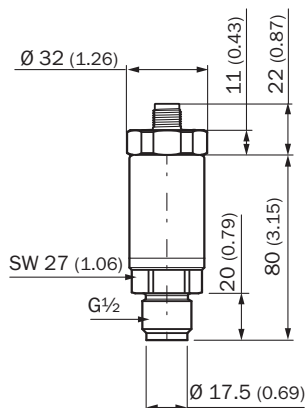

Dimensions in mm (inch)

Dimensional drawing Housing with circular plug-in connector M12 x 1

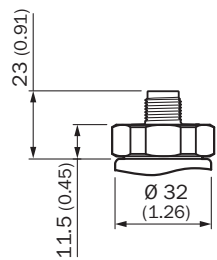

Dimensions in mm (inch)



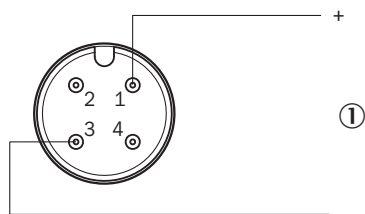

Connection type



Recommended accessories

Other models and accessories → www.sick.com/PFT-2

	Brief description	Type	part no.
connectors and cables			
	<ul style="list-style-type: none"> Connection type head A: Female connector, M12, 4-pin, straight, A-coded Connection type head B: Flying leads Signal type: Sensor/actuator cable Cable: 2 m, 4-wire, PUR, halogen-free Description: Sensor/actuator cable, unshielded Application: Uncontaminated zones, Zones with oils and lubricants, Robot, Drag chain operation 	YF2A14-020UB3XLEAX	2095607
	<ul style="list-style-type: none"> Connection type head A: Female connector, M12, 4-pin, straight, A-coded Connection type head B: Flying leads Signal type: Sensor/actuator cable Cable: 2 m, 4-wire, PVC Description: Sensor/actuator cable, unshielded Application: Zones with chemicals, Uncontaminated zones 	YF2A14-020VB3XLEAX	2096234
	<ul style="list-style-type: none"> Connection type head A: Female connector, M12, 4-pin, straight, A-coded Connection type head B: Flying leads Signal type: Sensor/actuator cable Cable: 5 m, 4-wire, PUR, halogen-free Description: Sensor/actuator cable, unshielded Application: Uncontaminated zones, Zones with oils and lubricants, Robot, Drag chain operation 	YF2A14-050UB3XLEAX	2095608
	<ul style="list-style-type: none"> Connection type head A: Female connector, M12, 4-pin, straight, A-coded Connection type head B: Flying leads Signal type: Sensor/actuator cable Cable: 5 m, 4-wire, PVC Description: Sensor/actuator cable, unshielded Application: Zones with chemicals, Uncontaminated zones 	YF2A14-050VB3XLEAX	2096235
	<ul style="list-style-type: none"> Connection type head A: Female connector, M12, 4-pin, straight, A-coded Connection type head B: Flying leads Signal type: Sensor/actuator cable Cable: 10 m, 4-wire, PUR, halogen-free Description: Sensor/actuator cable, unshielded Application: Uncontaminated zones, Zones with oils and lubricants, Robot, Drag chain operation 	YF2A14-100UB3XLEAX	2095609
	<ul style="list-style-type: none"> Connection type head A: Female connector, M12, 4-pin, straight, A-coded Connection type head B: Flying leads Signal type: Sensor/actuator cable Cable: 10 m, 4-wire, PVC Description: Sensor/actuator cable, unshielded Application: Zones with chemicals, Uncontaminated zones 	YF2A14-100VB3XLEAX	2096236
	<ul style="list-style-type: none"> Connection type head A: Female connector, M12, 4-pin, straight, A-coded Connection type head B: Flying leads Signal type: Sensor/actuator cable Cable: 15 m, 4-wire, PUR, halogen-free Description: Sensor/actuator cable, unshielded Application: Uncontaminated zones, Zones with oils and lubricants, Robot, Drag chain operation 	YF2A14-150UB3XLEAX	2095610
	<ul style="list-style-type: none"> Connection type head A: Female connector, M12, 4-pin, straight, A-coded Connection type head B: Flying leads Signal type: Sensor/actuator cable Cable: 15 m, 4-wire, PVC Description: Sensor/actuator cable, unshielded Application: Zones with chemicals, Uncontaminated zones 	YF2A14-150VB3XLEAX	2096237
	<ul style="list-style-type: none"> Connection type head A: Female connector, M12, 4-pin, straight, A-coded Connection type head B: Flying leads Signal type: Sensor/actuator cable Cable: 20 m, 4-wire, PUR, halogen-free Description: Sensor/actuator cable, unshielded Application: Uncontaminated zones, Zones with oils and lubricants, Robot, Drag chain operation 	YF2A14-200UB3XLEAX	2095611
	<ul style="list-style-type: none"> Connection type head A: Female connector, M12, 4-pin, straight, A-coded Connection type head B: Flying leads Signal type: Sensor/actuator cable Cable: 20 m, 4-wire, PVC Description: Sensor/actuator cable, unshielded 	YF2A14-200VB3XLEAX	2096238

	Brief description	Type	part no.
	<ul style="list-style-type: none"> • Application: Zones with chemicals, Untaminated zones • Connection type head A: Female connector, M12, 4-pin, straight, A-coded • Connection type head B: Flying leads • Signal type: Sensor/actuator cable • Cable: 25 m, 4-wire, PUR, halogen-free • Description: Sensor/actuator cable, unshielded • Application: Untaminated zones, Zones with oils and lubricants, Robot, Drag chain operation 	YF2A14-250UB3XLEAX	2095615
	<ul style="list-style-type: none"> • Connection type head A: Female connector, M12, 4-pin, angled, A-coded • Connection type head B: Flying leads • Signal type: Sensor/actuator cable • Cable: 2 m, 4-wire, PUR, halogen-free • Description: Sensor/actuator cable, unshielded • Application: Untaminated zones, Zones with oils and lubricants, Robot, Drag chain operation 	YG2A14-020UB3XLEAX	2095766
	<ul style="list-style-type: none"> • Connection type head A: Female connector, M12, 4-pin, angled, A-coded • Connection type head B: Flying leads • Signal type: Sensor/actuator cable • Cable: 2 m, 4-wire, PVC • Description: Sensor/actuator cable, unshielded • Application: Zones with chemicals, Untaminated zones 	YG2A14-020VB3XLEAX	2095895
	<ul style="list-style-type: none"> • Connection type head A: Female connector, M12, 4-pin, angled, A-coded • Connection type head B: Flying leads • Signal type: Sensor/actuator cable • Cable: 5 m, 4-wire, PUR, halogen-free • Description: Sensor/actuator cable, unshielded • Application: Untaminated zones, Zones with oils and lubricants, Robot, Drag chain operation 	YG2A14-050UB3XLEAX	2095767
	<ul style="list-style-type: none"> • Connection type head A: Female connector, M12, 4-pin, angled, A-coded • Connection type head B: Flying leads • Signal type: Sensor/actuator cable • Cable: 5 m, 4-wire, PVC • Description: Sensor/actuator cable, unshielded • Application: Zones with chemicals, Untaminated zones 	YG2A14-050VB3XLEAX	2095897
	<ul style="list-style-type: none"> • Connection type head A: Female connector, M12, 4-pin, angled, A-coded • Connection type head B: Flying leads • Signal type: Sensor/actuator cable • Cable: 10 m, 4-wire, PUR, halogen-free • Description: Sensor/actuator cable, unshielded • Application: Untaminated zones, Zones with oils and lubricants, Robot, Drag chain operation 	YG2A14-100UB3XLEAX	2095768
	<ul style="list-style-type: none"> • Connection type head A: Female connector, M12, 4-pin, angled, A-coded • Connection type head B: Flying leads • Signal type: Sensor/actuator cable • Cable: 10 m, 4-wire, PVC • Description: Sensor/actuator cable, unshielded • Application: Zones with chemicals, Untaminated zones 	YG2A14-100VB3XLEAX	2095898
	<ul style="list-style-type: none"> • Connection type head A: Female connector, M12, 4-pin, angled, A-coded • Connection type head B: Flying leads • Signal type: Sensor/actuator cable • Cable: 15 m, 4-wire, PUR, halogen-free • Description: Sensor/actuator cable, unshielded • Application: Untaminated zones, Zones with oils and lubricants, Robot, Drag chain operation 	YG2A14-150UB3XLEAX	2095769
	<ul style="list-style-type: none"> • Connection type head A: Female connector, M12, 4-pin, angled, A-coded • Connection type head B: Flying leads • Signal type: Sensor/actuator cable • Cable: 15 m, 4-wire, PVC • Description: Sensor/actuator cable, unshielded • Application: Zones with chemicals, Untaminated zones 	YG2A14-150VB3XLEAX	2096213
	<ul style="list-style-type: none"> • Connection type head A: Female connector, M12, 4-pin, angled, A-coded • Connection type head B: Flying leads • Signal type: Sensor/actuator cable • Cable: 20 m, 4-wire, PUR, halogen-free • Description: Sensor/actuator cable, unshielded • Application: Untaminated zones, Zones with oils and lubricants, Robot, Drag chain operation 	YG2A14-200UB3XLEAX	2095770
	<ul style="list-style-type: none"> • Connection type head A: Female connector, M12, 4-pin, angled, A-coded • Connection type head B: Flying leads • Signal type: Sensor/actuator cable • Cable: 20 m, 4-wire, PVC • Description: Sensor/actuator cable, unshielded 	YG2A14-200VB3XLEAX	2096214

	Brief description	Type	part no.
	<ul style="list-style-type: none"> • Application: Zones with chemicals, Untaminated zones • Connection type head A: Female connector, M12, 4-pin, angled, A-coded • Connection type head B: Flying leads • Signal type: Sensor/actuator cable • Cable: 25 m, 4-wire, PUR, halogen-free • Description: Sensor/actuator cable, unshielded • Application: Untaminated zones, Zones with oils and lubricants, Robot, Drag chain operation 	YG2A14-250UB3XLEAX	2095771
	<ul style="list-style-type: none"> • Connection type head A: Female connector, M12, 4-pin, straight, A-coded • Connection type head B: Flying leads • Signal type: Sensor/actuator cable • Cable: 0.6 m, 4-wire, PUR, halogen-free • Description: Sensor/actuator cable, unshielded • Application: Untaminated zones, Zones with oils and lubricants, Robot, Drag chain operation 	YF2A14-C60UB3XLEAX	2145654
	<ul style="list-style-type: none"> • Connection type head A: Female connector, M12, 4-pin, straight, A-coded • Connection type head B: Flying leads • Signal type: Sensor/actuator cable • Cable: 1 m, 4-wire, PUR, halogen-free • Description: Sensor/actuator cable, unshielded • Application: Untaminated zones, Zones with oils and lubricants, Robot, Drag chain operation 	YF2A14-010UB3XLEAX	2145655
	<ul style="list-style-type: none"> • Connection type head A: Female connector, M12, 4-pin, straight, A-coded • Connection type head B: Flying leads • Signal type: Sensor/actuator cable • Cable: 3 m, 4-wire, PUR, halogen-free • Description: Sensor/actuator cable, unshielded • Application: Untaminated zones, Zones with oils and lubricants, Robot, Drag chain operation 	YF2A14-030UB3XLEAX	2145656
	<ul style="list-style-type: none"> • Connection type head A: Female connector, M12, 4-pin, angled, A-coded • Connection type head B: Flying leads • Signal type: Sensor/actuator cable • Cable: 0.6 m, 4-wire, PUR, halogen-free • Description: Sensor/actuator cable, unshielded • Application: Untaminated zones, Zones with oils and lubricants, Robot, Drag chain operation 	YG2A14-C60UB3XLEAX	2145657
	<ul style="list-style-type: none"> • Connection type head A: Female connector, M12, 4-pin, angled, A-coded • Connection type head B: Flying leads • Signal type: Sensor/actuator cable • Cable: 1 m, 4-wire, PUR, halogen-free • Description: Sensor/actuator cable, unshielded • Application: Untaminated zones, Zones with oils and lubricants, Robot, Drag chain operation 	YG2A14-010UB3XLEAX	2145658
	<ul style="list-style-type: none"> • Connection type head A: Female connector, M12, 4-pin, angled, A-coded • Connection type head B: Flying leads • Signal type: Sensor/actuator cable • Cable: 0.6 m, 4-wire, PVC • Description: Sensor/actuator cable, unshielded • Application: Zones with chemicals, Untaminated zones 	YG2A14-C60VB3XLEAX	2145709
	<ul style="list-style-type: none"> • Connection type head A: Female connector, M12, 4-pin, angled, A-coded • Connection type head B: Flying leads • Signal type: Sensor/actuator cable • Cable: 1 m, 4-wire, PVC • Description: Sensor/actuator cable, unshielded • Application: Zones with chemicals, Untaminated zones 	YG2A14-010VB3XLEAX	2145710
	<ul style="list-style-type: none"> • Connection type head A: Female connector, M12, 4-pin, straight, A-coded • Connection type head B: Flying leads • Signal type: Sensor/actuator cable • Cable: 0.6 m, 4-wire, PVC • Description: Sensor/actuator cable, unshielded • Application: Zones with chemicals, Untaminated zones 	YF2A14-C60VB3XLEAX	2145707
	<ul style="list-style-type: none"> • Connection type head A: Female connector, M12, 4-pin, straight, A-coded • Connection type head B: Flying leads • Signal type: Sensor/actuator cable • Cable: 1 m, 4-wire, PVC • Description: Sensor/actuator cable, unshielded • Application: Zones with chemicals, Untaminated zones 	YF2A14-010VB3XLEAX	2145708
Mounting systems			
	<ul style="list-style-type: none"> • Description: Weld-in flange/weld-in socket for articles with flush-mounted membrane, process connection G 1/2 B • Material: Stainless steel • Details: Stainless steel 1.4571 	BEF-FL-316G12-BOPH	5322449

SICK AT A GLANCE

SICK is one of the leading manufacturers of intelligent sensors and sensor solutions for industrial applications. A unique range of products and services creates the perfect basis for controlling processes securely and efficiently, protecting individuals from accidents and preventing damage to the environment.

We have extensive experience in a wide range of industries and understand their processes and requirements. With intelligent sensors, we can deliver exactly what our customers need. In application centers in Europe, Asia and North America, system solutions are tested and optimized in accordance with customer specifications. All this makes us a reliable supplier and development partner.

Comprehensive services complete our offering: SICK LifeTime Services provide support throughout the machine life cycle and ensure safety and productivity.

For us, that is “Sensor Intelligence.”

WORLDWIDE PRESENCE:

Contacts and other locations –www.sick.com