



UC40-11211H

UC40

ULTRASONIC DISTANCE SENSORS

SICK
Sensor Intelligence.



Ordering information

Type	part no.
UC40-11211H	6081948

Included in delivery: BEF-KH-IQ40 (1)

Other models and accessories → www.sick.com/UC40



Detailed technical data

Features

Operating range, limiting range	65 mm ... 350 mm, 600 mm
Target	Natural objects
Resolution	≥ 0.1 mm
Repeatability	± 0.15 % ¹⁾
Measurement accuracy	± 1 % ^{2) 3)}
Temperature compensation	✓
Response time	64 ms ⁴⁾
Switching frequency	10 Hz
Output time	16 ms
Ultrasonic frequency (typical)	400 kHz
Detection area (typical)	See diagrams
Additional function	Adjustable operating modes: Switching point (DtO) / Switching window/Background (ObSB), teach-in of digital output, set levels of digital outputs, invertable digital output, set on delay digital output, teach-in of analog output, scaling of analog outputs, Invertable analog output, automatic selection of analog current or voltage output, Analog output switchable to second digital output, synchronization of up to 50 sensors, multiplexing: no cross talk of up to 50 sensors, Adjustable measurement filters: Measured value filters/Filter strength/Foreground suppression/Detection area/Sensitivity and sound beam/False echo suppression, teach-in button(s) (can be deactivated), reset to factory default
Safety-related parameters	
	MTTF _D 101 years
	DC _{avg} 0 %

¹⁾ In relation to the current measured value, minimum value ≥ resolution.

²⁾ Referring to current measurement value.

³⁾ Temperature compensation can be switched off, without temperature compensation: 0.17 % / K.

⁴⁾ Subsequent smoothing of the analog output, depending on the application, may increase the response time by up to 200 %.

Interfaces

IO-Link		✓, IO-Link V1.1
	Function	Process data, parameterization, diagnosis, data storage
Digital output		
	Number	1 ... 2 ¹⁾
	Type	Push-pull: PNP/NPN
	Function	Configurable Q2 output: analog output / digital output
	Maximum output current I_A	≤ 100 mA
Analog output		
	Number	1
	Type	Current output / voltage output
	Function	Automatic selection of analog current or voltage output dependent on load Configurable Q2 output: analog output / digital output
	Current	4 mA ... 20 mA, ≤ 500 Ω ²⁾
	Voltage	0 V ... 10 V, ≥ 100,000 Ω
	Resolution	12 bit
Multifunctional input (MF)		1 x MF
Hysteresis		5 mm

¹⁾ Push-pull: PNP/NPN HIGH = $U_V - (< 3 V)$ / LOW < 3 V.

²⁾ For 4 mA ... 20 mA and $V_S \leq 20 V$ max. load ≤ 100 Ω.

Electronics

Supply voltage U_B	DC 9 V ... 30 V ^{1) 2)}
Power consumption	≤ 1.5 W ³⁾
Initialization time	< 300 ms
Indication	4 x LED
Enclosure rating	IP65 IP67
Protection class	III

¹⁾ Limit values, reverse-polarity protected Operation in short-circuit protected network: max. 8 A, class 2.

²⁾ 15 V ... 30 V when using the analog voltage output.

³⁾ Without load.

Mechanics

Dimensions (W x H x D)	40 mm x 40 mm x 66 mm
Design	Rectangular
Sending axis	Straight ¹⁾
Housing material	Plastic (PA 66, ultrasonic transducer: polyurethane foam, glass epoxy resin)
Weight	120 g
Connection type	Male connector, M12, 5-pin

¹⁾ Sensor head can be rotated 90°, additional 360° incremental alignment via mounting bracket.

Ambient data

Ambient temperature, operation	-25 °C ... +70 °C
---------------------------------------	-------------------

Ambient temperature, storage	-40 °C ... +85 °C
-------------------------------------	-------------------

Certificates

EU declaration of conformity	✓
UK declaration of conformity	✓
ACMA declaration of conformity	✓
Moroccan declaration of conformity	✓
China RoHS	✓
cULus certificate	✓
Information according to Art. 3 of Data Act (Regulation EU 2023/2854)	✓

Classifications

ECLASS 5.0	27270804
ECLASS 5.1.4	27270804
ECLASS 6.0	27270804
ECLASS 6.2	27270804
ECLASS 7.0	27270804
ECLASS 8.0	27270804
ECLASS 8.1	27270804
ECLASS 9.0	27270804
ECLASS 10.0	27270804
ECLASS 11.0	27270804
ECLASS 12.0	27272806
ETIM 5.0	EC001846
ETIM 6.0	EC001846
ETIM 7.0	EC001846
ETIM 8.0	EC001846
UNSPSC 16.0901	41111960

Dimensional drawing UC40-11211x

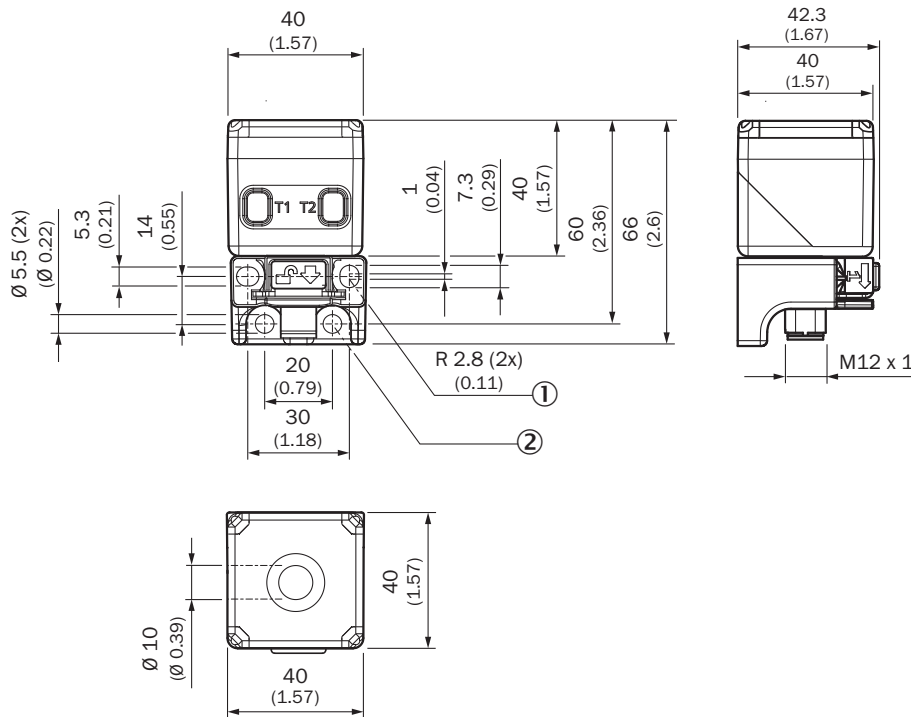

Dimensions in mm (inch)

- ① 2 mounting holes, radius: 2.8 mm
- ② 2 mounting holes, diameter: 5.5 mm

Connection type

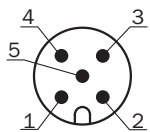

- ① L⁺: Supply voltage, brown
- ② N/C: Not assigned, white
- ③ M: Supply voltage 0 V, blue
- ④ Q/Q̄/C: Digital output, IO-Link communication, black
- ⑤ MF: Multifunction input, synchronization and multiplex operation, communication via Connect+ software, gray

Connection diagram

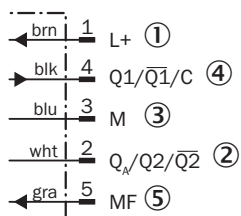

- ① Supply voltage
- ② Analog output or digital output 2

- ③ Supply voltage: 0 V
- ④ Digital output 1, IO-Link communication
- ⑤ Multifunction input (MF), synchronization and multiplex operation, communication via Connect+ software



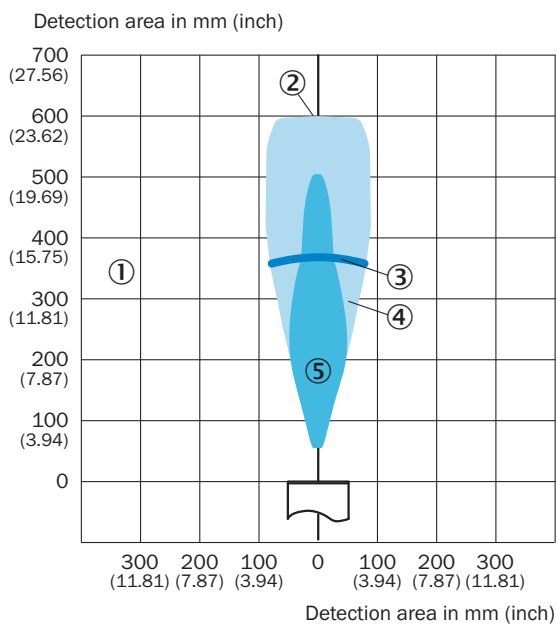



Detection area



- ① Detection range dependent on reflection properties, size, and alignment of the object
- ② Limiting range
- ③ operating range
- ④ example object: aligned plate 500 mm x 500 mm
- ⑤ example object: pipe with 27 mm diameter

Recommended accessories

Other models and accessories → www.sick.com/UC40

	Brief description	Type	part no.
connectors and cables			
	<ul style="list-style-type: none"> Description: Sensor/actuator cable, unshielded Connection type head A: Female connector, M12, 5-pin, straight, A-coded Connection type head B: Flying leads Signal type: Sensor/actuator cable Cable: 2 m, 5-wire, PVC Application: Uncontaminated zones, Zones with chemicals 	YF2A15-020VB5XLEAX	2096239
	<ul style="list-style-type: none"> Description: Sensor/actuator cable, unshielded Connection type head A: Female connector, M12, 5-pin, straight, A-coded Connection type head B: Flying leads Signal type: Sensor/actuator cable Cable: 0.6 m, 5-wire, PVC Application: Uncontaminated zones, Zones with chemicals 	YF2A15-C60VB5XLEAX	2145570
	<ul style="list-style-type: none"> Description: Sensor/actuator cable, unshielded Connection type head A: Female connector, M12, 5-pin, straight, A-coded Connection type head B: Flying leads Signal type: Sensor/actuator cable Cable: 3 m, 5-wire, PVC Application: Uncontaminated zones, Zones with chemicals 	YF2A15-030VB5XLEAX	2145572
network devices			
		SIG100-0A0111100	1089792
		SIG200-0A041220S01	1100615
		IOLA2US-01101 (SiLink2 Master)	1061790

SICK AT A GLANCE

SICK is one of the leading manufacturers of intelligent sensors and sensor solutions for industrial applications. A unique range of products and services creates the perfect basis for controlling processes securely and efficiently, protecting individuals from accidents and preventing damage to the environment.

We have extensive experience in a wide range of industries and understand their processes and requirements. With intelligent sensors, we can deliver exactly what our customers need. In application centers in Europe, Asia and North America, system solutions are tested and optimized in accordance with customer specifications. All this makes us a reliable supplier and development partner.

Comprehensive services complete our offering: SICK LifeTime Services provide support throughout the machine life cycle and ensure safety and productivity.

For us, that is “Sensor Intelligence.”

WORLDWIDE PRESENCE:

Contacts and other locations –www.sick.com