



# UC40-11411B

UC40

ULTRASONIC DISTANCE SENSORS

**SICK**  
Sensor Intelligence.



## Ordering information

Type	part no.
UC40-11411B	6081947

Included in delivery: BEF-KH-IQ40 (1)

Other models and accessories → [www.sick.com/UC40](http://www.sick.com/UC40)



## Detailed technical data

### Features

<b>Operating range, limiting range</b>	350 mm ... 3,400 mm, 5,000 mm
<b>Target</b>	Natural objects
<b>Resolution</b>	≥ 1 mm
<b>Repeatability</b>	± 0.15 % <sup>1)</sup>
<b>Measurement accuracy</b>	± 1 % <sup>2) 3)</sup>
<b>Temperature compensation</b>	✓
<b>Response time</b>	160 ms <sup>4)</sup>
<b>Switching frequency</b>	4 Hz
<b>Output time</b>	41.6 ms
<b>Ultrasonic frequency (typical)</b>	120 kHz
<b>Detection area (typical)</b>	See diagrams
<b>Additional function</b>	Adjustable operating modes: Switching point (Dt0) / Switching window/Background (ObSB), teach-in of digital output, set levels of digital outputs, invertable digital output, set on delay digital output, synchronization of up to 50 sensors, multiplexing: no cross talk of up to 50 sensors, Adjustable measurement filters: Measured value filters/Filter strength/Foreground suppression/Detection area/Sensitivity and sound beam/False echo suppression, teach-in button(s) (can be deactivated), reset to factory default
<b>Safety-related parameters</b>	
	MTTF <sub>D</sub> 101 years
	DC <sub>avg</sub> 0 %

<sup>1)</sup> In relation to the current measured value, minimum value ≥ resolution.

<sup>2)</sup> Referring to current measurement value.

<sup>3)</sup> Temperature compensation can be switched off, without temperature compensation: 0.17 % / K.

<sup>4)</sup> Subsequent smoothing of the analog output, depending on the application, may increase the response time by up to 200 %.

## Interfaces

<b>IO-Link</b>	✓, IO-Link V1.1
----------------	-----------------

<sup>1)</sup> Push-pull: PNP/NPN HIGH = U<sub>V</sub> - (< 3 V) / LOW < 3 V.

	Function	Process data, parameterization, diagnosis, data storage
<b>Digital output</b>	Number	1 <sup>1)</sup>
	Type	Push-pull: PNP/NPN
	Maximum output current $I_A$	≤ 100 mA
<b>Multifunctional input (MF)</b>		1 x MF
<b>Hysteresis</b>		50 mm

<sup>1)</sup> Push-pull: PNP/NPN HIGH =  $U_V - (< 3 V)$  / LOW < 3 V.

### Electronics

<b>Supply voltage <math>U_B</math></b>	DC 9 V ... 30 V <sup>1) 2)</sup>
<b>Power consumption</b>	≤ 1.5 W <sup>3)</sup>
<b>Initialization time</b>	< 300 ms
<b>Indication</b>	4 x LED
<b>Enclosure rating</b>	IP65 IP67
<b>Protection class</b>	III

<sup>1)</sup> Limit values, reverse-polarity protected Operation in short-circuit protected network: max. 8 A, class 2.

<sup>2)</sup> 15 V ... 30 V when using the analog voltage output.

<sup>3)</sup> Without load.

### Mechanics

<b>Dimensions (W x H x D)</b>	40 mm x 40 mm x 66 mm
<b>Design</b>	Rectangular
<b>Sending axis</b>	Straight <sup>1)</sup>
<b>Housing material</b>	Plastic (PA 66, ultrasonic transducer: polyurethane foam, glass epoxy resin)
<b>Weight</b>	130 g
<b>Connection type</b>	Male connector, M12, 5-pin

<sup>1)</sup> Sensor head can be rotated 90°, additional 360° incremental alignment via mounting bracket.

### Ambient data

<b>Ambient temperature, operation</b>	-25 °C ... +70 °C
<b>Ambient temperature, storage</b>	-40 °C ... +85 °C

### Certificates

<b>EU declaration of conformity</b>	✓
<b>UK declaration of conformity</b>	✓
<b>ACMA declaration of conformity</b>	✓
<b>Moroccan declaration of conformity</b>	✓
<b>China RoHS</b>	✓
<b>cULus certificate</b>	✓
<b>Information according to Art. 3 of Data Act (Regulation EU 2023/2854)</b>	✓

### Classifications

<b>ECLASS 5.0</b>	27270804
-------------------	----------

# UC40-11411B | UC40

## ULTRASONIC DISTANCE SENSORS

<b>ECLASS 5.1.4</b>	27270804
<b>ECLASS 6.0</b>	27270804
<b>ECLASS 6.2</b>	27270804
<b>ECLASS 7.0</b>	27270804
<b>ECLASS 8.0</b>	27270804
<b>ECLASS 8.1</b>	27270804
<b>ECLASS 9.0</b>	27270804
<b>ECLASS 10.0</b>	27270804
<b>ECLASS 11.0</b>	27270804
<b>ECLASS 12.0</b>	27272806
<b>ETIM 5.0</b>	EC001846
<b>ETIM 6.0</b>	EC001846
<b>ETIM 7.0</b>	EC001846
<b>ETIM 8.0</b>	EC001846
<b>UNSPSC 16.0901</b>	41111960

### Dimensional drawing UC40-11411x

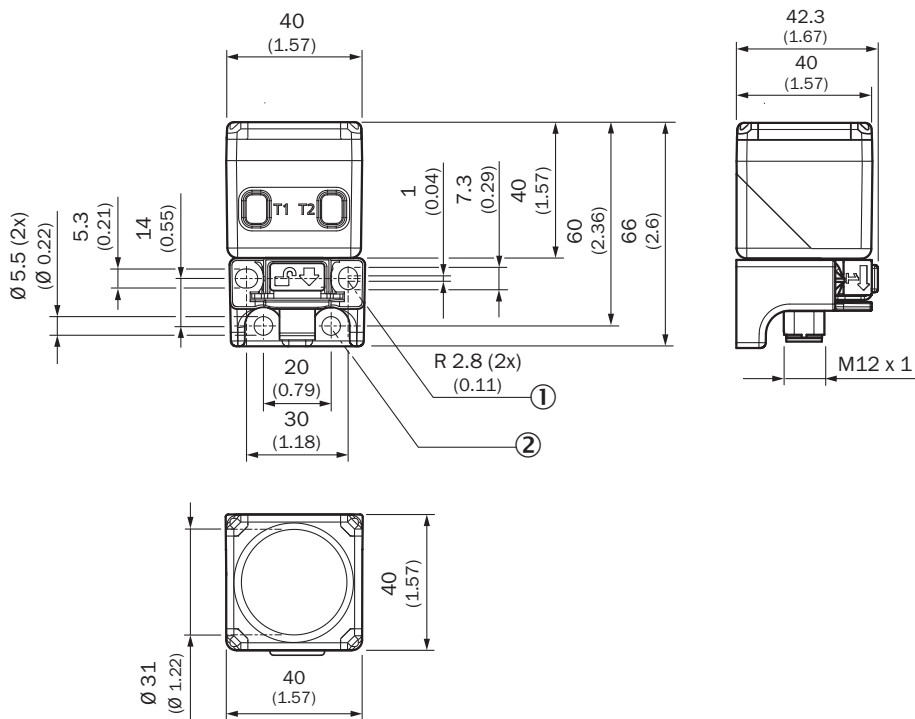

Dimensions in mm (inch)

- ① 2 mounting holes, radius: 2.8 mm
- ② 2 mounting holes, diameter: 5.5 mm

## Connection type

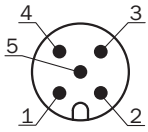

- ① L<sup>+</sup>: Supply voltage, brown
- ② N/C: Not assigned, white
- ③ M: Supply voltage 0 V, blue
- ④ Q/ $\bar{Q}$ /C: Digital output, IO-Link communication, black
- ⑤ MF: Multifunction input, synchronization and multiplex operation, communication via Connect+ software, gray

## Connection diagram

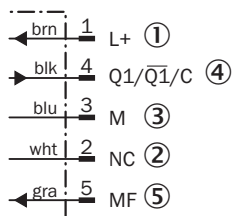

- ① Supply voltage
- ② Not assigned
- ③ Supply voltage: 0 V
- ④ Digital output 1, IO-Link communication
- ⑤ Multifunction input (MF), synchronization and multiplex operation, communication via Connect+ software

## Detection area

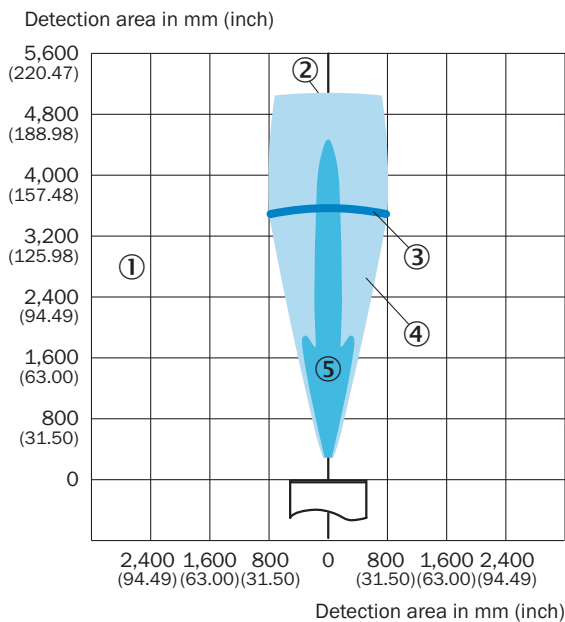







- ① Detection range dependent on reflection properties, size, and alignment of the object
- ② Limiting range
- ③ operating range
- ④ example object: aligned plate 500 mm x 500 mm

⑤ example object: pipe with 27 mm diameter

### Recommended accessories

Other models and accessories → [www.sick.com/UC40](http://www.sick.com/UC40)

	Brief description	Type	part no.
connectors and cables			
	<ul style="list-style-type: none"> <li><b>Description:</b> Sensor/actuator cable, unshielded</li> <li><b>Connection type head A:</b> Female connector, M12, 5-pin, straight, A-coded</li> <li><b>Connection type head B:</b> Flying leads</li> <li><b>Signal type:</b> Sensor/actuator cable</li> <li><b>Cable:</b> 2 m, 5-wire, PVC</li> <li><b>Application:</b> Untaminated zones, Zones with chemicals</li> </ul>	YF2A15-020VB5XLEAX	2096239
	<ul style="list-style-type: none"> <li><b>Description:</b> Sensor/actuator cable, unshielded</li> <li><b>Connection type head A:</b> Female connector, M12, 5-pin, straight, A-coded</li> <li><b>Connection type head B:</b> Flying leads</li> <li><b>Signal type:</b> Sensor/actuator cable</li> <li><b>Cable:</b> 0.6 m, 5-wire, PVC</li> <li><b>Application:</b> Untaminated zones, Zones with chemicals</li> </ul>	YF2A15-C60VB5XLEAX	2145570
	<ul style="list-style-type: none"> <li><b>Description:</b> Sensor/actuator cable, unshielded</li> <li><b>Connection type head A:</b> Female connector, M12, 5-pin, straight, A-coded</li> <li><b>Connection type head B:</b> Flying leads</li> <li><b>Signal type:</b> Sensor/actuator cable</li> <li><b>Cable:</b> 3 m, 5-wire, PVC</li> <li><b>Application:</b> Untaminated zones, Zones with chemicals</li> </ul>	YF2A15-030VB5XLEAX	2145572
network devices			
		SIG100-0A0111100	1089792
		SIG200-0A041220S01	1100615
		IOLA2US-01101 (SiLink2 Master)	1061790

## SICK AT A GLANCE

SICK is one of the leading manufacturers of intelligent sensors and sensor solutions for industrial applications. A unique range of products and services creates the perfect basis for controlling processes securely and efficiently, protecting individuals from accidents and preventing damage to the environment.

We have extensive experience in a wide range of industries and understand their processes and requirements. With intelligent sensors, we can deliver exactly what our customers need. In application centers in Europe, Asia and North America, system solutions are tested and optimized in accordance with customer specifications. All this makes us a reliable supplier and development partner.

Comprehensive services complete our offering: SICK LifeTime Services provide support throughout the machine life cycle and ensure safety and productivity.

For us, that is “Sensor Intelligence.”

## WORLDWIDE PRESENCE:

Contacts and other locations –[www.sick.com](http://www.sick.com)