



UFS3-37P115

UFS

FORK SENSORS

SICK
Sensor Intelligence.



Illustration may differ



Ordering information

Type	part no.
UFS3-37P115	6075489

Other models and accessories → www.sick.com/UFS

Detailed technical data

Features

Functional principle	Ultrasonic detection principle
Housing design	Fork shaped
Dimensions (W x H x D)	20 mm x 37.4 mm x 70 mm
Fork width	2.6 mm
Fork depth	42.5 mm
Label detection	✓
Minimum detectable object (MDO)	Label size: 2 mm ¹⁾ Label gap: 1 mm ¹⁾
Display	LED indicator green: power on LED indicator, yellow: Status switching output Q
Adjustment	Plus/minus button, cable (Teach-in, sensitivity, light/dark switching, Teach-in dynamic)
Teach-in mode	1-point teach-in 2-point teach-in Teach-in dynamic

¹⁾ Depends on the label thickness.

Interfaces

IO-Link	✓, V1.1
Data transmission rate	COM3 (230,4 kBaud)
Cycle time	4 ms
VendorID	26
DeviceID HEX	0x8002A6
DeviceID DEC	8389286

Process data length	16 Bit
Process data structure A	Bit 0 = switching signal Q_{L1} Bit 1 = switching signal Q_{L2} Bit 2 = switching signal Q_{Int1} Bit 3 = switching signal Q_{Int2} Bit 4 = alarm QoR Bit 5 = Teach busy Bit 6 ... 15 = measured value
Digital output	Q_1
Number	1

Electronics

Supply voltage	10 V DC ... 30 V DC ¹⁾
Ripple	< 10 % ²⁾
Current consumption	50 mA ³⁾
Initialization time	100 ms
Switching frequency	1.1 kHz ⁴⁾
Response time	≤ 440 μs
Jitter	40 μs
Switching output	PNP
Switching output (voltage)	PNP: HIGH = $V_S - 3 V$ / LOW = 0 V
Switching mode	Light/dark switching
Output current I_{max}	100 mA ⁵⁾
Input, teach-in (ET)	Teach: $U < 2 V$; Run: $U = 10 V \dots < U_V$
Protection class	III ⁶⁾
Circuit protection	U_V connections, reverse polarity protected Output Q short-circuit protected Interference pulse suppression
Connection type	Cable open end, 4-wire, 2 m
Connection type Detail	
Length of cable	2 m
Cable material	PVC
Cable diameter	Ø 3.5 mm
Conductor cross section	0.14 mm ²
Pinouts	
BN	+ (L+)
WH	MF _{In/Out}
BU	- (M)
BK	Q/C

¹⁾ Limit values, reverse-polarity protected, operation in short-circuit protected network: max. 8 A.

²⁾ May not fall below or exceed U_V tolerances.

³⁾ Without load.

⁴⁾ With light/dark ratio 1:1.

⁵⁾ Minimum output current 0.3 mA.

⁶⁾ Reference voltage DC 50 V.

Mechanics

Housing material	Zamak Glass fiber reinforced plastic
Weight	Approx. 100 g

Ambient data

Ambient operating temperature	+5 °C ... +55 °C ¹⁾
Ambient temperature, storage	-20 °C ... +70 °C
Shock load	According to EN 60068-2-27
EMC	EN 60947-5-2 ²⁾
Enclosure rating	IP65
UL File No.	NRKH.E191603 & NRKH7.E191603

¹⁾ Do not bend below 0 °C.

²⁾ The sensor complies with the Radio Safety Requirements (EMC) for the industrial sector (Radio Safety Class A). It may cause radio interference if used in a residential area.

Smart Task

Smart Task name	Base logics
------------------------	-------------

Certificates

EU declaration of conformity	✓
UK declaration of conformity	✓
ACMA declaration of conformity	✓
Moroccan declaration of conformity	✓
China RoHS	✓
cULus certificate	✓
IO-Link certificate	✓
Information according to Art. 3 of Data Act (Regulation EU 2023/2854)	✓

Classifications

ECLASS 5.0	27270909
ECLASS 5.1.4	27270909
ECLASS 6.0	27270909
ECLASS 6.2	27270909
ECLASS 7.0	27270909
ECLASS 8.0	27270909
ECLASS 8.1	27270909
ECLASS 9.0	27270909
ECLASS 10.0	27270909
ECLASS 11.0	27270909
ECLASS 12.0	27270909
ETIM 5.0	EC002720
ETIM 6.0	EC002720
ETIM 7.0	EC002720

ETIM 8.0	EC002720
UNSPSC 16.0901	39121528

Dimensional drawing, sensor

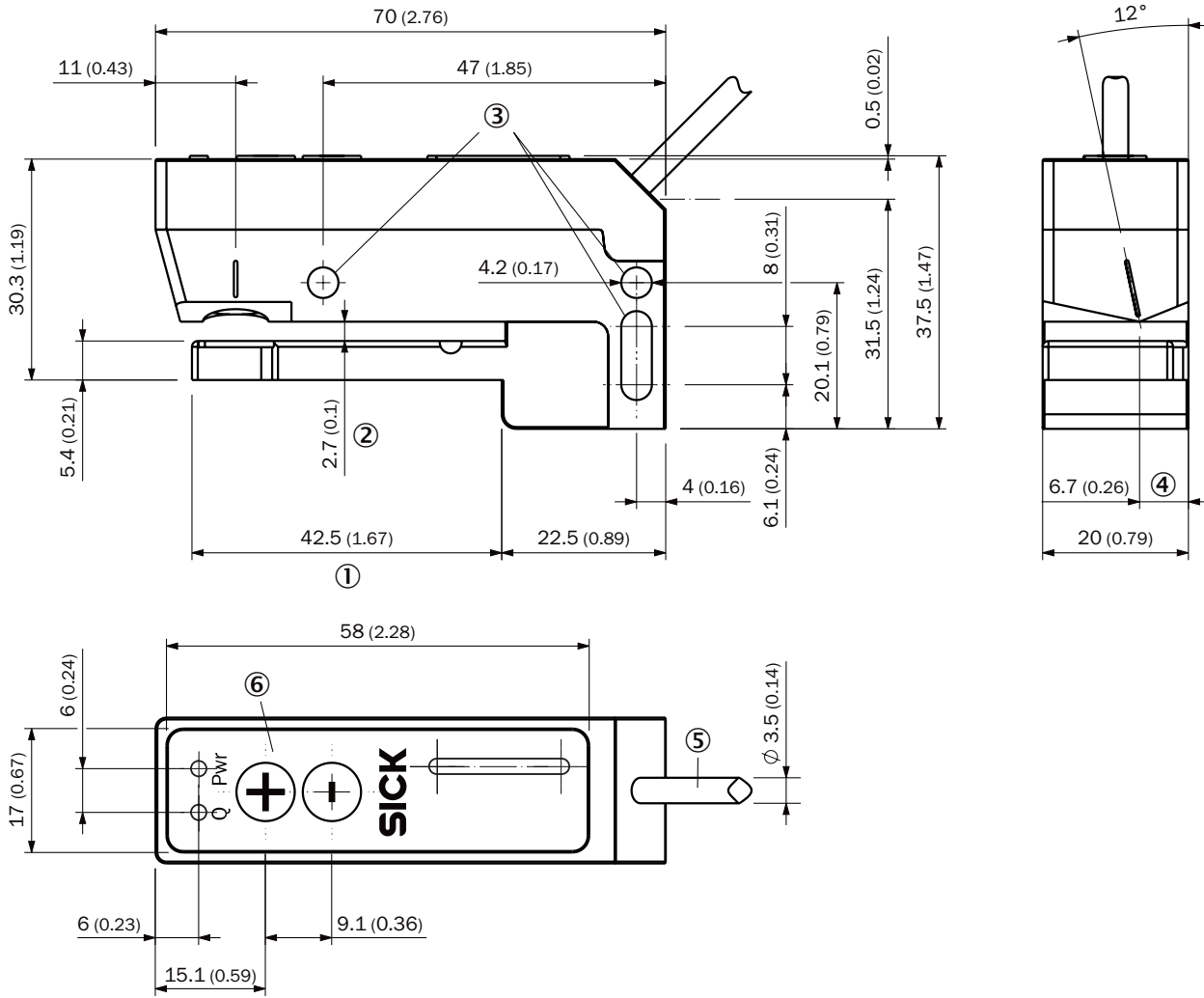

Dimensions in mm (inch)

- ① Fork depth
- ② Fork width
- ③ fixing hole
- ④ Detection axis
- ⑤ connection (see technical data for length of cable)
- ⑥ display and adjustment elements

display and adjustment elements

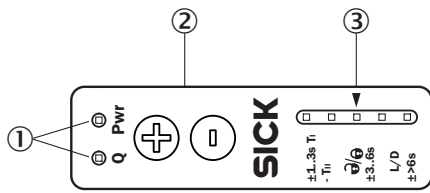





- ① LEDs (status display)
- ② Teach-in button
- ③ Bar graph

Recommended accessories

Other models and accessories → www.sick.com/UFS

	Brief description	Type	part no.
Mounting systems			
	<ul style="list-style-type: none"> • Description: WFS mounting rod, straight, including 2 x fixing screws • Material: Steel • Details: Aluminum 	BEF-M12GF-A	2059414

	Brief description	Type	part no.
network devices			
		IOLA2US-01101 (SiLink2 Master)	1061790
		SIG350-0004AP100	6076871
		SIG350-0005AP100	6076923
		SIG350-0006AP100	6076924
connectors and cables			
	<ul style="list-style-type: none"> • Description: Unshielded • Connection type head A: Male connector, M12, 4-pin, straight, A-coded • Connection systems: Screw-type terminals • Permitted cross-section: ≤ 0.75 mm² 	STE-1204-G	6009932

SICK AT A GLANCE

SICK is one of the leading manufacturers of intelligent sensors and sensor solutions for industrial applications. A unique range of products and services creates the perfect basis for controlling processes securely and efficiently, protecting individuals from accidents and preventing damage to the environment.

We have extensive experience in a wide range of industries and understand their processes and requirements. With intelligent sensors, we can deliver exactly what our customers need. In application centers in Europe, Asia and North America, system solutions are tested and optimized in accordance with customer specifications. All this makes us a reliable supplier and development partner.

Comprehensive services complete our offering: SICK LifeTime Services provide support throughout the machine life cycle and ensure safety and productivity.

For us, that is “Sensor Intelligence.”

WORLDWIDE PRESENCE:

Contacts and other locations –www.sick.com