



# UFS3-37B115

UFS

**FORK SENSORS**

**SICK**  
Sensor Intelligence.



Illustration may differ



### Ordering information

| Type        | part no. |
|-------------|----------|
| UFS3-37B115 | 6075488  |

Other models and accessories → [www.sick.com/UFS](http://www.sick.com/UFS)

### Detailed technical data

#### Features

|  |  |
|--|--|
| <b>Functional principle</b>            | Ultrasonic detection principle   |
| <b>Housing design</b>                  | Fork shaped  |
| <b>Dimensions (W x H x D)</b>          | 20 mm x 37.4 mm x 70 mm  |
| <b>Fork width</b>                      | 2.6 mm   |
| <b>Fork depth</b>                      | 42.5 mm  |
| <b>Label detection</b>                 | ✓  |
| <b>Minimum detectable object (MDO)</b> | Label size: 2 mm <sup>1)</sup><br>Label gap: 1 mm <sup>1)</sup>                          |
| <b>Display</b>                         | LED indicator green: power on<br>LED indicator, yellow: Status switching output Q        |
| <b>Adjustment</b>                      | Plus/minus button, cable (Teach-in, sensitivity, light/dark switching, Teach-in dynamic) |
| <b>Teach-in mode</b>                   | 1-point teach-in<br>2-point teach-in<br>Teach-in dynamic                                 |

<sup>1)</sup> Depends on the label thickness.

#### Interfaces

|                        |                    |
|------------------------|--------------------|
| <b>IO-Link</b>         | ✓, V1.1            |
| Data transmission rate | COM3 (230,4 kBaud) |
| Cycle time             | 4 ms               |
| VendorID               | 26                 |
| DeviceID HEX           | 0x8002A6           |
| DeviceID DEC           | 8389286            |

|                                 |  |
|---------------------------------|--|
| Process data length             | 16 Bit   |
| <b>Process data structure A</b> | Bit 0 = switching signal $Q_{L1}$<br>Bit 1 = switching signal $Q_{L2}$<br>Bit 2 = switching signal $Q_{Int1}$<br>Bit 3 = switching signal $Q_{Int2}$<br>Bit 4 = alarm QoR<br>Bit 5 = Teach busy<br>Bit 6 ... 15 = measured value |
| <b>Digital output</b>           | $Q_1$  |
| Number                          | 1  |

## Electronics

|  |   |
|--|---|
| <b>Supply voltage</b>                      | 10 V DC ... 30 V DC <sup>1)</sup>   |
| <b>Ripple</b>                              | < 10 % <sup>2)</sup>  |
| <b>Current consumption</b>                 | 50 mA <sup>3)</sup>   |
| <b>Initialization time</b>                 | 100 ms  |
| <b>Switching frequency</b>                 | 1.1 kHz <sup>4)</sup>   |
| <b>Response time</b>                       | ≤ 440 μs  |
| <b>Jitter</b>                              | 40 μs   |
| <b>Switching output</b>                    | Push-pull: PNP/NPN  |
| <b>Switching output (voltage)</b>          | Push-pull: PNP/NPN High = $U_V - < 2$ V/Low: ≤ 2 V  |
| <b>Switching mode</b>                      | Light/dark switching  |
| <b>Output current <math>I_{max}</math></b> | 100 mA <sup>5)</sup>  |
| <b>Protection class</b>                    | III <sup>6)</sup>   |
| <b>Circuit protection</b>                  | $U_V$ connections, reverse polarity protected<br>Output Q short-circuit protected<br>Interference pulse suppression |
| <b>Connection type</b>                     | Cable open end, 4-wire, 2 m   |
| <b>Connection type Detail</b>              |   |
| Length of cable                            | 2 m   |
| Cable material                             | PVC   |
| Cable diameter                             | Ø 3.5 mm  |
| Conductor cross section                    | 0.14 mm <sup>2</sup>  |
| <b>Pinouts</b>                             |   |
| BN   | + (L+)  |
| WH   | MF <sub>In/Out</sub>  |
| BU   | - (M)   |
| BK   | Q/C   |

<sup>1)</sup> Limit values, reverse-polarity protected, operation in short-circuit protected network: max. 8 A.

<sup>2)</sup> May not fall below or exceed  $U_V$  tolerances.

<sup>3)</sup> Without load.

<sup>4)</sup> With light/dark ratio 1:1.

<sup>5)</sup> Minimum output current 0.3 mA.

<sup>6)</sup> Reference voltage DC 50 V.

### Mechanics

|                         |   |
|-------------------------|---|
| <b>Housing material</b> | Zamak<br>Glass fiber reinforced plastic |
| <b>Weight</b>           | Approx. 100 g                           |

### Ambient data

|                                      |                                |
|--------------------------------------|--------------------------------|
| <b>Ambient operating temperature</b> | +5 °C ... +55 °C <sup>1)</sup> |
| <b>Ambient temperature, storage</b>  | -20 °C ... +70 °C              |
| <b>Shock load</b>                    | According to EN 60068-2-27     |
| <b>EMC</b>                           | EN 60947-5-2 <sup>2)</sup>     |
| <b>Enclosure rating</b>              | IP65                           |
| <b>UL File No.</b>                   | NRKH.E191603 & NRKH7.E191603   |

<sup>1)</sup> Do not bend below 0 °C.

<sup>2)</sup> The sensor complies with the Radio Safety Requirements (EMC) for the industrial sector (Radio Safety Class A). It may cause radio interference if used in a residential area.

### Smart Task

|                        |             |
|------------------------|-------------|
| <b>Smart Task name</b> | Base logics |
|------------------------|-------------|

### Certificates

|  |   |
|--|---|
| <b>EU declaration of conformity</b>  | ✓ |
| <b>UK declaration of conformity</b>  | ✓ |
| <b>ACMA declaration of conformity</b>  | ✓ |
| <b>Moroccan declaration of conformity</b>                                    | ✓ |
| <b>China RoHS</b>  | ✓ |
| <b>cULus certificate</b>   | ✓ |
| <b>IO-Link certificate</b>   | ✓ |
| <b>Information according to Art. 3 of Data Act (Regulation EU 2023/2854)</b> | ✓ |

### Classifications

|                     |          |
|---------------------|----------|
| <b>ECLASS 5.0</b>   | 27270909 |
| <b>ECLASS 5.1.4</b> | 27270909 |
| <b>ECLASS 6.0</b>   | 27270909 |
| <b>ECLASS 6.2</b>   | 27270909 |
| <b>ECLASS 7.0</b>   | 27270909 |
| <b>ECLASS 8.0</b>   | 27270909 |
| <b>ECLASS 8.1</b>   | 27270909 |
| <b>ECLASS 9.0</b>   | 27270909 |
| <b>ECLASS 10.0</b>  | 27270909 |
| <b>ECLASS 11.0</b>  | 27270909 |
| <b>ECLASS 12.0</b>  | 27270909 |
| <b>ETIM 5.0</b>     | EC002720 |
| <b>ETIM 6.0</b>     | EC002720 |
| <b>ETIM 7.0</b>     | EC002720 |

|                |          |
|----------------|----------|
| ETIM 8.0       | EC002720 |
| UNSPSC 16.0901 | 39121528 |

Dimensional drawing, sensor

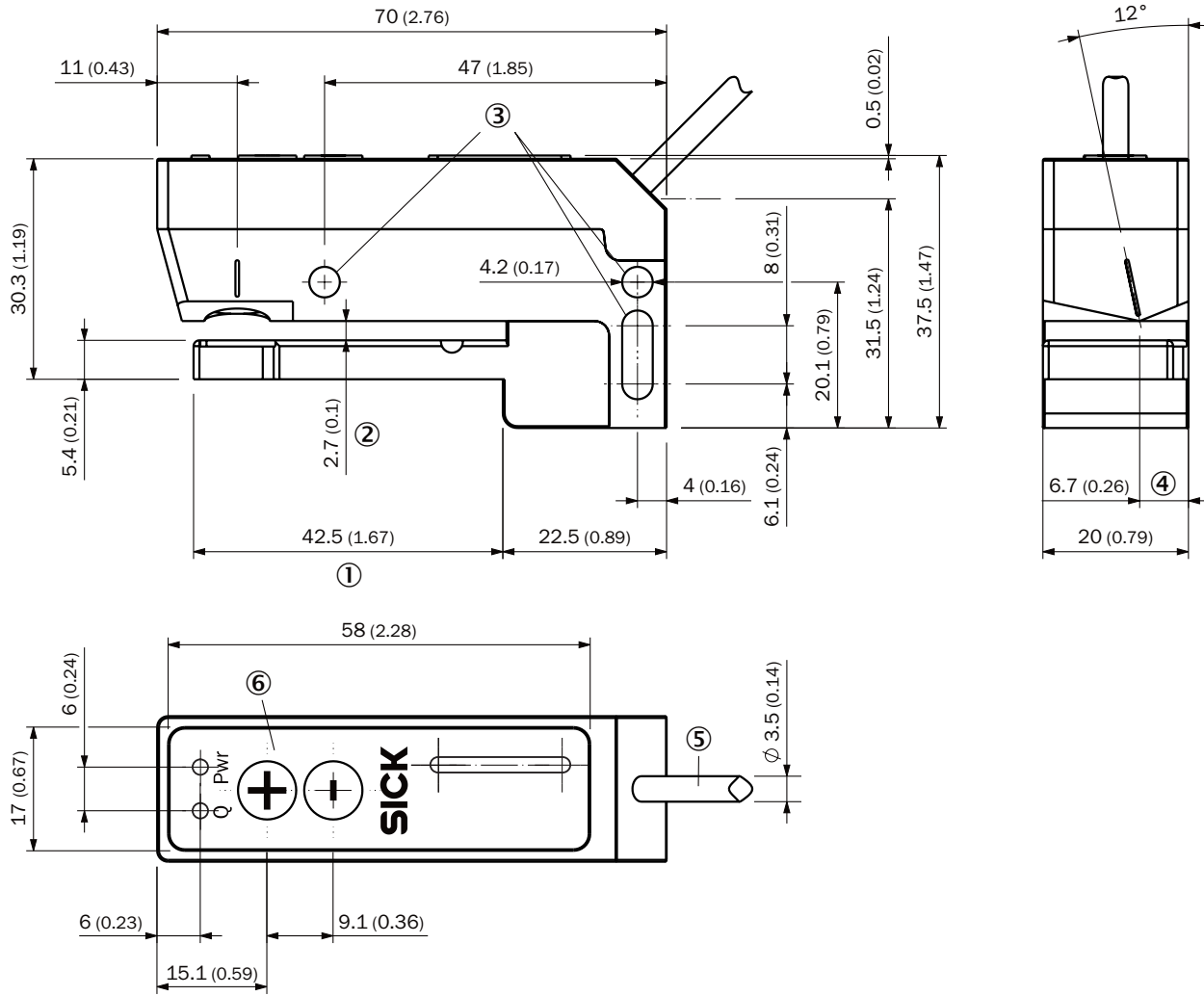

Dimensions in mm (inch)

- ① Fork depth
- ② Fork width
- ③ fixing hole
- ④ Detection axis
- ⑤ connection (see technical data for length of cable)
- ⑥ display and adjustment elements

### display and adjustment elements

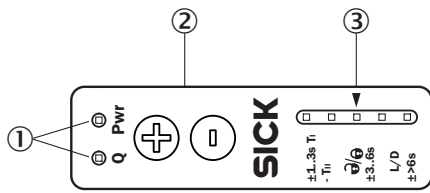





- ① LEDs (status display)
- ② Teach-in button
- ③ Bar graph

### Recommended accessories

Other models and accessories → [www.sick.com/UFS](http://www.sick.com/UFS)

|   | Brief description   | Type        | part no. |
|---|---|-------------|----------|
| Mounting systems  |   |             |          |
|  | <ul style="list-style-type: none"> <li>• <b>Description:</b> WFS mounting rod, straight, including 2 x fixing screws</li> <li>• <b>Material:</b> Steel</li> <li>• <b>Details:</b> Aluminum</li> </ul> | BEF-M12GF-A | 2059414  |

|   | Brief description  | Type                              | part no. |
|---|--|-----------------------------------|----------|
| network devices   |  |                                   |          |
|    |  | IOLA2US-01101<br>(SiLink2 Master) | 1061790  |
|    |  | SIG350-0004AP100                  | 6076871  |
|    |  | SIG350-0005AP100                  | 6076923  |
|    |  | SIG350-0006AP100                  | 6076924  |
| connectors and cables   |  |                                   |          |
|  | <ul style="list-style-type: none"> <li>• <b>Description:</b> Unshielded</li> <li>• <b>Connection type head A:</b> Male connector, M12, 4-pin, straight, A-coded</li> <li>• <b>Connection systems:</b> Screw-type terminals</li> <li>• <b>Permitted cross-section:</b> ≤ 0.75 mm<sup>2</sup></li> </ul> | STE-1204-G                        | 6009932  |

## SICK AT A GLANCE

SICK is one of the leading manufacturers of intelligent sensors and sensor solutions for industrial applications. A unique range of products and services creates the perfect basis for controlling processes securely and efficiently, protecting individuals from accidents and preventing damage to the environment.

We have extensive experience in a wide range of industries and understand their processes and requirements. With intelligent sensors, we can deliver exactly what our customers need. In application centers in Europe, Asia and North America, system solutions are tested and optimized in accordance with customer specifications. All this makes us a reliable supplier and development partner.

Comprehensive services complete our offering: SICK LifeTime Services provide support throughout the machine life cycle and ensure safety and productivity.

For us, that is “Sensor Intelligence.”

## WORLDWIDE PRESENCE:

Contacts and other locations –[www.sick.com](http://www.sick.com)