



GLL170-P334S08

GLL170

FIBER-OPTIC SENSORS

SICK
Sensor Intelligence.



Illustration may differ



Ordering information

Type	part no.
GLL170-P334S08	6073294

Other models and accessories → www.sick.com/GLL170

Detailed technical data

Features

Device type	Fiber-optic amplifier
Device type detail	Stand-alone
Functional principle detail	Depending on the optical fiber cable used
Sensing range max.	Depending on the optical fiber cable used
Emitted beam	
Light source	LED ¹⁾
Type of light	Visible red light
Key LED figures	
Normative reference	EN 62471:2008-09 IEC 62471:2006, modified
LED risk group marking	Free group
Wave length	632 nm
Average service life	100,000 h at T _a = +25 °C
Adjustment	
Potentiometer	For setting the sensing range/for setting the switching mode/for adjusting the switch-off delay
Display	
LED green	Operating indicator Static on: power on Dimmed in the range +/- 10 % of the switching threshold
LED yellow	Status of digital output Permanently on: Switching output active Permanently off: Digital output not active
Special features	Reduced transmitting power, 300 μs response time

¹⁾ Average service life: 100,000 h at T_J = +25 °C.

Items supplied	BEF-WLL180 mounting bracket
-----------------------	-----------------------------

¹⁾ Average service life: 100,000 h at $T_U = +25$ °C.

Safety-related parameters

MTTF_D	760 years
DC_{avg}	0 %
T_M (mission time)	20 years

Electronics

Supply voltage U_B	10 V DC ... 30 V DC ¹⁾
Ripple	≤ 10 % ²⁾
Current consumption	≤ 30 mA ³⁾
Protection class	III
Digital output	
Number	1
Type	PNP ⁴⁾
Switching mode	Light/dark switching
Signal voltage PNP HIGH/LOW	Approx. U _B -1.5 V / 0 V
Signal voltage NPN HIGH/LOW	Approx. U _B / < 1.5 V
Output current I _{max}	≤ 100 mA
Circuit protection outputs	Reverse polarity protected
	Overcurrent protected
	Short-circuit protected
Response time	≤ 660 μs
Switching frequency	750 Hz
Time functions	Without time delay, off delay
Delay time	Selectable via rotary switch, 0 ms ... 40 ms
Pin/Wire assignment	
Function of pin 4/black (BK)	Digital output, received light → Output Q1 HIGH
Function of pin 4/black (BK) – detail	The pin 4 function of the sensor can be configured

¹⁾ Limit values.

²⁾ May not fall below or exceed U_y tolerances.

³⁾ Without load.

⁴⁾ Selectable via rotary switch.

Mechanics

Housing	Rectangular
Dimensions (W x H x D)	10 mm x 31.7 mm x 72.5 mm
Connection	Male connector M8, 4-pin
Connection detail	
Conductor size	0.2 mm ²
Cable diameter	Ø 3.8 mm
Material	
Housing	Plastic, PC/POM

	Cable	Plastic, PVC
Weight		19 g
Maximum tightening torque of the fixing screws		0.5 Nm

Ambient data

Enclosure rating	IP66 (EN 60529)
Ambient operating temperature	-25 °C ... +55 °C
Ambient temperature, storage	-40 °C ... +70 °C
Typ. Ambient light immunity	Artificial light: ≤ 5,000 lx Sunlight: ≤ 60,000 lx
Shock resistance	50 g, 11 ms (3 positive and 3 negative shocks along X, Y, Z axes, 18 total shocks (EN60068-2-27))
Vibration resistance	10 Hz ... 55 Hz (Amplitude 1 mm, 3 x 30 min (EN60068-2-6))
Air humidity	35 % ... 95 %, relative humidity (no condensation)
Electromagnetic compatibility (EMC)	EN 60947-5-2
UL File No.	NRKH2.E300503 & NRKH8.E300503
RoHS certificate	✓

Smart Task

Timer function	Deactivated Switch-on delay Off delay Impulse (one shot)
-----------------------	---

Certificates

EU declaration of conformity	✓
UK declaration of conformity	✓
ACMA declaration of conformity	✓
Moroccan declaration of conformity	✓
China RoHS	✓
cRUus certificate	✓

Classifications

ECLASS 5.0	27270905
ECLASS 5.1.4	27270905
ECLASS 6.0	27270905
ECLASS 6.2	27270905
ECLASS 7.0	27270905
ECLASS 8.0	27270905
ECLASS 8.1	27270905
ECLASS 9.0	27270905
ECLASS 10.0	27270905
ECLASS 11.0	27270905
ECLASS 12.0	27270905
ETIM 5.0	EC002651
ETIM 6.0	EC002651

ETIM 7.0	EC002651
ETIM 8.0	EC002651
UNSPSC 16.0901	39121528

Adjustments GLL170

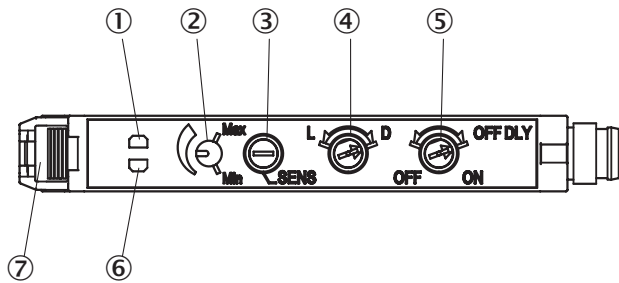

- ① LED indicator orange, lights up when switching output is active
- ② Sensitivity scale 230°
- ③ Sensitivity control: potentiometer, 8 turns
- ④ Selector switch: "L.ON" (light switching) /"D.ON" (dark switching)
- ⑤ OFF delay selector switch: "ON" (on)/"OFF" (off), 40 ms fixed
- ⑥ LED signal strength indicator green, lights up, when light received < 0.9 or >1.1 (switching threshold = 1)
- ⑦ Locking the fiber-optic cables

Connection diagram Cd-066

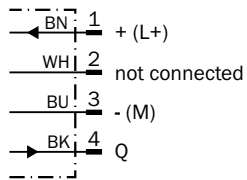

Dimensional drawing

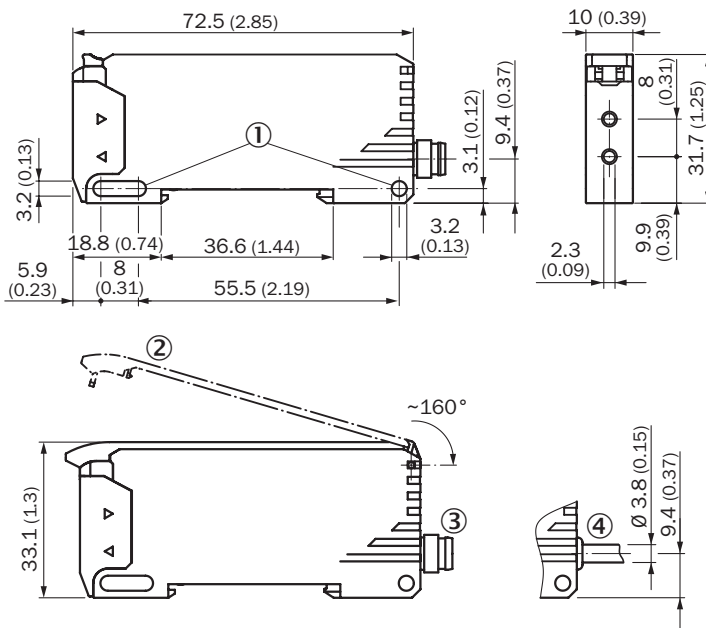



Dimensions in mm (inch)





- ① Mounting holes
- ② protective hood (optional), opens approx. 160°
- ③ Connector M8
- ④ cable

Recommended accessories



Other models and accessories → www.sick.com/GLL170

	Brief description	Type	part no.
device protection and care			
	<ul style="list-style-type: none"> Description: Protective Hood for GLL170, opens approx. 160° Usable for: Fiber-optic sensors 	BF-GLL170	5336263
	<ul style="list-style-type: none"> Description: Protective Hood for WLL80, opens approx. 180° Usable for: Fiber-optic sensors 	BF-WLL80	5344219
Mounting systems			
	<ul style="list-style-type: none"> Description: Mounting bracket Material: Steel Details: Steel, zinc coated Items supplied: Without mounting hardware Usable for: Fiber-optic sensors Suitable for: WLL180T, GLL170(T) 	BEF-WLL180	5325812

	Brief description	Type	part no.
fiber-optic sensors			
	<ul style="list-style-type: none"> • For fiber optic amplifiers: GLL70, WLL80, WLL180, GLL170(T), WLL24 Ex, KTL180 • Functional principle: Proximity system • Fiber length: 2,000 mm • Thread diameter (housing): M6 • Fiber material: Plastic • Jacket material: Plastic • Fiber head material: Stainless steel • Included with delivery: Mounting, 2 x M6 hexagon nut, 2 x washer, FC fiber cutter (5304141) 	LL3-DB01	5308074
	<ul style="list-style-type: none"> • For fiber optic amplifiers: GLL70, WLL80, WLL180, GLL170(T) • Functional principle: Proximity system • Fiber length: 2,000 mm • Thread diameter (housing): M3 • Fiber material: Plastic • Jacket material: Plastic • Fiber head material: Stainless steel • Included with delivery: Mounting, 2 x M3 hexagon nut, 2 x washer, adapter sleeves, BF-WLL160-13 (1.3 mm) adapter sleeves, FC fiber cutter (5304141) 	LL3-DT01	5308076
	<ul style="list-style-type: none"> • For fiber optic amplifiers: GLL70, WLL80, WLL180, GLL170(T), WLL24 Ex • Functional principle: Proximity system • Fiber length: 2,000 mm • Thread diameter (housing): M6 • Fiber material: Plastic • Jacket material: Plastic • Fiber head material: Stainless steel • Included with delivery: Mounting, 2 x M6 hexagon nut, 2 x washer, FC fiber cutter (5304141) 	LL3-DB02	5308083
	<ul style="list-style-type: none"> • For fiber optic amplifiers: GLL70, WLL80, WLL180, GLL170(T), WLL24 Ex • Functional principle: Through-beam system • Fiber length: 2,000 mm • Thread diameter (housing): M4 • Fiber material: Plastic • Jacket material: Plastic • Fiber head material: Stainless steel • Included with delivery: Mounting, 4 x M4 hexagon nut, 4 x washer, FC fiber cutter (5304141) 	LL3-TB01	5308050
	<ul style="list-style-type: none"> • For fiber optic amplifiers: GLL70, WLL80, WLL180, GLL170(T), WLL24 Ex • Functional principle: Proximity system • Fiber length: 2,000 mm • Thread diameter (housing): M6 • Fiber material: Plastic • Jacket material: Plastic • Fiber head material: Plastic • Included with delivery: Mounting, 1 x M6 hexagon nut, FC fiber cutter (5304141) 	LL3-DV05	5322549
	<ul style="list-style-type: none"> • For fiber optic amplifiers: GLL70, WLL80, WLL180, GLL170(T), WLL24 Ex • Functional principle: Through-beam system • Fiber length: 2,000 mm • Thread diameter (housing): M4 • Fiber material: Plastic • Jacket material: Plastic • Fiber head material: Plastic • Included with delivery: Mounting, 2 x M4 hexagon nut, FC fiber cutter (5304141) 	LL3-TV05	5322546
	<ul style="list-style-type: none"> • For fiber optic amplifiers: GLL70, WLL80, WLL180, GLL170(T), WLL24 Ex • Functional principle: Through-beam system • Fiber length: 2,000 mm • Fiber-optic head array width: 40 mm • Fiber material: Plastic • Jacket material: Plastic • Fiber head material: Plastic • Included with delivery: Mounting, 4 x M3 Phillips-head screw, FC fiber cutter (5304141), protective cladding for fiber head 	LL3-TS40	5323971
	<ul style="list-style-type: none"> • For fiber optic amplifiers: GLL70, WLL80, WLL180, GLL170(T), WLL24 Ex • Functional principle: Through-beam system • Fiber length: 20,000 mm • Thread diameter (housing): M12 • Fiber material: Plastic • Jacket material: Plastic • Fiber head material: Stainless steel • Included with delivery: Mounting, 4 x M12 hexagon nut, FC fiber cutter (5304141), protective cladding for fiber head 	LL3-TX01	5324173
	<ul style="list-style-type: none"> • For fiber optic amplifiers: GLL70, WLL80, WLL180, GLL170(T) • Functional principle: Proximity system 	LL3-DR11	5326000

	Brief description	Type	part no.
	<ul style="list-style-type: none"> • Fiber length: 2,000 mm • Smooth sleeve diameter: 3 mm • Fiber material: Plastic • Jacket material: Plastic • Fiber head material: Stainless steel • Included with delivery: Adapter sleeves, 1 x BF-WLL160-10 (1.0 mm) adapter sleeve, 1 x BF-WLL160-13 (1.3 mm) adapter sleeve, FC fiber cutter (5304141) 		
	<ul style="list-style-type: none"> • For fiber optic amplifiers: GLL70, WLL80, WLL180, GLL170(T), WLL24 Ex, KTL180 • Functional principle: Proximity system • Fiber length: 2,000 mm • Fiber material: Plastic • Jacket material: Plastic • Fiber head material: Plastic • Included with delivery: Adapter sleeves, BF-WLL160-10 (1.0 mm) adapter sleeves, FC fiber cutter (5304141) 	LL3-DC38	5322472
	<ul style="list-style-type: none"> • For fiber optic amplifiers: GLL70, WLL80, WLL180, GLL170(T) • Functional principle: Through-beam system • Fiber length: 2,000 mm • Thread diameter (housing): M4 • Fiber material: Glass • Jacket material: Stainless steel • Fiber head material: Brass 	LL3-TH08	5325978
	<ul style="list-style-type: none"> • For fiber optic amplifiers: GLL70, WLL80, WLL180, GLL170(T), WLL24 Ex • Functional principle: Through-beam system • Fiber length: 2,000 mm • Smooth sleeve diameter: 6 mm • Fiber material: Plastic • Jacket material: Chemical-resistant plastic • Fiber head material: Chemical-resistant plastic • Included with delivery: FC fiber cutter (5304141) 	LL3-TY01	5308066

	Brief description	Type	part no.
connectors and cables			
	<ul style="list-style-type: none"> • Connection type head A: Female connector, M8, 4-pin, straight, A-coded • Description: Unshielded • Connection systems: Screw-type terminals • Permitted cross-section: 0.14 mm² ... 0.5 mm² 	DOS-0804-G	6009974
	<ul style="list-style-type: none"> • Connection type head A: Female connector, M8, 4-pin, angled, A-coded • Description: Unshielded • Connection systems: Solder connection • Permitted cross-section: ≤ 0.25 mm² 	DOS-0804-W	6009975
	<ul style="list-style-type: none"> • Connection type head A: Male connector, M8, 4-pin, straight, A-coded • Description: Unshielded • Connection systems: Screw-type terminals • Permitted cross-section: 0.14 mm² ... 0.5 mm² 	STE-0804-G	6037323
	<ul style="list-style-type: none"> • Connection type head A: Female connector, M8, 4-pin, straight, A-coded • Connection type head B: Flying leads • Signal type: Sensor/actuator cable • Cable: 2 m, 4-wire, PVC • Description: Sensor/actuator cable, unshielded • Application: Zones with chemicals, Uncontaminated zones 	YF8U14-020VA3XLEAX	2095888
	<ul style="list-style-type: none"> • Connection type head A: Female connector, M8, 4-pin, straight, A-coded • Connection type head B: Flying leads • Signal type: Sensor/actuator cable • Cable: 5 m, 4-wire, PVC • Description: Sensor/actuator cable, unshielded • Application: Zones with chemicals, Uncontaminated zones 	YF8U14-050VA3XLEAX	2095889
	<ul style="list-style-type: none"> • Connection type head A: Female connector, M8, 4-pin, straight, A-coded • Connection type head B: Flying leads • Signal type: Sensor/actuator cable • Cable: 10 m, 4-wire, PVC • Description: Sensor/actuator cable, unshielded • Application: Zones with chemicals, Uncontaminated zones 	YF8U14-100VA3XLEAX	2095890
	<ul style="list-style-type: none"> • Connection type head A: Female connector, M8, 4-pin, angled, A-coded • Connection type head B: Flying leads • Signal type: Sensor/actuator cable • Cable: 2 m, 4-wire, PVC • Description: Sensor/actuator cable, unshielded • Application: Zones with chemicals, Uncontaminated zones 	YG8U14-020VA3XLEAX	2095962
	<ul style="list-style-type: none"> • Connection type head A: Female connector, M8, 4-pin, angled, A-coded • Connection type head B: Flying leads • Signal type: Sensor/actuator cable • Cable: 5 m, 4-wire, PVC • Description: Sensor/actuator cable, unshielded • Application: Zones with chemicals, Uncontaminated zones 	YG8U14-050VA3XLEAX	2095963
	<ul style="list-style-type: none"> • Connection type head A: Female connector, M8, 4-pin, angled, A-coded • Connection type head B: Flying leads • Signal type: Sensor/actuator cable • Cable: 10 m, 4-wire, PVC • Description: Sensor/actuator cable, unshielded • Application: Zones with chemicals, Uncontaminated zones 	YG8U14-100VA3XLEAX	2095964
	<ul style="list-style-type: none"> • Connection type head A: Female connector, M8, 4-pin, straight, A-coded • Connection type head B: Flying leads • Signal type: Sensor/actuator cable • Cable: 0.6 m, 4-wire, PVC • Description: Sensor/actuator cable, unshielded • Application: Zones with chemicals, Uncontaminated zones 	YF8U14-C60VA3XLEAX	2145852
	<ul style="list-style-type: none"> • Connection type head A: Female connector, M8, 4-pin, straight, A-coded • Connection type head B: Flying leads • Signal type: Sensor/actuator cable • Cable: 1 m, 4-wire, PVC • Description: Sensor/actuator cable, unshielded 	YF8U14-010VA3XLEAX	2145853

	Brief description	Type	part no.
	<ul style="list-style-type: none"> • Application: Zones with chemicals, Uncontaminated zones • Connection type head A: Female connector, M8, 4-pin, angled, A-coded • Connection type head B: Flying leads • Signal type: Sensor/actuator cable • Cable: 0.6 m, 4-wire, PVC • Description: Sensor/actuator cable, unshielded • Application: Zones with chemicals, Uncontaminated zones 	<p>YG8U14-C60VA3XLEAX</p>	<p>2145854</p>
	<ul style="list-style-type: none"> • Connection type head A: Female connector, M8, 4-pin, angled, A-coded • Connection type head B: Flying leads • Signal type: Sensor/actuator cable • Cable: 3 m, 4-wire, PVC • Description: Sensor/actuator cable, unshielded • Application: Zones with chemicals, Uncontaminated zones 	<p>YG8U14-030VA3XLEAX</p>	<p>2145857</p>
	<ul style="list-style-type: none"> • Connection type head A: Female connector, M8, 4-pin, angled, A-coded • Connection type head B: Flying leads • Signal type: Sensor/actuator cable • Cable: 1 m, 4-wire, PVC • Description: Sensor/actuator cable, unshielded • Application: Zones with chemicals, Uncontaminated zones 	<p>YG8U14-010VA3XLEAX</p>	<p>2145855</p>

SICK AT A GLANCE

SICK is one of the leading manufacturers of intelligent sensors and sensor solutions for industrial applications. A unique range of products and services creates the perfect basis for controlling processes securely and efficiently, protecting individuals from accidents and preventing damage to the environment.

We have extensive experience in a wide range of industries and understand their processes and requirements. With intelligent sensors, we can deliver exactly what our customers need. In application centers in Europe, Asia and North America, system solutions are tested and optimized in accordance with customer specifications. All this makes us a reliable supplier and development partner.

Comprehensive services complete our offering: SICK LifeTime Services provide support throughout the machine life cycle and ensure safety and productivity.

For us, that is “Sensor Intelligence.”

WORLDWIDE PRESENCE:

Contacts and other locations –www.sick.com