



TR4-SDU01CB

TR4 Direct

NON-CONTACT SAFETY SWITCHES

SICK
Sensor Intelligence.



Ordering information

Type	part no.
TR4-SDU01CB	6070808

Other models and accessories → www.sick.com/TR4_Direct



Detailed technical data

Features

System part	Sensor with actuator
Sensor principle	RFID
Number of safe outputs	2
Assured switch on distance S_{ao}	15 mm
Assured switch off distance S_{ar}	25 mm
Active sensor surfaces	2
Actuation directions	5
Coding	Uniquely coded

Safety-related parameters

Safety integrity level	SIL 3 (IEC 61508)
Category	Category 4 (EN ISO 13849)
Performance level	PL e (EN ISO 13849)
PFH_D (mean probability of a dangerous failure per hour)	$6.03 * 10^{-10}$
T_M (mission time)	20 years (EN ISO 13849)
Type	Type 4 (EN ISO 14119)
Actuator coding level	High coding level (EN ISO 14119)
Classification in compliance with IEC/EN 60947-5-3	PDF-M
Safe state in the event of a fault	At least one safety-related semiconductor output (OSSD) is in the OFF state.

Functions

Safe series connection	With Flexi Loop (with diagnostics) With T-connector (without diagnostics)
-------------------------------	--

Interfaces

Connection type	Cable with plug M12, 8-pin
Length of cable	0.2 m
Long connecting cable	≤ 200 m
Cable diameter	6.5 mm

Conductor cross section	0.25 mm ²
Bend radius (with fixed installation)	> 7 x cable diameter
Bend radius (with moving cable)	> 14 x cable diameter
Cable material	PVC
Conductor material	Copper
Coupling nut material	Nickel-plated brass
Display elements	LEDs
Status display	✓

Electronics

Protection class	III (EN 50178)
Classification according to cULus	Class 2
Supply voltage V_s	24 V DC (20.4 V DC ... 26.4 V DC)
Power consumption	≤ 50 mA
Type of output	Self-monitoring semiconductor outputs (OSSDs)
Output current	≤ 200 mA
Response time	45 ms ¹⁾
Release time	360 ms ²⁾
Risk time	≤ 100 ms ³⁾
Switch-on time	2 s ⁴⁾
Electrical life	10 x 10 ⁶ switching cycles

¹⁾ In a safe series connection, each downstream safety switch increases the system response time. More response times can be found in the operating instructions.

²⁾ Response time on approach to the enable zone.

³⁾ Detection time for external faults (e.g., short-circuit or cross-circuit of output signal switching devices). Follow the detailed information in the operating instructions.

⁴⁾ After application of the supply voltage to the safety switch.

Mechanics

Design	Rectangular
Dimensions (W x H x D)	25 mm x 88 mm x 20 mm
Weight	112 g
Housing material	Valox® DR48

Ambient data

Enclosure rating	IP67 (IEC 60529) IP69K (ISO 20653)
Ambient operating temperature	-25 °C ... +70 °C
Vibration resistance	10 Hz ... 55 Hz, 3.5 mm (IEC 60068-2-6)
Shock resistance	30 g, 11 ms (EN 60068-2-27)

Classifications

ECLASS 5.0	27272403
ECLASS 5.1.4	27272403
ECLASS 6.0	27272403
ECLASS 6.2	27272403
ECLASS 7.0	27272403

TR4-SDU01CB | TR4 Direct

NON-CONTACT SAFETY SWITCHES

ECLASS 8.0	27272403
ECLASS 8.1	27272403
ECLASS 9.0	27272403
ECLASS 10.0	27272403
ECLASS 11.0	27272403
ECLASS 12.0	27274601
ETIM 5.0	EC001829
ETIM 6.0	EC001829
ETIM 7.0	EC001829
ETIM 8.0	EC001829
UNSPSC 16.0901	39122205

Dimensional drawing

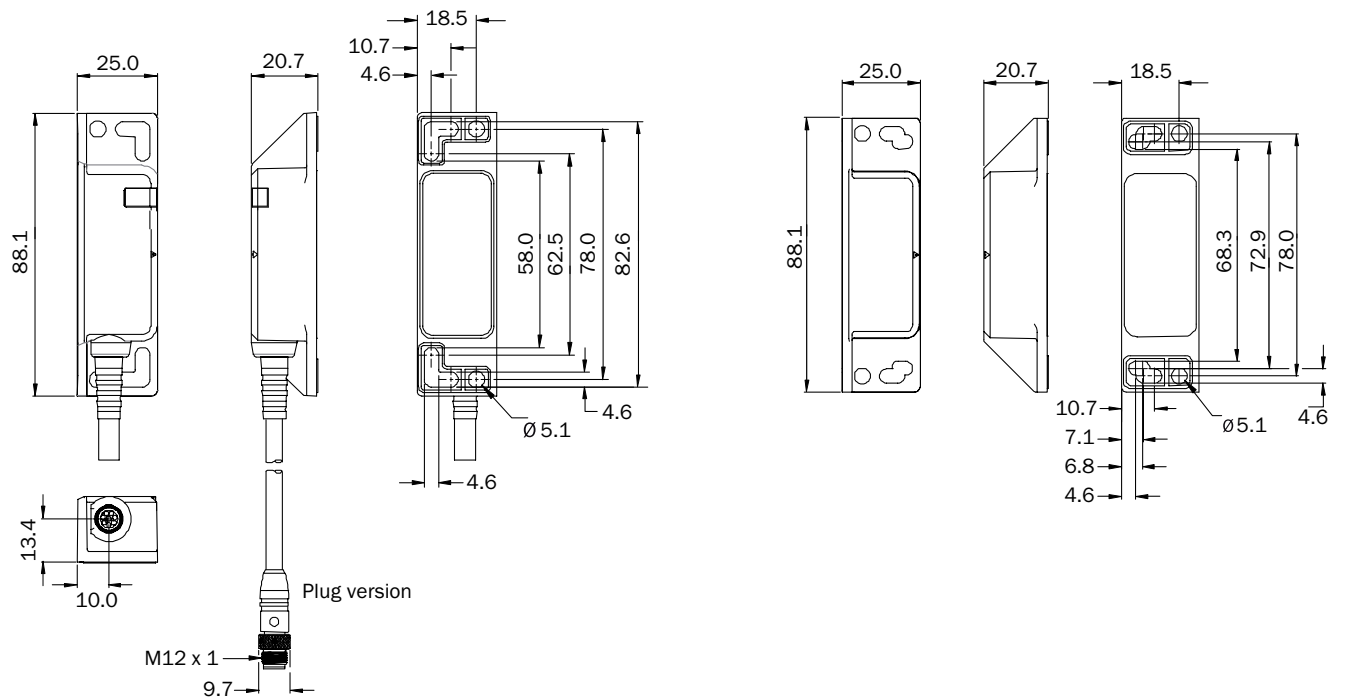

Dimensions in mm (inch)

Response range

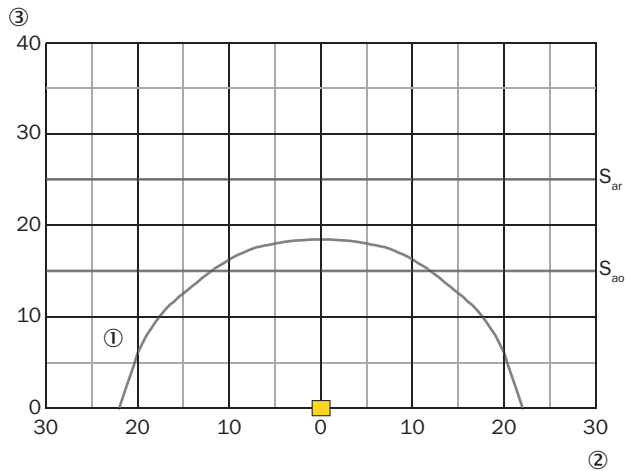

- ① Sensing range
- ② side deviation in mm
- ③ distance to sensor surface

Pinouts

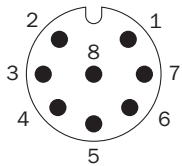

1	Aux output (not safe)
2	Voltage supply 24 V DC
3	Not connected
4	Enable input for OSSD 2
5	OSSD 1
6	OSSD 2
7	Voltage supply 0 V DC
8	Enable input for OSSD 1

Connection single sensor

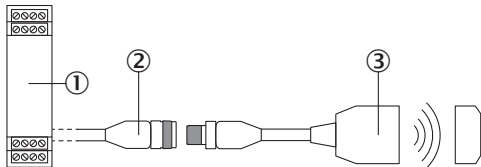

- ① Safe evaluation unit
- ② connecting cable with M12 female connector, 8-pin and flying leads (e.g. YF2A18-xxxUA5LEAX)
- ③ TR4 Direct RFID safety switch (e.g., TR4-Sxx01C)

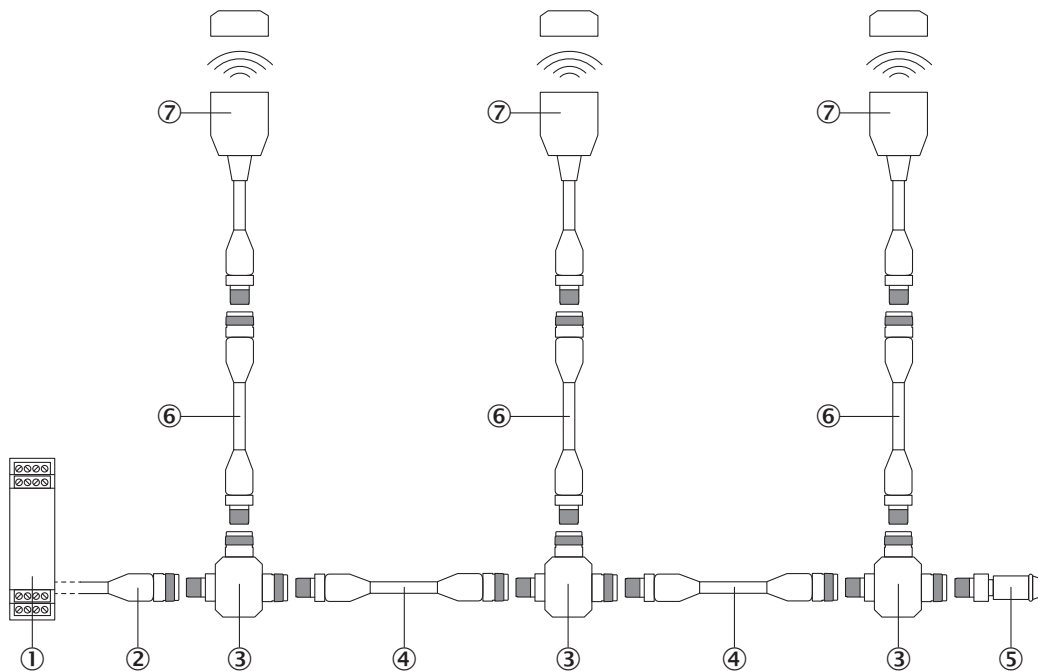

Series connection with T-piece (without diagnostics)



- ① Safe evaluation unit
- ② connecting cable with M12 female connector, 4-pin and flying leads (e.g. YF2A14-xxxVB3XLEAX)
- ③ STR1-XXA T-connector
- ④ Connection cable with 4-pin, M12 male connector and 4-pin, M12 female connector (e.g., YF2A14-xxxVB3M2A14)
- ⑤ MLP1-XXT end connector
- ⑥ Connection cable with 8-pin, M12 male connector and 8-pin, M12 female connector (e.g., YF2A18-xxxUA5M2A18)
- ⑦ TR4 Direct RFID safety switch (e.g., TR4-Sxx01C)

Recommended accessories

Other models and accessories → www.sick.com/TR4_Direct

	Brief description	Type	part no.
connectors and cables			
	<ul style="list-style-type: none"> • Connection type head A: Female connector, M12, 8-pin, straight, A-coded • Connection type head B: Flying leads • Signal type: Sensor/actuator cable • Cable: 5 m, 8-wire, PUR, halogen-free • Description: Sensor/actuator cable, unshielded • Application: Uncontaminated zones, Zones with oils and lubricants, Robot, Drag chain operation 	YF2A18-050UA5XLEAX	2095653
	<ul style="list-style-type: none"> • Connection type head A: Female connector, M12, 8-pin, straight, A-coded • Connection type head B: Flying leads • Signal type: Sensor/actuator cable • Cable: 10 m, 8-wire, PUR, halogen-free • Description: Sensor/actuator cable, unshielded • Application: Uncontaminated zones, Zones with oils and lubricants, Robot, Drag chain operation 	YF2A18-100UA5XLEAX	2095654
	<ul style="list-style-type: none"> • Connection type head A: Female connector, M12, 8-pin, straight, A-coded • Connection type head B: Flying leads • Signal type: Sensor/actuator cable • Cable: 2 m, 8-wire, PUR, halogen-free • Description: Sensor/actuator cable, unshielded • Application: Uncontaminated zones, Zones with oils and lubricants, Robot, Drag chain operation 	YF2A18-020UA5XLEAX	2095652

SICK AT A GLANCE

SICK is one of the leading manufacturers of intelligent sensors and sensor solutions for industrial applications. A unique range of products and services creates the perfect basis for controlling processes securely and efficiently, protecting individuals from accidents and preventing damage to the environment.

We have extensive experience in a wide range of industries and understand their processes and requirements. With intelligent sensors, we can deliver exactly what our customers need. In application centers in Europe, Asia and North America, system solutions are tested and optimized in accordance with customer specifications. All this makes us a reliable supplier and development partner.

Comprehensive services complete our offering: SICK LifeTime Services provide support throughout the machine life cycle and ensure safety and productivity.

For us, that is “Sensor Intelligence.”

WORLDWIDE PRESENCE:

Contacts and other locations –www.sick.com