



KTL180-MM4P41ZZZZZ

KTL180

CONTRAST SENSORS

SICK
Sensor Intelligence.



Illustration may differ



Ordering information

Type	part no.
KTL180-MM4P41ZZZZZ	6068616

Other models and accessories → www.sick.com/KTL180

Detailed technical data

Features

Special applications	-
Device type	Base unit
Display	Display
Display	LED status display / 2x 4-character digital dual displays, Set value (green indicator) and actual value (red indicator) are displayed simultaneously, display of parameters
Dimensions (W x H x D)	10.5 mm x 33.2 mm x 71.9 mm
Sensing range	0 mm ... 30 mm, Proximity system ¹⁾
Sensing distance	≤ 30 mm ²⁾
Housing design	For fiber-optic
Light source	LED, white ³⁾
Angle of dispersion	Approx. 65° ⁴⁾
Wave length	400 nm ... 750 nm
Teach-in mode	1-point teach-in, 2-point teach-in, teach-in dynamic
Delay time	Adjustable
Special features	Multi-function input, base unit for BUS mode
Delivery status	Teach-in dynamic
Parameter presettings	None
Safety-related parameters	MTTF _D 294.7 years

¹⁾ Objects to be sensed with 90% reflectivity (based on DIN 5033 white standard). Sensing range depends on fiber-optic cable.

²⁾ Depending on the optical fiber cable used.

³⁾ Average service life: 100,000 h at T_J = +25 °C.

⁴⁾ See LL3 fiber-optic data.

Electronics

Supply voltage	12 V DC ... 24 V DC ¹⁾
Ripple	≤ 10 % ²⁾
Current consumption	≥ 50 mA (at 24 V)
Switching frequency	31.2 kHz
Response time	16 μs
Jitter	8 μs
Number of switching outputs	1
Switching output	PNP
Switching mode	Light/dark switching
Output current I_{max.}	100 mA ³⁾
Input, blanking input (AT)	Blanked: U = 6.5 V ... < U _v : free-running: U < 5.5 V ⁴⁾
Input, light/dark (L/D)	Light: U < 6.5 V: dark: U = 5.5 V ... < U _v ⁴⁾
Retention time (ET)	25 ms, non-volatile memory
Time delay	None
Protection class	III
Circuit protection	U _v connections, reverse polarity protected In-/outputs short-circuit protected Interference pulse suppression Outputs overcurrent and short-circuit protected

¹⁾ ± 10%.

²⁾ May not fall below or exceed U_v tolerances.

³⁾ Total current of all Outputs.

⁴⁾ Minimum pulse 300 μs.

Mechanics

Housing material	VISTAL®
Connection type	Male connector M8, 4-pin
Weight	25 g

Ambient data

Ambient operating temperature	-25 °C ... +55 °C
Ambient temperature, storage	-40 °C ... +70 °C
Shock load	IEC 60068-2-27
Enclosure rating	IP50
UL File No.	EN 60947-5-2

Certificates

EU declaration of conformity	✓
UK declaration of conformity	✓
ACMA declaration of conformity	✓
Moroccan declaration of conformity	✓
China RoHS	✓
cULus certificate	✓
Photobiological safety (IEC EN 62471)	✓

Information according to Art. 3 of Data Act (Regulation EU 2023/2854)

✓

Classifications

ECLASS 5.0	27270906
ECLASS 5.1.4	27270906
ECLASS 6.0	27270906
ECLASS 6.2	27270906
ECLASS 7.0	27270906
ECLASS 8.0	27270906
ECLASS 8.1	27270906
ECLASS 9.0	27270906
ECLASS 10.0	27270906
ECLASS 11.0	27270906
ECLASS 12.0	27270906
ETIM 5.0	EC001820
ETIM 6.0	EC001820
ETIM 7.0	EC001820
ETIM 8.0	EC001820
UNSPSC 16.0901	39121528

Dimensional drawing Bus type

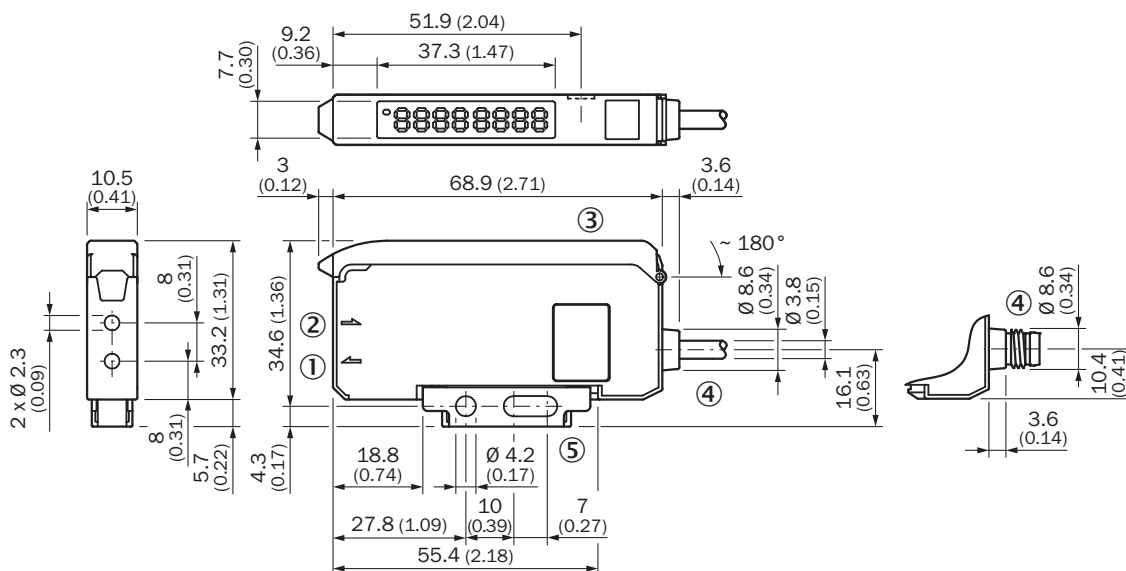

Adjustments

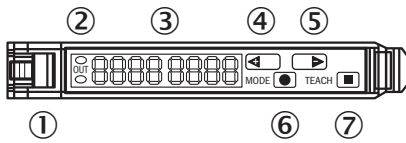

- ① Locking the fiber-optic cables
- ② LED indicator orange, lights up when switching output is active
- ③ Numeric display 2 x 4-digit; green: switching threshold, operating 2 x 4-digit; red: actual value, Teach-in and function parameter
- ④ step pushbutton > (manual switching threshold: higher/next function parameter)
- ⑤ step pushbutton < (manual switching threshold: lower/previous function parameter)
- ⑥ Mode/Enter-button
- ⑦ Teach-in button

Connection diagram Cd-380

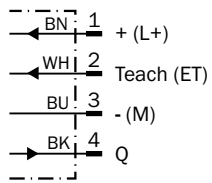

Sensing distance LL3-DB01, LL3-DB04, LL3DM02

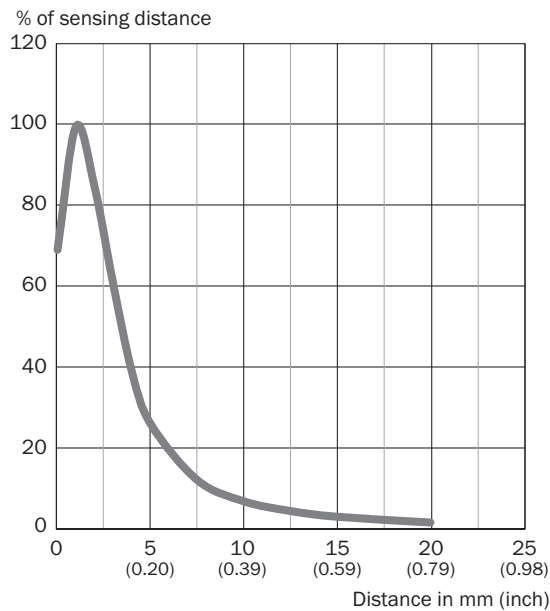

Sensing distance LL3-DB09, LL3-DK04, LL3-DY01

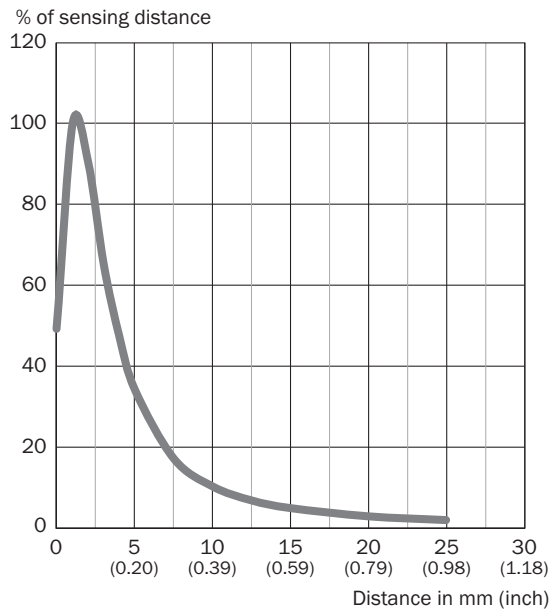

Sensing distance LL3-DC38

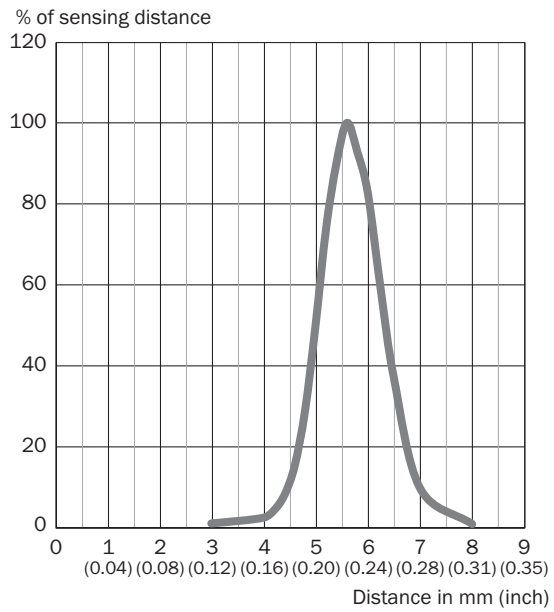

Sensing distance LL3-DM02 (LL3-DA06)

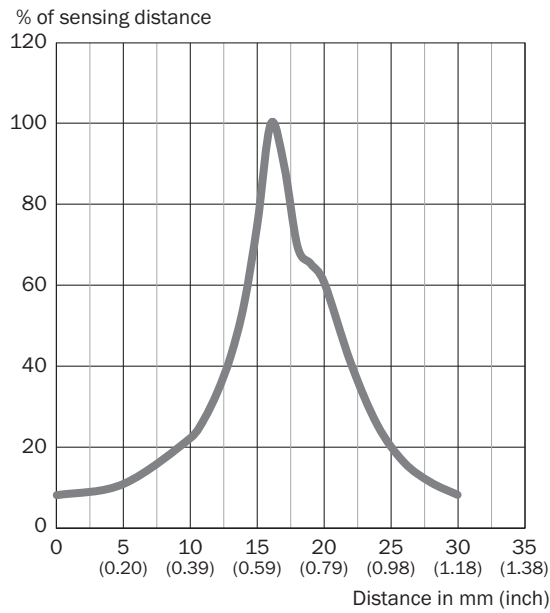

Sensing distance LL3-DM02 (LL3-DA06)

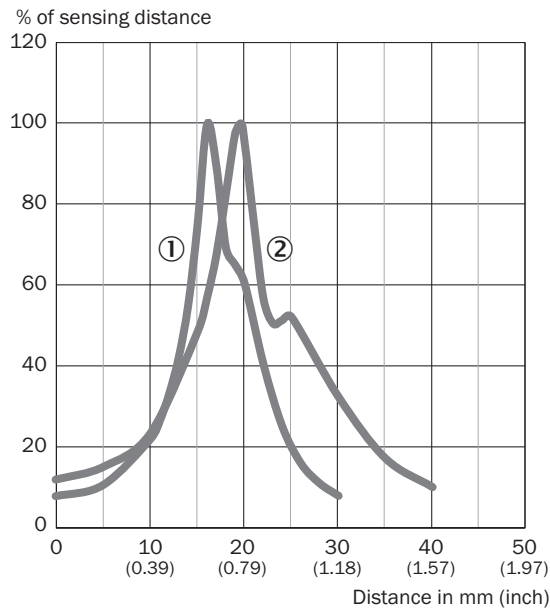

- ① thread with 3 mm distance
- ② Thread screwed flush with the nut

Sensing distance LL3-DM02 (LL3-DA09)

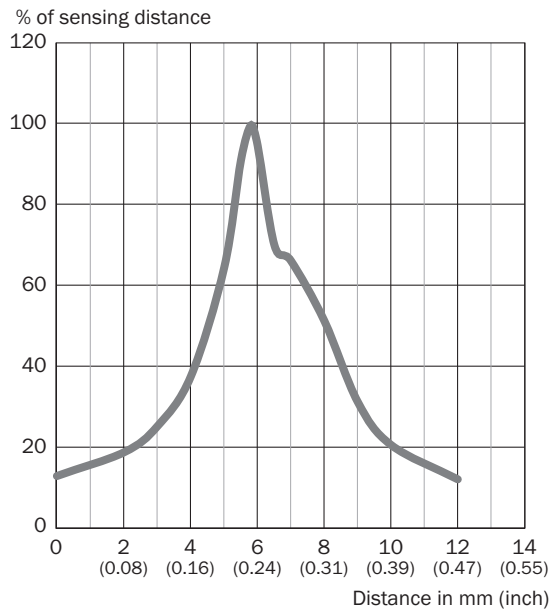

Sensing distance LL3-DC09

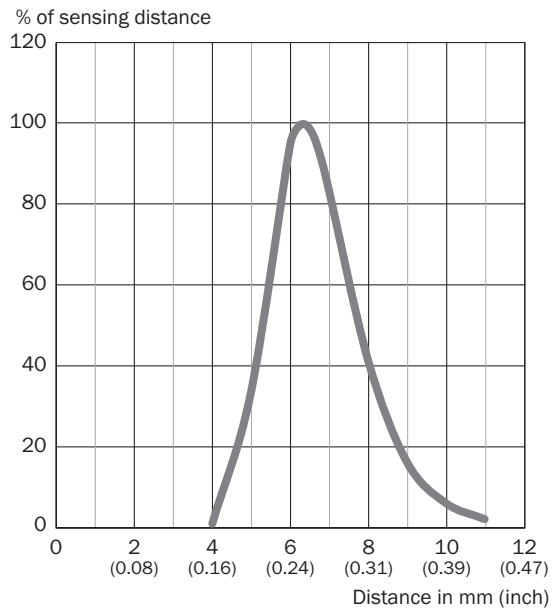

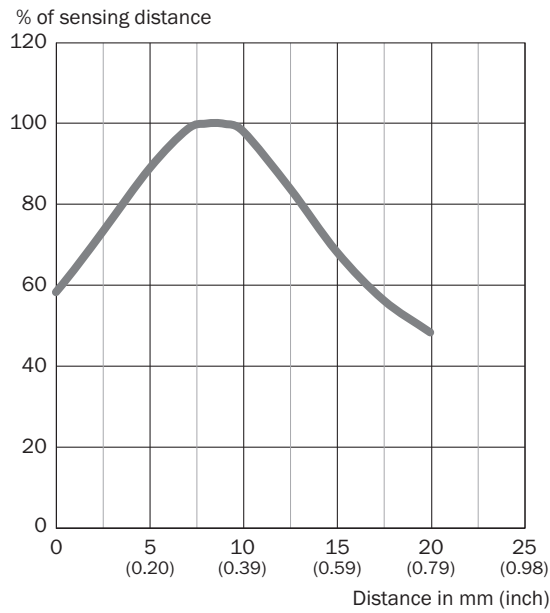

Sensing distance LL3-DZ01



Recommended accessories

Other models and accessories → www.sick.com/KTL180

	Brief description	Type	part no.
integration modules and adapters			
	<ul style="list-style-type: none"> Description: IO-Link Smart Sensor Gateway for WLL180T, KTL180 and AOD1; Features: IO-Link; COM3; M8 connection, 4-pin; full read/write functionality for the process and service data of the connected sensors. See operating instructions for additional information and technical details 	WI180C-IOA00	6071650
	<ul style="list-style-type: none"> Description: EtherCAT coupler for WLL180T, KTL180 and AOD1. Features: EtherCAT; transmission rates of up to 100 Mbaud; M12 EtherCAT connection; M8 voltage supply connection, 4-pin; full read/write functionality for the process and service data of the connected sensors. See operating instructions for additional information and technical details 	WI180C-EC	6068089
	<ul style="list-style-type: none"> Description: PROFINET coupler for WLL180T, KTL180 and AOD1. Features: PROFINET IRT; transmission rates 10 Mbaud – 100 Mbaud; M12 PROFINET connection; M8 voltage supply connection, 4-pin; full read/write functionality for the process and service data of the connected sensors. See operating instructions for additional information and technical details 	WI180C-PN	6068088

	Brief description	Type	part no.
fiber-optic sensors			
	<ul style="list-style-type: none"> • Functional principle: Proximity system • Thread diameter (housing): M4 	LL3-DA09	5334040
	<ul style="list-style-type: none"> • Functional principle: Proximity system • Thread diameter (housing): M4 	LL3-DA06	5326468
	<ul style="list-style-type: none"> • For fiber optic amplifiers: GLL70, WLL80, WLL180, GLL170(T), WLL24 Ex • Functional principle: Through-beam system • Fiber length: 2,000 mm • Fiber-optic head array width: 40 mm • Fiber material: Plastic • Jacket material: Plastic • Fiber head material: Plastic • Included with delivery: Mounting, 4 x M3 Phillips-head screw, FC fiber cutter (5304141), protective cladding for fiber head 	LL3-TS40	5323971
	<ul style="list-style-type: none"> • For fiber optic amplifiers: GLL70, WLL80, WLL180, GLL170(T), WLL24 Ex, KTL180 • Functional principle: Proximity system • Fiber length: 2,000 mm • Fiber material: Plastic • Jacket material: Plastic • Fiber head material: Plastic • Included with delivery: Adapter sleeves, BF-WLL160-10 (1.0 mm) adapter sleeves, FC fiber cutter (5304141) 	LL3-DC38	5322472
	<ul style="list-style-type: none"> • For fiber optic amplifiers: GLL70, WLL80, WLL180, GLL170(T), WLL24 Ex, KTL180 • Functional principle: Proximity system • Fiber length: 2,000 mm • Smooth sleeve diameter: 6 mm • Fiber material: Plastic • Jacket material: Chemical-resistant plastic • Fiber head material: Chemical-resistant plastic • Included with delivery: FC fiber cutter (5304141) 	LL3-DY01	5308093
	<ul style="list-style-type: none"> • For fiber optic amplifiers: GLL70, WLL80, WLL180, GLL170(T), WLL24 Ex • Functional principle: Proximity system • Fiber length: 2,000 mm • Fiber-optic head array width: 4 mm • Fiber material: Plastic • Jacket material: Plastic • Fiber head material: Plastic • Included with delivery: FC fiber cutter (5304141) 	LL3-DZ01	5326013
	<ul style="list-style-type: none"> • For fiber optic amplifiers: GLL70, WLL80, WLL180, GLL170(T), WLL24 Ex • Functional principle: Proximity system • Fiber length: 2,000 mm • Smooth sleeve diameter: 5 mm • Fiber material: Plastic • Jacket material: Plastic • Fiber head material: Stainless steel • Included with delivery: FC fiber cutter (5304141) 	LL3-DV01	5308088
	<ul style="list-style-type: none"> • For fiber optic amplifiers: GLL70, WLL80, WLL180, GLL170(T), WLL24 Ex, KTL180 • Functional principle: Proximity system • Fiber length: 2,000 mm • Fiber material: Plastic • Jacket material: Plastic • Fiber head material: Plastic • Included with delivery: Mounting, 2 x M2 hexagon nut, 4 x washer, 2 x M2 Phillips-head screw, adapter sleeves, BF-WLL160-10 (1.0 mm) adapter sleeves, FC fiber cutter (5304141) 	LL3-DC09	5326028
	<ul style="list-style-type: none"> • For fiber optic amplifiers: GLL70, WLL80, WLL180, GLL170(T), WLL24 Ex, KTL180 • Functional principle: Proximity system • Fiber length: 2,000 mm • Thread diameter (housing): M6 • Fiber material: Plastic • Jacket material: Plastic • Fiber head material: Stainless steel • Included with delivery: Mounting, 2 x M6 hexagon nut, 1 x washer, FC fiber cutter (5304141) 	LL3-DB09	5325991
	<ul style="list-style-type: none"> • For fiber optic amplifiers: GLL70, WLL80, WLL180, GLL170(T), WLL24 Ex, KTL180 • Functional principle: Proximity system • Fiber length: 2,000 mm • Smooth sleeve diameter: 3 mm • Fiber material: Plastic 	LL3-DK04	5313020

	Brief description	Type	part no.
	<ul style="list-style-type: none"> Jacket material: Plastic Fiber head material: Stainless steel Included with delivery: Adapter sleeves, BF-WLL160-13 (1.3 mm) adapter sleeves, FC fiber cutter (5304141) For fiber optic amplifiers: GLL70, WLL80, WLL180, GLL170(T), WLL24 Ex, KTL180 Functional principle: Proximity system Fiber length: 2,000 mm Thread diameter (housing): M4 Fiber material: Plastic Jacket material: Plastic Fiber head material: Stainless steel Included with delivery: Mounting, 2 x M4 hexagon nut, 2 x washer, adapter sleeves, BF-WLL160-13 (1.3 mm) adapter sleeves, FC fiber cutter (5304141) 	LL3-DM02	5308077
	<ul style="list-style-type: none"> For fiber optic amplifiers: GLL70, WLL80, WLL180, GLL170(T), KTL180 Functional principle: Proximity system Fiber length: 2,000 mm Thread diameter (housing): M6 Fiber material: Plastic Jacket material: Plastic Fiber head material: Stainless steel Included with delivery: Mounting, 2 x M6 hexagon nut, 2 x washer, FC fiber cutter (5304141) 	LL3-DB04	5325990
	<ul style="list-style-type: none"> For fiber optic amplifiers: GLL70, WLL80, WLL180, GLL170(T), WLL24 Ex, KTL180 Functional principle: Proximity system Fiber length: 2,000 mm Thread diameter (housing): M6 Fiber material: Plastic Jacket material: Plastic Fiber head material: Stainless steel Included with delivery: Mounting, 2 x M6 hexagon nut, 2 x washer, FC fiber cutter (5304141) 	LL3-DB01	5308074
Mounting systems			
	<ul style="list-style-type: none"> Description: Rail end piece for block mounting Material: Stainless steel Details: Stainless steel Items supplied: Mounting hardware included 	BEF-EB01-W190	5313011
	<ul style="list-style-type: none"> Description: Mounting bracket Material: Steel Details: Steel, zinc coated Items supplied: Without mounting hardware Usable for: Fiber-optic sensors Suitable for: WLL180T, GLL170(T) 	BEF-WLL180	5325812
	<ul style="list-style-type: none"> Description: Fiber cutter, included with delivery of selected fibers Dimensions (W x H x L): 10 mm x 37 mm x 65 mm 	FC	5304141
	<ul style="list-style-type: none"> Description: Adapter sleeve for LBS/LIS fibers with \varnothing 4.8 mm for adaptation to \varnothing 2.2 mm Items supplied: 2 pieces 	Fiber Optic Adaptor Kit	2062854
connectors and cables			
	<ul style="list-style-type: none"> Connection type head A: Male connector, M8, 4-pin, straight, A-coded Description: Unshielded Connection systems: Screw-type terminals Permitted cross-section: 0.14 mm² ... 0.5 mm² 	STE-0804-G	6037323
	<ul style="list-style-type: none"> Connection type head A: Female connector, M8, 4-pin, straight, A-coded Connection type head B: Flying leads Signal type: Sensor/actuator cable Cable: 5 m, 4-wire, PVC Description: Sensor/actuator cable, unshielded Application: Zones with chemicals, Uncontaminated zones 	YF8U14-050VA3XLEAX	2095889

SICK AT A GLANCE

SICK is one of the leading manufacturers of intelligent sensors and sensor solutions for industrial applications. A unique range of products and services creates the perfect basis for controlling processes securely and efficiently, protecting individuals from accidents and preventing damage to the environment.

We have extensive experience in a wide range of industries and understand their processes and requirements. With intelligent sensors, we can deliver exactly what our customers need. In application centers in Europe, Asia and North America, system solutions are tested and optimized in accordance with customer specifications. All this makes us a reliable supplier and development partner.

Comprehensive services complete our offering: SICK LifeTime Services provide support throughout the machine life cycle and ensure safety and productivity.

For us, that is “Sensor Intelligence.”

WORLDWIDE PRESENCE:

Contacts and other locations –www.sick.com