



TBS-1ASG10506FM

TBS

TEMPERATURE SENSORS

SICK
Sensor Intelligence.



Illustration may differ



Ordering information

Type	part no.
TBS-1ASG10506FM	6065451

Other models and accessories → www.sick.com/TBS

Detailed technical data

Features

Measuring range	-20 °C ... +80 °C
Sensor element	Pt1000, 2-wire
Output signal	2 x PNP
Maximum ohmic load R_A	≤ 100 kΩ Switching outputs
Switching output	2 x PNP
Number of switching outputs	2
Switching voltage	Supply voltage [V DC] - 1 V DC
Maximum switching current	≤ 250 mA
Switching delay	0 s ... 50 s, programmable
Setting accuracy of switching outputs	+0.1 °C
Display	14-segment LED, blue, 4-digits, height 9 mm, Display electronically turnable by 180 °, update: 200 ms
Rotatable housing	Display against housing with electrical connection: 330 °, housing against process connection: 320 °
Scaling of measuring range	Zero point: max. +25 % of span Full scale: max. -25 % of span

Mechanics/electronics

Communication interface	-
Process connection	Thread G ¼ A
Seal	FPM/FKM
Insertion length/diameter of probe	50 mm / 6 mm
Wetted parts	Stainless steel 1.4571 (AISI 316Ti)
Maximum process pressure	≤ 150 bar ¹⁾

¹⁾ At room temperature and when connected through thread.

²⁾ For configurations with 2 switching outputs or with one switching output + one analog output.

³⁾ The enclosure rating classes specified only apply while the thermometer is connected with female connectors that provide the corresponding enclosure rating.

⁴⁾ IP enclosure rating as per IEC 60529.

Housing material	Stainless steel 1.4301 (AISI 304) Lower body PC + ABS Plastic head TPE-E Input keypad PC Display window
Connection type	M12 round connector x 1, 4-pin ^{2) 3)}
Enclosure rating	IP65 ⁴⁾ IP67 ⁴⁾
Supply voltage	15 V DC ... 35 V DC
Maximum current consumption	≤ 45 mA
Total current consumption	570 mA (incl. switching current) 320 mA
Electrical safety	Protection class: III, dielectric strength: 500 V, Overvoltage protection: 40 V DC, Short-circuit protection: Q _A , Q ₁ , Q ₂ towards M, Reverse polarity protection: L ⁺ to M
CE-conformity	2004/108/EC, EN 61326-1 emission (group 1, class B) and interference immunity (industrial application)
MTTF	325 years

¹⁾ At room temperature and when connected through thread.

²⁾ For configurations with 2 switching outputs or with one switching output + one analog output.

³⁾ The enclosure rating classes specified only apply while the thermometer is connected with female connectors that provide the corresponding enclosure rating.

⁴⁾ IP enclosure rating as per IEC 60529.

Performance

Accuracy of sensor element	Class A according to IEC 60751 ^{1) 2)}
Accuracy of switching output	≤ ± 0.8 % of span
Display accuracy	≤ ± 0.8 % of span ± 1 digit
Response time	t ₅₀ ≤ 5 s ³⁾ t ₉₀ ≤ 10 s ³⁾

¹⁾ $\leq \pm (0.15 \text{ °C} + 0.002 |t|)$.

²⁾ |t| is the absolute value of the temperature in °C.

³⁾ Depending on sensor configuration, according to IEC 60751.

Ambient data

Ambient temperature	-20 °C ... +80 °C
Storage and transport temperature	-20 °C ... +80 °C
Relative humidity	45 % ... 75 %

Certificates

EU declaration of conformity	✓
UK declaration of conformity	✓
China RoHS	✓
cULus certificate	✓

Classifications

ECLASS 5.0	27200208
ECLASS 5.1.4	27200208
ECLASS 6.0	27200208
ECLASS 6.2	27200208

ECLASS 7.0	27200208
ECLASS 8.0	27200208
ECLASS 8.1	27200208
ECLASS 9.0	27200208
ECLASS 10.0	27200208
ECLASS 11.0	27200208
ECLASS 12.0	27200208
ETIM 5.0	EC002994
ETIM 6.0	EC002994
ETIM 7.0	EC002994
ETIM 8.0	EC002994
UNSPSC 16.0901	41112211

Dimensional drawing TBS with connection G 1/4 A according to DIN 3852-E

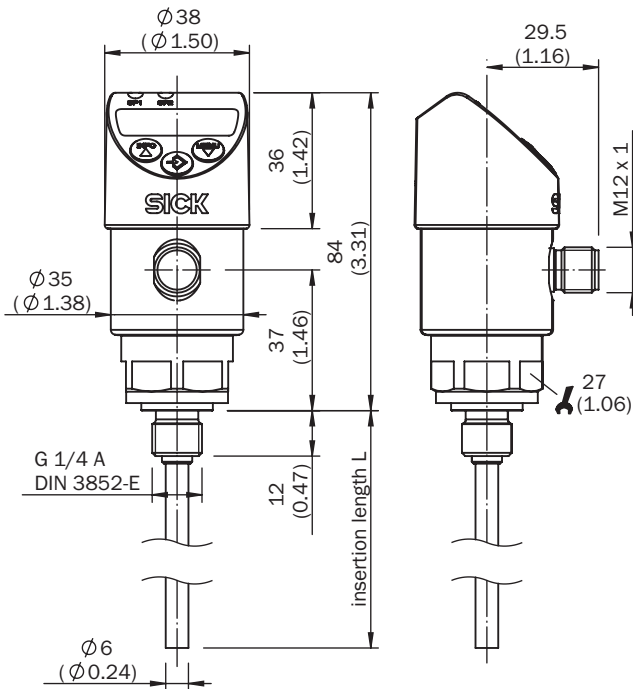

Dimensions in mm (inch)

Connection type









- ① L+
- ② Q_A/Q₂, type-dependent
- ③ M

④ Q₁

Recommended accessories

Other models and accessories → www.sick.com/TBS

	Brief description	Type	part no.
connectors and cables			
	<ul style="list-style-type: none"> • Connection type head A: Female connector, M12, 4-pin, straight, A-coded • Connection type head B: Flying leads • Signal type: Sensor/actuator cable • Cable: 2 m, 4-wire, PUR, halogen-free • Description: Sensor/actuator cable, unshielded • Application: Uncontaminated zones, Zones with oils and lubricants, Robot, Drag chain operation 	YF2A14-020UB3XLEAX	2095607
	<ul style="list-style-type: none"> • Connection type head A: Female connector, M12, 4-pin, straight, A-coded • Connection type head B: Flying leads • Signal type: Sensor/actuator cable • Cable: 5 m, 4-wire, PUR, halogen-free • Description: Sensor/actuator cable, unshielded • Application: Uncontaminated zones, Zones with oils and lubricants, Robot, Drag chain operation 	YF2A14-050UB3XLEAX	2095608
	<ul style="list-style-type: none"> • Connection type head A: Female connector, M12, 4-pin, straight, A-coded • Connection type head B: Flying leads • Signal type: Sensor/actuator cable • Cable: 2 m, 4-wire, PVC • Description: Sensor/actuator cable, unshielded • Application: Zones with chemicals, Uncontaminated zones 	YF2A14-020VB3XLEAX	2096234
	<ul style="list-style-type: none"> • Connection type head A: Female connector, M12, 4-pin, straight, A-coded • Connection type head B: Flying leads • Signal type: Sensor/actuator cable • Cable: 5 m, 4-wire, PVC • Description: Sensor/actuator cable, unshielded • Application: Zones with chemicals, Uncontaminated zones 	YF2A14-050VB3XLEAX	2096235
	<ul style="list-style-type: none"> • Connection type head A: Female connector, M12, 4-pin, straight, A-coded • Connection type head B: Flying leads • Signal type: Sensor/actuator cable • Cable: 0.6 m, 4-wire, PUR, halogen-free • Description: Sensor/actuator cable, unshielded • Application: Uncontaminated zones, Zones with oils and lubricants, Robot, Drag chain operation 	YF2A14-C60UB3XLEAX	2145654
	<ul style="list-style-type: none"> • Connection type head A: Female connector, M12, 4-pin, straight, A-coded • Connection type head B: Flying leads • Signal type: Sensor/actuator cable • Cable: 1 m, 4-wire, PUR, halogen-free • Description: Sensor/actuator cable, unshielded • Application: Uncontaminated zones, Zones with oils and lubricants, Robot, Drag chain operation 	YF2A14-010UB3XLEAX	2145655
	<ul style="list-style-type: none"> • Connection type head A: Female connector, M12, 4-pin, straight, A-coded • Connection type head B: Flying leads • Signal type: Sensor/actuator cable • Cable: 3 m, 4-wire, PUR, halogen-free • Description: Sensor/actuator cable, unshielded • Application: Uncontaminated zones, Zones with oils and lubricants, Robot, Drag chain operation 	YF2A14-030UB3XLEAX	2145656
	<ul style="list-style-type: none"> • Connection type head A: Female connector, M12, 4-pin, straight, A-coded • Connection type head B: Flying leads • Signal type: Sensor/actuator cable • Cable: 0.6 m, 4-wire, PVC • Description: Sensor/actuator cable, unshielded • Application: Zones with chemicals, Uncontaminated zones 	YF2A14-C60VB3XLEAX	2145707
	<ul style="list-style-type: none"> • Connection type head A: Female connector, M12, 4-pin, straight, A-coded • Connection type head B: Flying leads • Signal type: Sensor/actuator cable • Cable: 1 m, 4-wire, PVC • Description: Sensor/actuator cable, unshielded • Application: Zones with chemicals, Uncontaminated zones 	YF2A14-010VB3XLEAX	2145708

SICK AT A GLANCE

SICK is one of the leading manufacturers of intelligent sensors and sensor solutions for industrial applications. A unique range of products and services creates the perfect basis for controlling processes securely and efficiently, protecting individuals from accidents and preventing damage to the environment.

We have extensive experience in a wide range of industries and understand their processes and requirements. With intelligent sensors, we can deliver exactly what our customers need. In application centers in Europe, Asia and North America, system solutions are tested and optimized in accordance with customer specifications. All this makes us a reliable supplier and development partner.

Comprehensive services complete our offering: SICK LifeTime Services provide support throughout the machine life cycle and ensure safety and productivity.

For us, that is “Sensor Intelligence.”

WORLDWIDE PRESENCE:

Contacts and other locations –www.sick.com