



# WL100-2P1332S08

W100-2

PHOTOELECTRIC SENSORS

**SICK**  
Sensor Intelligence.



Illustration may differ



### Ordering information

Type	part no.
WL100-2P1332S08	6058893

Other models and accessories → [www.sick.com/W100-2](http://www.sick.com/W100-2)

### Detailed technical data

#### Features

<b>Functional principle</b>	Photoelectric retro-reflective sensor
<b>Functional principle detail</b>	With minimum distance to reflector (dual lens system)
<b>Dimensions (W x H x D)</b>	11 mm x 31 mm x 20 mm
<b>Housing design (light emission)</b>	Rectangular
<b>Sensing range max.</b>	0.01 m ... 7.2 m <sup>1)</sup>
<b>Sensing range</b>	0.01 m ... 5.5 m <sup>1)</sup>
<b>Type of light</b>	Visible red light
<b>Light source</b>	LED <sup>2)</sup>
<b>Light spot size (distance)</b>	Ø 280 mm (4 m)
<b>Wave length</b>	632 nm
<b>Adjustment</b>	None

<sup>1)</sup> Reflector PL80A.

<sup>2)</sup> Average service life: 100,000 h at T<sub>J</sub> = +25 °C.

#### Mechanics/electronics

<b>Supply voltage U<sub>B</sub></b>	10 V DC ... 30 V DC <sup>1)</sup>
<b>Ripple</b>	± 10 % <sup>2)</sup>

<sup>1)</sup> Limit values.

<sup>2)</sup> May not fall below or exceed U<sub>V</sub> tolerances.

<sup>3)</sup> Without load.

<sup>4)</sup> Signal transit time with resistive load.

<sup>5)</sup> With light/dark ratio 1:1.

<sup>6)</sup> Do not bend below 0 °C.

<sup>7)</sup> A = V<sub>S</sub> connections reverse-polarity protected.

<sup>8)</sup> B = output reverse-polarity protected.

<sup>9)</sup> D = outputs overcurrent and short-circuit protected.

<b>Current consumption</b>	30 mA <sup>3)</sup>
<b>Switching output</b>	PNP
<b>Switching mode</b>	Light switching
<b>Signal voltage PNP HIGH/LOW</b>	$U_V - 1,8 \text{ V} / \text{ca. } 0 \text{ V}$
<b>Output current <math>I_{\text{max}}</math></b>	$\leq 100 \text{ mA}$
<b>Response time</b>	$\leq 0,5 \text{ ms}^4)$
<b>Switching frequency</b>	1,000 Hz <sup>5)</sup>
<b>Connection type</b>	Cable, 3-wire, 5 m <sup>6)</sup>
<b>Cable material</b>	Plastic, PVC
<b>Conductor cross section</b>	0.18 mm <sup>2</sup>
<b>Circuit protection</b>	A <sup>7)</sup> B <sup>8)</sup> D <sup>9)</sup>
<b>Protection class</b>	III
<b>Polarisation filter</b>	✓
<b>Housing material</b>	Plastic, ABS/PC/POM
<b>Optics material</b>	Plastic, PMMA
<b>Enclosure rating</b>	IP67
<b>Ambient operating temperature</b>	-25 °C ... +55 °C
<b>Ambient temperature, storage</b>	-40 °C ... +70 °C

1) Limit values.

2) May not fall below or exceed  $U_V$  tolerances.

3) Without load.

4) Signal transit time with resistive load.

5) With light/dark ratio 1:1.

6) Do not bend below 0 °C.

7) A =  $V_S$  connections reverse-polarity protected.

8) B = output reverse-polarity protected.

9) D = outputs overcurrent and short-circuit protected.

### Safety-related parameters

<b>MTTF<sub>D</sub></b>	954 years
<b>DC<sub>avg</sub></b>	0 %

### Certificates

<b>EU declaration of conformity</b>	✓
<b>UK declaration of conformity</b>	✓
<b>ACMA declaration of conformity</b>	✓
<b>Moroccan declaration of conformity</b>	✓
<b>China RoHS</b>	✓
<b>Photobiological safety (DIN EN 62471) certificate</b>	✓

### Classifications

<b>ECLASS 5.0</b>	27270902
<b>ECLASS 5.1.4</b>	27270902

<b>ECLASS 6.0</b>	27270902
<b>ECLASS 6.2</b>	27270902
<b>ECLASS 7.0</b>	27270902
<b>ECLASS 8.0</b>	27270902
<b>ECLASS 8.1</b>	27270902
<b>ECLASS 9.0</b>	27270902
<b>ECLASS 10.0</b>	27270902
<b>ECLASS 11.0</b>	27270902
<b>ECLASS 12.0</b>	27270902
<b>ETIM 5.0</b>	EC002717
<b>ETIM 6.0</b>	EC002717
<b>ETIM 7.0</b>	EC002717
<b>ETIM 8.0</b>	EC002717
<b>UNSPSC 16.0901</b>	39121528

### Adjustments

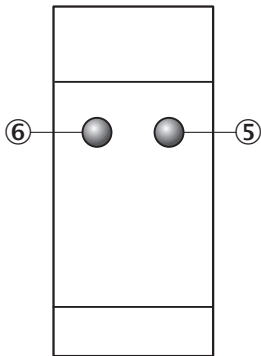

- ⑤ LED indicator orange: output active
- ⑥ LED indicator green: stability indicator

### Adjustments W100-2

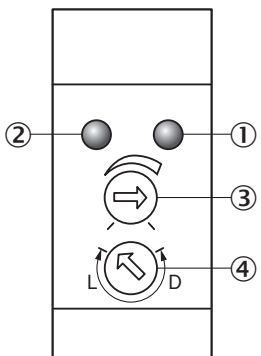

- ① LED indicator orange: switching output active
- ② LED indicator green: power on
- ③ Sensing range adjustment: potentiometer

④ Light/ dark rotary switch: L = light switching, D = dark switching

**Connection diagram Cd-043**

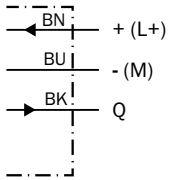

**Characteristic curve WL100-2**

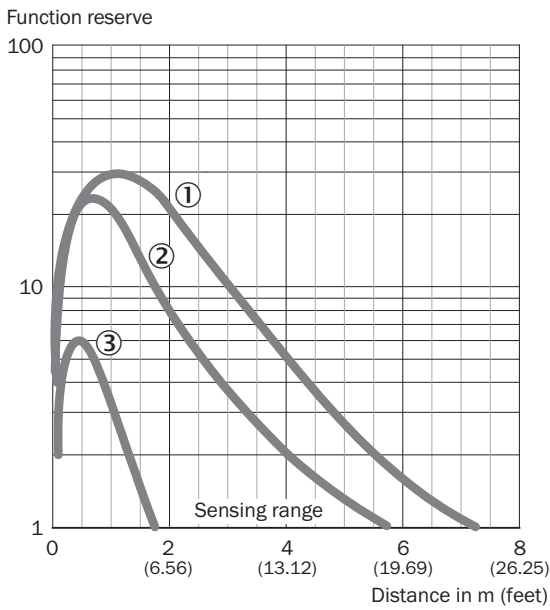

- ① Reflector PL80A
- ② Reflector P250
- ③ Diamond Grade reflective tape, 100 mm x 100 mm

**Light spot size**

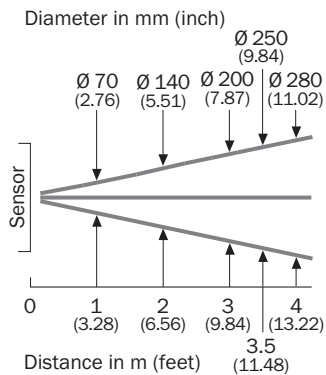

### Sensing range diagram WL100-2

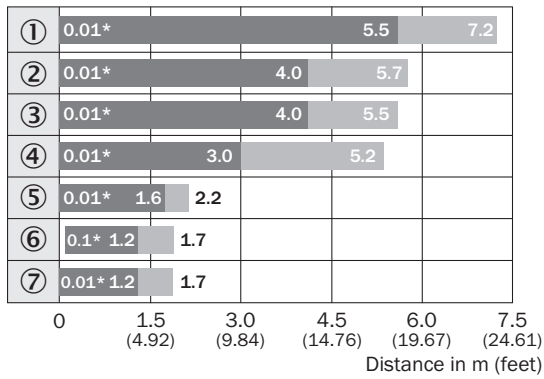

■ Sensing range      ■ Sensing range max.

\*Close-up range at maximum sensitivity

- ① Reflector PL80A
- ② Reflector P250
- ③ Reflector PL50A, PL40A
- ④ Reflector PL30A, PL31A
- ⑤ Reflector PL20A
- ⑥ Reflective tape Diamond Grade
- ⑦ P45

### Dimensional drawing

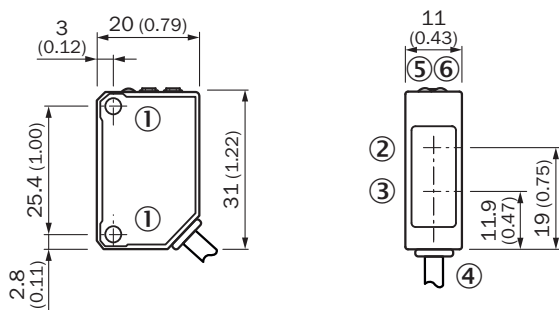





Dimensions in mm (inch)

- ① Threaded mounting hole M3
- ② Center of optical axis, receiver
- ③ Center of optical axis, sender
- ④ Connection
- ⑤ LED indicator orange: switching output active
- ⑥ LED indicator green: power on

Recommended accessories

Other models and accessories → [www.sick.com/W100-2](http://www.sick.com/W100-2)

	Brief description	Type	part no.
connectors and cables			
	<ul style="list-style-type: none"> <li>• <b>Connection type head A:</b> Male connector, M8, 3-pin, straight, A-coded</li> <li>• <b>Description:</b> Unshielded</li> <li>• <b>Connection systems:</b> Screw-type terminals</li> <li>• <b>Permitted cross-section:</b> 0.14 mm<sup>2</sup> ... 0.5 mm<sup>2</sup></li> </ul>	STE-0803-G	6037322
Mounting systems			
	<ul style="list-style-type: none"> <li>• <b>Description:</b> Mounting bracket for wall mounting</li> <li>• <b>Material:</b> Stainless steel</li> <li>• <b>Details:</b> Stainless steel</li> <li>• <b>Items supplied:</b> Mounting hardware included</li> <li>• <b>Suitable for:</b> W8, W8G, W8 Laser, W8 Inox, G6, G6 Inox, W100 Laser, W100-2, KTM Core, KTM Prime, CSM, LUTM, W4S</li> </ul>	BEF-W100-A	5311520
	<ul style="list-style-type: none"> <li>• <b>Description:</b> Mounting bracket for floor mounting</li> <li>• <b>Material:</b> Steel</li> <li>• <b>Details:</b> Steel, zinc coated</li> <li>• <b>Items supplied:</b> Mounting hardware included</li> <li>• <b>Suitable for:</b> W8, W8G, W8 Laser, W8 Inox, G6, G6 Inox, W100 Laser, W100-2, KTM Core, KTM Prime, CSM, LUTM</li> </ul>	BEF-W100-B	5311521
	<ul style="list-style-type: none"> <li>• <b>Description:</b> Universal mounting bracket for reflectors</li> <li>• <b>Dimensions (W x H x L):</b> 85 mm x 90 mm x 35 mm</li> <li>• <b>Material:</b> Steel</li> <li>• <b>Details:</b> Steel, zinc coated</li> <li>• <b>Suitable for:</b> C110A, P250, PL20, PL30A, PL40A, PL80A</li> </ul>	BEF-WN-REFX	2064574
reflectors and optics			
	<ul style="list-style-type: none"> <li>• <b>Description:</b> Rectangular, screw connection</li> <li>• <b>Dimensions:</b> 51 mm 61 mm</li> <li>• <b>Ambient operating temperature:</b> -30 °C ... +65 °C</li> </ul>	P250	5304812

## SICK AT A GLANCE

SICK is one of the leading manufacturers of intelligent sensors and sensor solutions for industrial applications. A unique range of products and services creates the perfect basis for controlling processes securely and efficiently, protecting individuals from accidents and preventing damage to the environment.

We have extensive experience in a wide range of industries and understand their processes and requirements. With intelligent sensors, we can deliver exactly what our customers need. In application centers in Europe, Asia and North America, system solutions are tested and optimized in accordance with customer specifications. All this makes us a reliable supplier and development partner.

Comprehensive services complete our offering: SICK LifeTime Services provide support throughout the machine life cycle and ensure safety and productivity.

For us, that is “Sensor Intelligence.”

## WORLDWIDE PRESENCE:

Contacts and other locations –[www.sick.com](http://www.sick.com)