



CM18-08BPP-EC1

CM

CAPACITIVE PROXIMITY SENSORS

SICK
Sensor Intelligence.



Ordering information

Type	part no.
CM18-08BPP-EC1	6058145

Other models and accessories → www.sick.com/CM

Illustration may differ



Detailed technical data

Features

Housing	Metric
Thread size	M18 x 1
Diameter	Ø 18 mm
Sensing range S_n	0 mm ... 8 mm
Safe sensing range S_a	6.12 mm ¹⁾
Installation type	Flush
Switching frequency	50 Hz
Connection type	Male connector M12, 4-pin
Switching output	PNP
Switching output detail	PNP
Output function	Complementary
Output characteristic	Wire configurable
Electrical wiring	DC 4-wire
Adjustment	
	Potentiometer Sensitivity (11 turns)
Enclosure rating	IP67 IP68 ²⁾ IP69K
Items supplied	Mounting nut, PA12 plastic (2x) Screwdriver for potentiometer adjustment (1 x)

¹⁾ For flush mounting in electrically conductive materials S_a = 0.8 x S_r at temperatures <0 °C and >60 °C.

²⁾ 1 m water depth / 60 min.

Mechanics/electronics

Supply voltage	10 V DC ... 36 V DC
Ripple	≤ 10 % ¹⁾
Voltage drop	≤ 2.5 V DC ²⁾
Current consumption	12 mA ³⁾
Time delay before availability	≤ 200 ms
Hysteresis	3 % ... 20 %
Reproducibility	≤ 5 % ⁴⁾ ⁵⁾
Temperature drift (of S_r)	± 10 %
EMC	According to EN 60947-5-2
Continuous current I_a	≤ 200 mA
Short-circuit protection	✓
Power-up pulse protection	✓
Shock and vibration resistance	According to EN 60068
Ambient operating temperature	-30 °C ... +85 °C ⁶⁾
Ambient temperature, storage	-40 °C ... +85 °C
Housing material	Plastic, PBT
Housing length	85 mm
Thread length	55 mm
Tightening torque, max.	≤ 2.6 Nm
UL File No.	NRKH.E191603

¹⁾ Of U_B.

²⁾ At I_a max.

³⁾ Without load.

⁴⁾ Of S_r.

⁵⁾ Supply voltage U_B and constant ambient temperature T_a.

⁶⁾ +120 °C short time, at the front of the sensor.

Safety-related parameters

MTTF_D	919 years
DC_{avg}	0 %
T_M (mission time)	20 years

Reduction factors

Note	The values are reference values which may vary
Metal	1
Water	1
PVC	Approx. 0.4
Oil	Approx. 0.25
Glass	0.6
Ceramics	0.5
Alcohol	0.7

Wood	0.2 ... 0.7
-------------	-------------

Installation note

Remark	Associated graphic see "Installation"
B	18 mm
C	18 mm
D	24 mm
F	24 mm

Certificates

EU declaration of conformity	✓
UK declaration of conformity	✓
Moroccan declaration of conformity	✓
China RoHS	✓
cULus certificate	✓

Classifications

ECLASS 5.0	27270102
ECLASS 5.1.4	27270102
ECLASS 6.0	27270102
ECLASS 6.2	27270102
ECLASS 7.0	27270102
ECLASS 8.0	27270102
ECLASS 8.1	27270102
ECLASS 9.0	27270102
ECLASS 10.0	27270102
ECLASS 11.0	27270102
ECLASS 12.0	27274201
ETIM 5.0	EC002715
ETIM 6.0	EC002715
ETIM 7.0	EC002715
ETIM 8.0	EC002715
UNSPSC 16.0901	39122230

Installation note Flush installation

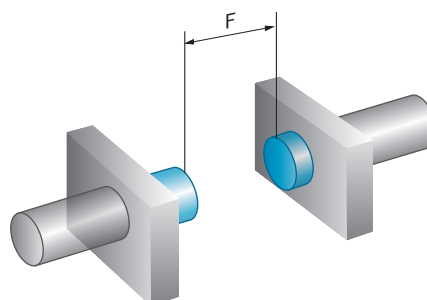
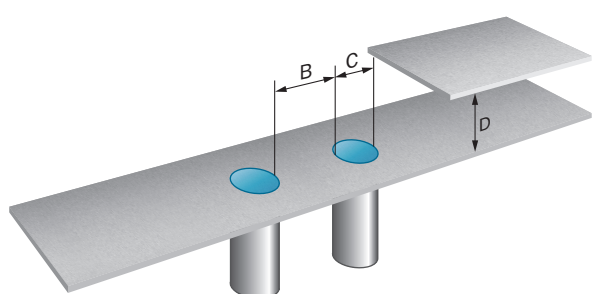

Shock and vibration resistance

Shock (IEC 60068-2-27):	30 G / 11ms, 3 pos, 3 neg per axis
Rough handling shocks (IEC 60068-2-31):	2 times from 1m, 100 times from 0,5m
Vibration (IEC 60068-2-6):	10 to 150 Hz, 1 mm / 15 G

Electromagnetic compatibility (EMC)

Electrostatic discharge (EN61000-4-2):	Contact discharge > 40 kV Air discharge > 40 kV
Electrical fast transients/burst (EN 61000-4-4):	+/- 4 kV
Surge (EN 61000-4-5):	Power supply > 2 kV (with 500 Ohm) Sensor output > 2 kV (with 500 Ohm)
Wire conducted disturbances (EN 61000-4-6):	> 20 Vrms
Power-frequency magnetic fields (EN 61000-4-8):	Continuous > 60 A/m, 75.9 μ tesla Short-time > 600 A/m, 759 μ tesla
Radiated RF electromagnetic fields (EN 61000-4-3):	> 20 V/m

Connection diagram Cd-006

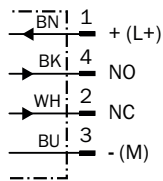

Response diagram CM18, Flush installation

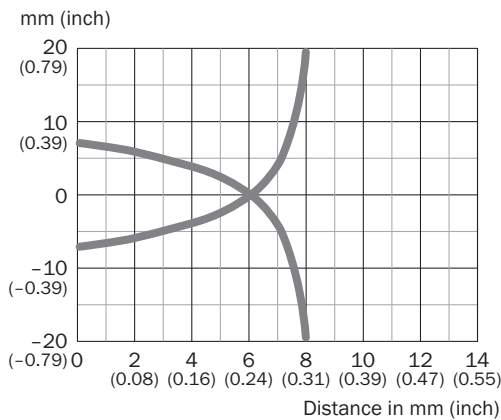

Dimensional drawing CM18, flush, connector

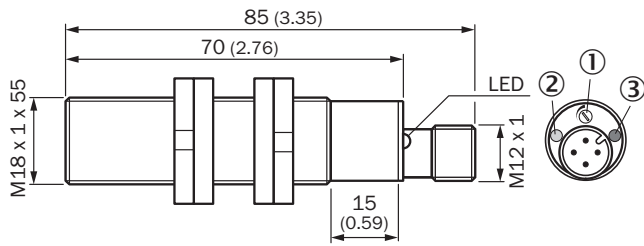







Dimensions in mm (inch)

- ① Potentiometer for sensitivity adjustment
- ② LED yellow: output active
- ③ LED green: operating indicator

Recommended accessories

Other models and accessories → www.sick.com/CM

	Brief description	Type	part no.
Mounting systems			
	<ul style="list-style-type: none"> • Description: Clamping block for round sensors M18, with fixed stop • Material: Plastic • Details: Plastic (PA12), glass-fiber reinforced • Items supplied: Mounting hardware included • Suitable for: GR18, MH15V, V180-2, V18 	BEF-KHF-M18	2051482
	<ul style="list-style-type: none"> • Description: Clamping block for round sensors M18, without fixed stop • Material: Plastic • Details: Plastic (PA12), glass-fiber reinforced • Items supplied: Mounting hardware included • Suitable for: GR18, MH15V, V180-2, V18 	BEF-KH-M18	2051481
	<ul style="list-style-type: none"> • Description: Plate N06 for universal clamp bracket, M18 • Material: Steel, zinc diecast • Details: Zinc plated steel (sheet), Zinc die cast (clamping bracket) • Items supplied: Universal clamp (5322626), mounting hardware • Usable for: MH15, MH15V, V180-2, V18V, W15, GR18, V18, V18 Laser, V12-2, SimpleSense, SureSense, M18 round sensors 	BEF-KHS-N06	2051612
	<ul style="list-style-type: none"> • Description: Plate N06N for universal clamp bracket, M18 • Material: Stainless steel, stainless steel • Details: Stainless steel 1.4571 (sheet), Stainless steel 1.4408 (clamp) • Items supplied: Universal clamp (5322627), mounting hardware • Usable for: MH15, MH15V, V180-2, V18V, W15, GR18, V18, V18 Laser, V12-2, SimpleSense, SureSense, M18 round sensors 	BEF-KHS-N06N	2051622
	<ul style="list-style-type: none"> • Description: Mounting plate for M18 sensors • Material: Steel • Details: Steel, zinc coated • Items supplied: Without mounting hardware • Suitable for: GR18, V180-2, V18, W15, Z1, Z2 	BEF-WG-M18	5321870
	<ul style="list-style-type: none"> • Description: Mounting bracket for M18 sensors • Material: Steel • Details: Steel, zinc coated • Items supplied: Without mounting hardware • Suitable for: GR18, V180-2, V18, W15, Z1, Z2 	BEF-WN-M18	5308446

	Brief description	Type	part no.
connectors and cables			
	<ul style="list-style-type: none"> • Connection type head A: Female connector, M12, 4-pin, straight, A-coded • Description: Unshielded • Connection systems: Screw-type terminals • Permitted cross-section: ≤ 0.75 mm² 	DOS-1204-G	6007302
	<ul style="list-style-type: none"> • Connection type head A: Female connector, M12, 4-pin, angled, A-coded • Description: Unshielded • Connection systems: Screw-type terminals • Permitted cross-section: ≤ 0.75 mm² 	DOS-1204-W	6007303
	<ul style="list-style-type: none"> • Connection type head A: Female connector, M12, 4-pin, straight, A-coded • Connection type head B: Flying leads • Signal type: Sensor/actuator cable • Cable: 0.6 m, 4-wire, PUR, halogen-free • Description: Sensor/actuator cable, unshielded • Application: Uncontaminated zones, Zones with oils and lubricants, Robot, Drag chain operation 	YF2A14-C60UB3XLEAX	2145654
	<ul style="list-style-type: none"> • Connection type head A: Female connector, M12, 4-pin, straight, A-coded • Connection type head B: Flying leads • Signal type: Sensor/actuator cable • Cable: 1 m, 4-wire, PUR, halogen-free • Description: Sensor/actuator cable, unshielded • Application: Uncontaminated zones, Zones with oils and lubricants, Robot, Drag chain operation 	YF2A14-010UB3XLEAX	2145655
	<ul style="list-style-type: none"> • Connection type head A: Female connector, M12, 4-pin, straight, A-coded • Connection type head B: Flying leads • Signal type: Sensor/actuator cable • Cable: 3 m, 4-wire, PUR, halogen-free • Description: Sensor/actuator cable, unshielded • Application: Uncontaminated zones, Zones with oils and lubricants, Robot, Drag chain operation 	YF2A14-030UB3XLEAX	2145656
	<ul style="list-style-type: none"> • Connection type head A: Female connector, M12, 4-pin, angled, A-coded • Connection type head B: Flying leads • Signal type: Sensor/actuator cable • Cable: 0.6 m, 4-wire, PUR, halogen-free • Description: Sensor/actuator cable, unshielded • Application: Uncontaminated zones, Zones with oils and lubricants, Robot, Drag chain operation 	YG2A14-C60UB3XLEAX	2145657
	<ul style="list-style-type: none"> • Connection type head A: Female connector, M12, 4-pin, angled, A-coded • Connection type head B: Flying leads • Signal type: Sensor/actuator cable • Cable: 1 m, 4-wire, PUR, halogen-free • Description: Sensor/actuator cable, unshielded • Application: Uncontaminated zones, Zones with oils and lubricants, Robot, Drag chain operation 	YG2A14-010UB3XLEAX	2145658
	<ul style="list-style-type: none"> • Connection type head A: Female connector, M12, 4-pin, angled, A-coded • Connection type head B: Flying leads • Signal type: Sensor/actuator cable • Cable: 0.6 m, 4-wire, PVC • Description: Sensor/actuator cable, unshielded • Application: Zones with chemicals, Uncontaminated zones 	YG2A14-C60VB3XLEAX	2145709
	<ul style="list-style-type: none"> • Connection type head A: Female connector, M12, 4-pin, angled, A-coded • Connection type head B: Flying leads • Signal type: Sensor/actuator cable • Cable: 1 m, 4-wire, PVC • Description: Sensor/actuator cable, unshielded • Application: Zones with chemicals, Uncontaminated zones 	YG2A14-010VB3XLEAX	2145710
	<ul style="list-style-type: none"> • Connection type head A: Female connector, M12, 4-pin, straight, A-coded • Connection type head B: Flying leads • Signal type: Sensor/actuator cable • Cable: 0.6 m, 4-wire, PVC • Description: Sensor/actuator cable, unshielded • Application: Zones with chemicals, Uncontaminated zones 	YF2A14-C60VB3XLEAX	2145707
	<ul style="list-style-type: none"> • Connection type head A: Female connector, M12, 4-pin, straight, A-coded • Connection type head B: Flying leads • Signal type: Sensor/actuator cable • Cable: 1 m, 4-wire, PVC • Description: Sensor/actuator cable, unshielded • Application: Zones with chemicals, Uncontaminated zones 	YF2A14-010VB3XLEAX	2145708

SICK AT A GLANCE

SICK is one of the leading manufacturers of intelligent sensors and sensor solutions for industrial applications. A unique range of products and services creates the perfect basis for controlling processes securely and efficiently, protecting individuals from accidents and preventing damage to the environment.

We have extensive experience in a wide range of industries and understand their processes and requirements. With intelligent sensors, we can deliver exactly what our customers need. In application centers in Europe, Asia and North America, system solutions are tested and optimized in accordance with customer specifications. All this makes us a reliable supplier and development partner.

Comprehensive services complete our offering: SICK LifeTime Services provide support throughout the machine life cycle and ensure safety and productivity.

For us, that is “Sensor Intelligence.”

WORLDWIDE PRESENCE:

Contacts and other locations –www.sick.com