



OD1-B035H15A15

OD Mini

DISPLACEMENT SENSORS

SICK
Sensor Intelligence.



Ordering information

Type	part no.
OD1-B035H15A15	6054083

Other models and accessories → www.sick.com/OD_Mini



Detailed technical data

Features

Measuring range	20 mm ... 50 mm
Repeatability	6 μm ^{1) 2)}
Linearity	± 30 μm ³⁾
Response time	≥ 2 ms ⁴⁾
Measuring frequency	≤ 2 kHz
Output time	≥ 0.5 ms
Emitted beam	
Light source	Laser, red
Typ. light spot size (distance)	800 μm x 450 μm (35 mm)
Key laser figures	
Normative reference	IEC 60825-1:2014, EN 60825-1:2014
Laser class	1 ⁵⁾ 6)
Additional function	Averaging 1 ... 512x Automatic or manual sensitivity adjustment Switching mode: window (Wnd) Switching mode: distance to object (DtO) Switching mode: object between sensor and background (ObSB) Multifunctional input: laser-off / external teach-in / trigger
General notes	

¹⁾ Averaging function set to: 512.

²⁾ Constant ambient conditions.

³⁾ Measurement on 90 % remission (ceramic, white).

⁴⁾ With fixed sensitivity adjustment and averaging setting = 1. With automatic sensitivity and measuring rate 500 μs: 2 ... 7.5 ms response time/measuring rate 1,000 μs: 4 ... 15 ms response time.

⁵⁾ Wavelength: 655 nm, max. output: 390 μW (laser class 1) / < 1 mW (laser class 2).

⁶⁾ Do not intentionally look into the laser beam. Never point the laser beam at people's eyes.

	Note on use	The sensor head can be used with evaluation unit AOD1 or stand-alone via RS-485
	Note	Not free of paint wetting impairment substances.
Safety-related parameters	MTTF _D	101 years
	DC _{avg}	0%

¹⁾ Averaging function set to: 512.

²⁾ Constant ambient conditions.

³⁾ Measurement on 90 % remission (ceramic, white).

⁴⁾ With fixed sensitivity adjustment and averaging setting = 1. With automatic sensitivity and measuring rate 500 μs: 2 ... 7.5 ms response time/measuring rate 1,000 μs: 4 ... 15 ms response time.

⁵⁾ Wavelength: 655 nm, max. output: 390 μW (laser class 1) / < 1 mW (laser class 2).

⁶⁾ Do not intentionally look into the laser beam. Never point the laser beam at people's eyes.

Interfaces

Serial		✓, RS-485
PROFIBUS DP		✓
	Type of fieldbus integration	Optional, over external evaluation unit AOD1 and Gateway WI180C-PB
Digital output		
	Number	1 ... 3 ¹⁾
	Type	PNP/NPN, selectable
Analog output		
	Number	1 ¹⁾
	Type	Current output
	Current	4 mA ... 20 mA, ≤ 300 Ω

¹⁾ Optional over evaluation unit AOD1.

Electronics

Supply voltage U_B	DC 12 V (-5 %) ... DC 24 V (+10 %)
Power consumption	≤ 1.92 W ¹⁾
Warm-up time	≤ 5 min
Display	4-digit 7-segment display (plus 4 LEDs for status display)
Enclosure rating	IP67
Protection class	III
Connection type	
	Cable with male connector, M12, 5-pin, 30 cm

¹⁾ Without load, with current output.

Mechanics

Dimensions (W x H x D)	17.8 mm x 44.4 mm x 31 mm
Control elements	4 buttons
Housing material	Stainless steel
Window material	Plastic (PPSU)
Weight	70 g

Ambient data

Ambient temperature, operation	-10 °C ... +50 °C
---------------------------------------	-------------------

Ambient temperature, storage	-20 °C ... +60 °C
Min. rel. humidity (not condensing)	35 %
Max. rel. humidity (not condensing)	95 %
Temperature drift	± 0.08 % FS/K (FS = Full Scale = Measuring range of sensor)
Typ. Ambient light immunity	Artificial light: ≤ 3,000 lx Sunlight: ≤ 10,000 lx
Vibration resistance	10 Hz ... 55 Hz (amplitude 1.5 mm, x-, y-, z-axis 2 hours each)
Shock resistance	50 G (x, y, z axis 3 times each)

Certificates

EU declaration of conformity	✓
UK declaration of conformity	✓
ACMA declaration of conformity	✓
Moroccan declaration of conformity	✓
China RoHS	✓
Information according to Art. 3 of Data Act (Regulation EU 2023/2854)	✓

Classifications

ECLASS 5.0	27270801
ECLASS 5.1.4	27270801
ECLASS 6.0	27270801
ECLASS 6.2	27270801
ECLASS 7.0	27270801
ECLASS 8.0	27270801
ECLASS 8.1	27270801
ECLASS 9.0	27270801
ECLASS 10.0	27270801
ECLASS 11.0	27270801
ECLASS 12.0	27270916
ETIM 5.0	EC001825
ETIM 6.0	EC001825
ETIM 7.0	EC001825
ETIM 8.0	EC001825
UNSPSC 16.0901	41111613

Dimensional drawing Stainless steel housing

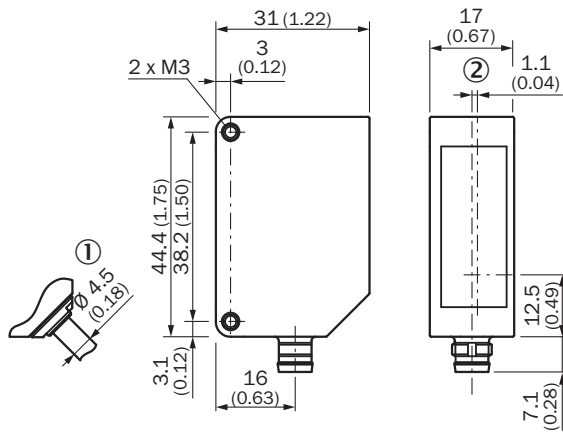

Dimensions in mm (inch)

- ① variant with 30 cm cable with M12, 5-pin connector
- ② Optical axis

Connection type

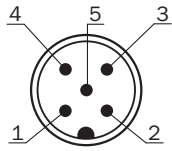

Connection diagram

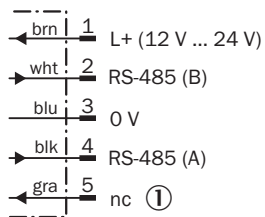

Adjustments

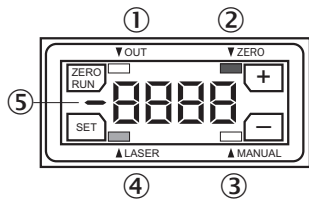

- ① digital output status indicator
- ② Zero offset status indicator
- ③ Teach mode status indicator
- ④ Laser status indicator
- ⑤ Minus sign for measured value indicator

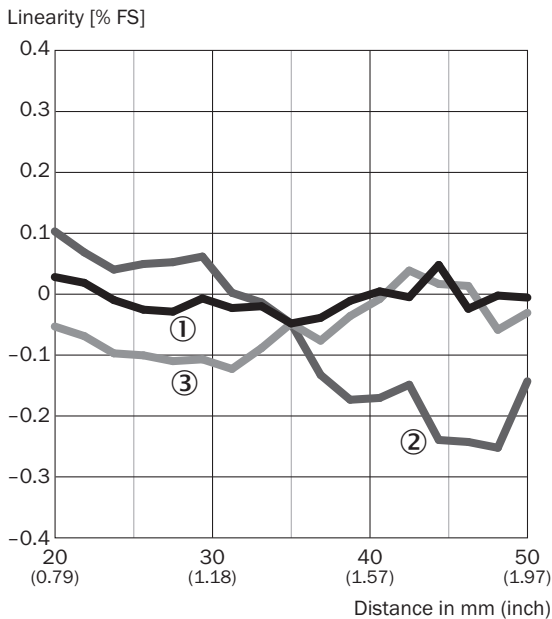

Linearity











- ① White ceramic
- ② stainless steel
- ③ black rubber

Recommended accessories

Other models and accessories → www.sick.com/OD_Mini

	Brief description	Type	part no.
connectors and cables			
	<ul style="list-style-type: none"> Description: Highly flexible Connection type head A: Female connector, M12, 4-pin, straight Connection type head B: Male connector, M8, 4-pin Cable: 2 m, PUR 	DSL-2804-G02MB	6059743
	<ul style="list-style-type: none"> Description: Sensor/actuator cable, unshielded Connection type head A: Female connector, M12, 4-pin, straight, A-coded Connection type head B: Male connector, M8, 4-pin, straight, A-coded Signal type: Sensor/actuator cable Cable: 2 m, 4-wire, PUR, halogen-free Application: Drag chain operation, Zones with oils and lubricants, Robot, Drag chain operation 	YF2A14-020UA3M8U14	2096112
	<ul style="list-style-type: none"> Description: Sensor/actuator cable, unshielded Connection type head A: Female connector, M12, 5-pin, straight, A-coded Connection type head B: Flying leads Signal type: Sensor/actuator cable Cable: 2 m, 5-wire, PUR, halogen-free Application: Drag chain operation, Zones with oils and lubricants, Robot, Drag chain operation 	YF2A15-020UB5XLEAX	2095617

	Brief description	Type	part no.
Mounting systems			
	<ul style="list-style-type: none"> Description: Mounting bracket, no alignment bracket Material: Stainless steel Details: Stainless steel 	BEF-OD1-B	5328344
	<ul style="list-style-type: none"> Description: Mounting bracket, for wall installation, no alignment bracket Material: Stainless steel Details: Stainless steel 	BEF-OD1-A	5328343
integration modules and adapters			
	<ul style="list-style-type: none"> Description: OD Mini evaluation unit, master, 1 x Q, M8 male connector, 4-pin 	AOD1-MR24Q1	6054270
	<ul style="list-style-type: none"> Description: OD Mini evaluation unit, slave, 1 x Q, M8 male connector, 4-pin 	AOD1-SR24Q1	6054271
	<ul style="list-style-type: none"> Description: OD Mini evaluation unit, master, 2 x Q, M12 male connector, 5-pin 	AOD1-MR25Q2	6054272
	<ul style="list-style-type: none"> Description: OD Mini evaluation unit, slave, 2 x Q, M12 male connector, 5-pin 	AOD1-SR25Q2	6054273
	<ul style="list-style-type: none"> Description: OD Mini evaluation unit, OD5000 and OL1, master, 3 x Q, 1 x analog, open end cable, 2 m 	AOD1-MR27C4	6058195
	<ul style="list-style-type: none"> Description: OD Mini evaluation unit, OD5000 and OL1, slave, 3 x Q, 1 x analog, open end cable, 2 m 	AOD1-SR27C4	6058196

SICK AT A GLANCE

SICK is one of the leading manufacturers of intelligent sensors and sensor solutions for industrial applications. A unique range of products and services creates the perfect basis for controlling processes securely and efficiently, protecting individuals from accidents and preventing damage to the environment.

We have extensive experience in a wide range of industries and understand their processes and requirements. With intelligent sensors, we can deliver exactly what our customers need. In application centers in Europe, Asia and North America, system solutions are tested and optimized in accordance with customer specifications. All this makes us a reliable supplier and development partner.

Comprehensive services complete our offering: SICK LifeTime Services provide support throughout the machine life cycle and ensure safety and productivity.

For us, that is “Sensor Intelligence.”

WORLDWIDE PRESENCE:

Contacts and other locations –www.sick.com