



# WT100-2P1439

W100-2

PHOTOELECTRIC SENSORS

**SICK**  
Sensor Intelligence.



Illustration may differ



### Ordering information

Type	part no.
WT100-2P1439	6052372

**Included in delivery:** BEF-W100-A (1)

Other models and accessories → [www.sick.com/W100-2](http://www.sick.com/W100-2)

### Detailed technical data

#### Features

<b>Functional principle</b>	Photoelectric proximity sensor
<b>Functional principle detail</b>	Energetic
<b>Dimensions (W x H x D)</b>	11 mm x 31 mm x 20 mm
<b>Housing design (light emission)</b>	Rectangular
<b>Sensing range max.</b>	0 mm ... 1,200 mm <sup>1)</sup>
<b>Sensing range</b>	0 mm ... 750 mm <sup>1)</sup>
<b>Type of light</b>	Visible red light
<b>Light source</b>	LED <sup>2)</sup>
<b>Light spot size (distance)</b>	Ø 75 mm (1,000 mm)
<b>Wave length</b>	632 nm
<b>Adjustment</b>	Potentiometer (Sensing range)

<sup>1)</sup> Object with 90% remission (based on standard white, DIN 5033).

<sup>2)</sup> Average service life: 100,000 h at T<sub>J</sub> = +25 °C.

## Mechanics/electronics

<b>Supply voltage <math>U_B</math></b>	10 V DC ... 30 V DC <sup>1)</sup>
<b>Ripple</b>	$\pm 10\%$ <sup>2)</sup>
<b>Current consumption</b>	30 mA <sup>3)</sup>
<b>Switching output</b>	PNP
<b>Switching mode</b>	Light/dark switching
<b>Switching mode selector</b>	Selectable via light/dark rotary switch
<b>Signal voltage PNP HIGH/LOW</b>	$U_V - 1,8\text{ V} / \text{ca. } 0\text{ V}$
<b>Output current <math>I_{\text{max}}</math></b>	$\leq 100\text{ mA}$
<b>Response time</b>	$\leq 0,5\text{ ms}$ <sup>4)</sup>
<b>Switching frequency</b>	1,000 Hz <sup>5)</sup>
<b>Connection type</b>	Cable, 3-wire, 2 m <sup>6)</sup>
<b>Cable material</b>	Plastic, PVC
<b>Conductor cross section</b>	0.18 mm <sup>2</sup>
<b>Circuit protection</b>	A <sup>7)</sup> B <sup>8)</sup> D <sup>9)</sup>
<b>Protection class</b>	III
<b>Housing material</b>	Plastic, ABS/PC/POM
<b>Optics material</b>	Plastic, PMMA
<b>Enclosure rating</b>	IP67
<b>Items supplied</b>	Mounting bracket BEF-W100-A
<b>Ambient operating temperature</b>	-25 °C ... +55 °C
<b>Ambient temperature, storage</b>	-40 °C ... +70 °C

<sup>1)</sup> Limit values.

<sup>2)</sup> May not fall below or exceed  $U_V$  tolerances.

<sup>3)</sup> Without load.

<sup>4)</sup> Signal transit time with resistive load.

<sup>5)</sup> With light/dark ratio 1:1.

<sup>6)</sup> Do not bend below 0 °C.

<sup>7)</sup> A =  $V_S$  connections reverse-polarity protected.

<sup>8)</sup> B = output reverse-polarity protected.

<sup>9)</sup> D = outputs overcurrent and short-circuit protected.

## Safety-related parameters

<b>MTTF<sub>D</sub></b>	954 years
<b>DC<sub>avg</sub></b>	0 %

## Classifications

<b>ECLASS 5.0</b>	27270903
<b>ECLASS 5.1.4</b>	27270903
<b>ECLASS 6.0</b>	27270903
<b>ECLASS 6.2</b>	27270903
<b>ECLASS 7.0</b>	27270903

<b>ECLASS 8.0</b>	27270903
<b>ECLASS 8.1</b>	27270903
<b>ECLASS 9.0</b>	27270903
<b>ECLASS 10.0</b>	27270904
<b>ECLASS 11.0</b>	27270904
<b>ECLASS 12.0</b>	27270903
<b>ETIM 5.0</b>	EC001821
<b>ETIM 6.0</b>	EC001821
<b>ETIM 7.0</b>	EC002719
<b>ETIM 8.0</b>	EC002719
<b>UNSPSC 16.0901</b>	39121528

### Certificates

<b>EU declaration of conformity</b>	✓
<b>UK declaration of conformity</b>	✓
<b>ACMA declaration of conformity</b>	✓
<b>Moroccan declaration of conformity</b>	✓
<b>China RoHS</b>	✓
<b>cRUus certificate</b>	✓
<b>Photobiological safety (DIN EN 62471) certificate</b>	✓

### Adjustments W100-2

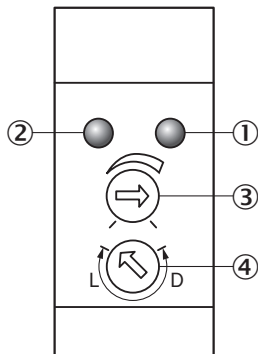

- ① LED indicator orange: switching output active
- ② LED indicator green: power on
- ③ Sensing range adjustment: potentiometer
- ④ Light/ dark rotary switch: L = light switching, D = dark switching

**Connection diagram Cd-043**

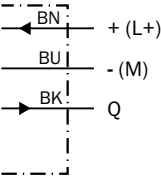

**Characteristic curve WT100-2, energetic**

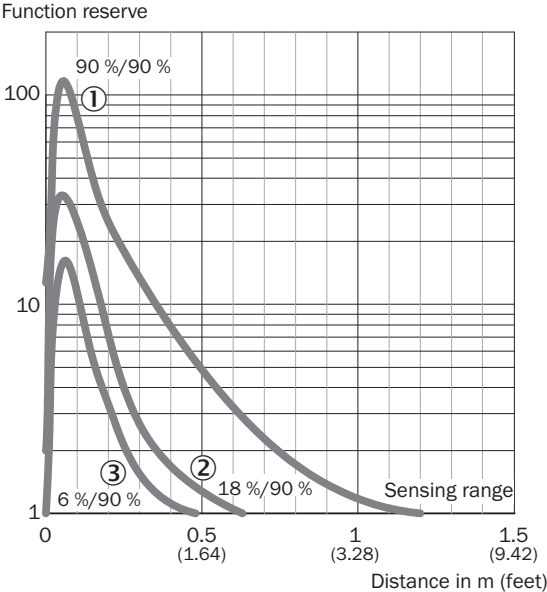

- ① Sensing range on white, 90% remission factor
- ② Sensing range on gray, 18% remission factor
- ③ Sensing range on black, 6% remission factor

**Light spot size**

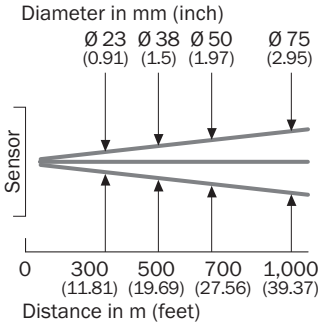

### Sensing range diagram WT100-2, energetic

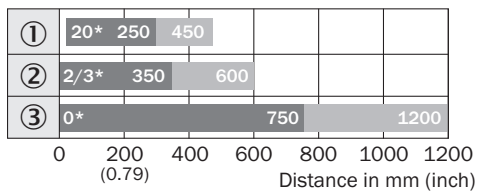

■ Sensing range      ■ Sensing range max.

\*Close-up range at maximum sensitivity

- ① Sensing range on black, 6% remission factor
- ② Sensing range on gray, 18% remission factor
- ③ Sensing range on white, 90% remission factor

### Dimensional drawing

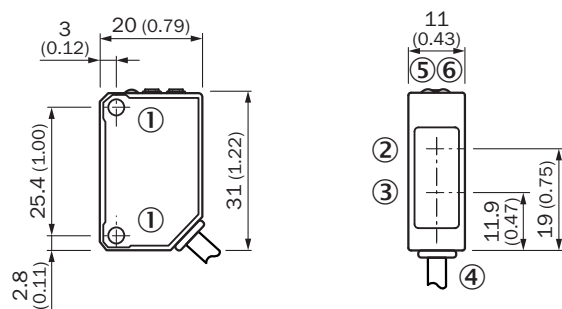





Dimensions in mm (inch)

- ① Threaded mounting hole M3
- ② Center of optical axis, receiver
- ③ Center of optical axis, sender
- ④ Connection
- ⑤ LED indicator orange: switching output active
- ⑥ LED indicator green: power on

## Recommended accessories

Other models and accessories → [www.sick.com/W100-2](http://www.sick.com/W100-2)

	Brief description	Type	part no.
Mounting systems			
	<ul style="list-style-type: none"> <li><b>Description:</b> Mounting bracket for wall mounting</li> <li><b>Material:</b> Stainless steel</li> <li><b>Details:</b> Stainless steel</li> <li><b>Items supplied:</b> Mounting hardware included</li> <li><b>Suitable for:</b> W8, W8G, W8 Laser, W8 Inox, G6, G6 Inox, W100 Laser, W100-2, KTM Core, KTM Prime, CSM, LUTM, W4S</li> </ul>	BEF-W100-A	5311520
	<ul style="list-style-type: none"> <li><b>Description:</b> Mounting bracket for floor mounting</li> <li><b>Material:</b> Steel</li> <li><b>Details:</b> Steel, zinc coated</li> <li><b>Items supplied:</b> Mounting hardware included</li> <li><b>Suitable for:</b> W8, W8G, W8 Laser, W8 Inox, G6, G6 Inox, W100 Laser, W100-2, KTM Core, KTM Prime, CSM, LUTM</li> </ul>	BEF-W100-B	5311521
	<ul style="list-style-type: none"> <li><b>Description:</b> Plate N11N for universal clamp bracket</li> <li><b>Material:</b> Stainless steel</li> <li><b>Details:</b> Stainless steel 1.4571 (sheet), Stainless steel 1.4408 (clamp)</li> <li><b>Items supplied:</b> Universal clamp (5322627), mounting hardware</li> <li><b>Usable for:</b> DeltaPac, Glare, WTD20E</li> </ul>	BEF-KHS-N11N	2071081
connectors and cables			
	<ul style="list-style-type: none"> <li><b>Description:</b> Unshielded</li> <li><b>Connection type head A:</b> Male connector, M8, 3-pin, straight, A-coded</li> <li><b>Connection systems:</b> Screw-type terminals</li> <li><b>Permitted cross-section:</b> 0.14 mm<sup>2</sup> ... 0.5 mm<sup>2</sup></li> </ul>	STE-0803-G	6037322

## SICK AT A GLANCE

SICK is one of the leading manufacturers of intelligent sensors and sensor solutions for industrial applications. A unique range of products and services creates the perfect basis for controlling processes securely and efficiently, protecting individuals from accidents and preventing damage to the environment.

We have extensive experience in a wide range of industries and understand their processes and requirements. With intelligent sensors, we can deliver exactly what our customers need. In application centers in Europe, Asia and North America, system solutions are tested and optimized in accordance with customer specifications. All this makes us a reliable supplier and development partner.

Comprehensive services complete our offering: SICK LifeTime Services provide support throughout the machine life cycle and ensure safety and productivity.

For us, that is “Sensor Intelligence.”

## WORLDWIDE PRESENCE:

Contacts and other locations –[www.sick.com](http://www.sick.com)