



CQ4-08EPSKU1

CQ

CAPACITIVE PROXIMITY SENSORS

SICK
Sensor Intelligence.



Illustration may differ



Ordering information

Type	part no.
CQ4-08EPSKU1	6051009

Other models and accessories → www.sick.com/CQ

Detailed technical data

Features

Housing	Rectangular
Dimensions (W x H x D)	16 mm x 39.5 mm x 12 mm
Sensing range S_n	1 mm ... 8 mm ¹⁾ 1 mm ... 6 mm ²⁾
Safe sensing range S_a	5.76 mm
Installation type	Non-flush Flush
Switching frequency	100 Hz
Connection type	Cable, 3-wire, 2 m ³⁾
Switching output	PNP
Switching output detail	PNP
Output function	NO
Electrical wiring	DC 3-wire
Adjustment	Potentiometer Sensitivity (5 turns)
Enclosure rating	IP67 ⁴⁾
Items supplied	Screwdriver for potentiometer adjustment (1 x)

¹⁾ For non-flush installation.

²⁾ For flush mounting.

³⁾ Do not bend below 0 °C.

⁴⁾ According to EN 60529.

Mechanics/electronics

Supply voltage	10 V DC ... 30 V DC
Ripple	≤ 10 %
Voltage drop	≤ 2.5 V DC ¹⁾
Current consumption	12 mA ²⁾
Time delay before availability	≤ 200 ms
Hysteresis	4 % ... 20 % ³⁾
Reproducibility	≤ 5 % ⁴⁾ ⁵⁾
Temperature drift (of S_r)	± 20 %
EMC	According to EN 60947-5-2
Continuous current I_a	≤ 150 mA
Cable material	PVC
Short-circuit protection	✓
Power-up pulse protection	✓
Shock and vibration resistance	30 g, 11 ms / 10 ... 55 Hz, 1 mm
Ambient operating temperature	-20 °C ... +75 °C
Ambient temperature, storage	-40 °C ... +85 °C
Housing material	Plastic, ABS
Sensing face material	Plastic
UL File No.	NRKH.E191603

¹⁾ At I_a max.

²⁾ Without load.

³⁾ Depending on installation and environmental conditions and sensitivity adjustment, hysteresis may vary.

⁴⁾ Of S_r.

⁵⁾ Supply voltage U_B and constant ambient temperature T_a.

Safety-related parameters

MTTF_D	1,344 years
DC_{avg}	0 %
T_M (mission time)	20 years

Reduction factors

Note	The values are reference values which may vary
Metal	1
Water	1
PVC	Approx. 0.4
Oil	Approx. 0.25
Glass	0.6
Ceramics	0.5
Alcohol	0.7
Wood	0.2 ... 0.7

Installation note

Remark	Associated graphic see "Installation"
A	16 mm
B	16 mm
F	48 mm

Certificates

EU declaration of conformity	✓
UK declaration of conformity	✓
Moroccan declaration of conformity	✓
China RoHS	✓
cULus certificate	✓

Classifications

ECLASS 5.0	27270102
ECLASS 5.1.4	27270102
ECLASS 6.0	27270102
ECLASS 6.2	27270102
ECLASS 7.0	27270102
ECLASS 8.0	27270102
ECLASS 8.1	27270102
ECLASS 9.0	27270102
ECLASS 10.0	27270102
ECLASS 11.0	27270102
ECLASS 12.0	27274201
ETIM 5.0	EC002715
ETIM 6.0	EC002715
ETIM 7.0	EC002715
ETIM 8.0	EC002715
UNSPSC 16.0901	39122230

Installation note

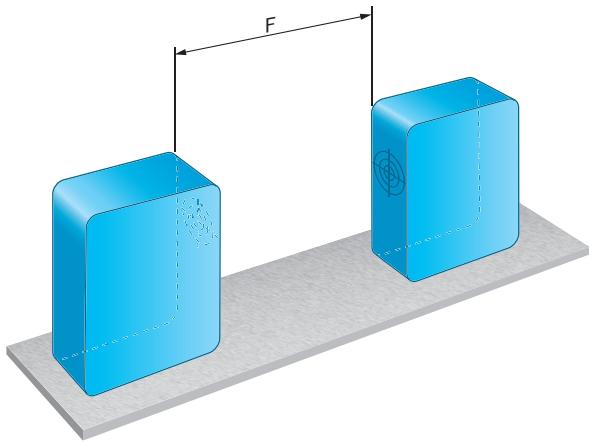

Installation note

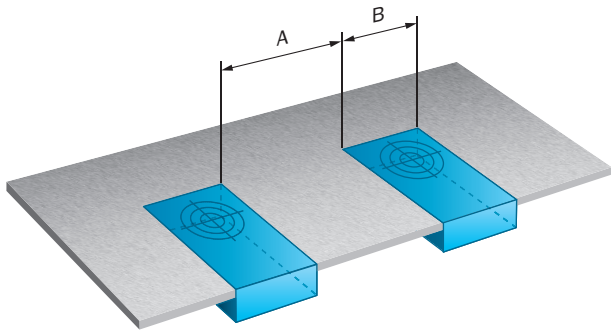

Connection diagram Cd-043

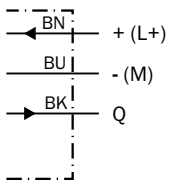

Response diagram CQ4, Non-flush installation

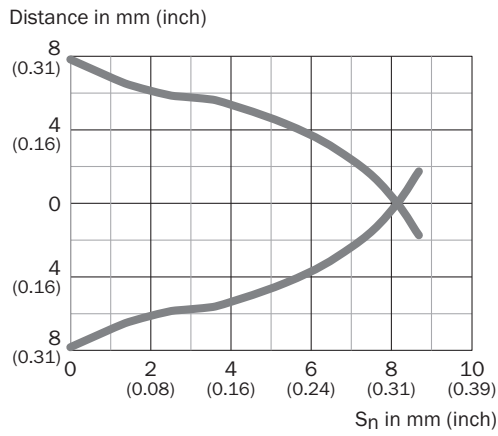

Response diagram CQ4, Flush installation

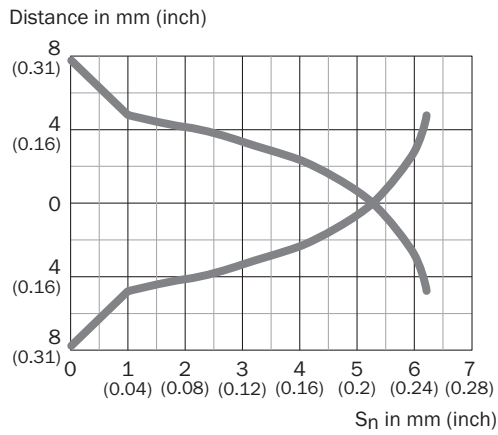

Dimensional drawing CQ4, cable

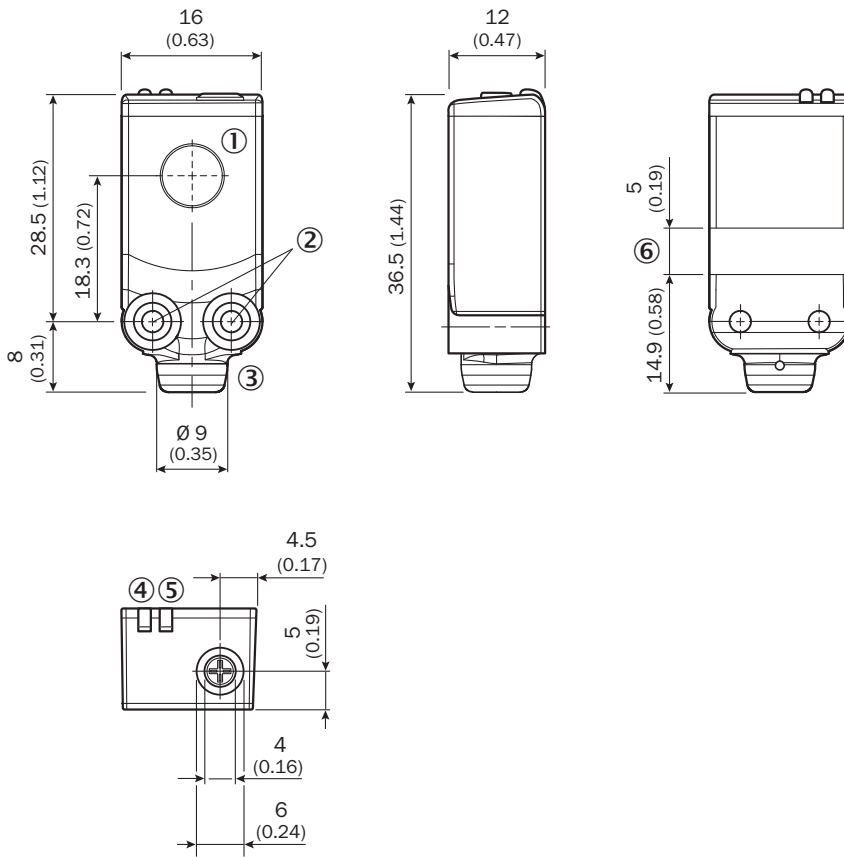







Dimensions in mm (inch)

- ① Sensing face
- ② Threaded hole M3 (2 x)
- ③ Connection
- ④ yellow LED: status detection of object/medium
- ⑤ LED green: operating indicator
- ⑥ line for cable tie

Recommended accessories

Other models and accessories → www.sick.com/CQ

	Brief description	Type	part no.
Mounting systems			
	<ul style="list-style-type: none"> Description: Mounting bracket for wall mounting Material: Stainless steel Details: Stainless steel 1.4571 Items supplied: Mounting hardware included Suitable for: W4S, W4F, W4S 	BEF-W4-A	2051628
	<ul style="list-style-type: none"> Description: Mounting bracket for floor mounting Material: Stainless steel Details: Stainless steel 1.4571 Items supplied: Mounting hardware included Suitable for: W4S, W4F, W4S 	BEF-W4-B	2051630
	<ul style="list-style-type: none"> Description: Ball clamp bracket Material: Plastic Details: Plastic Items supplied: Mounting hardware included Suitable for: W2S-2, W4-3 	BEF-GH-MINI01	2023160
connectors and cables			
	<ul style="list-style-type: none"> Description: Unshielded Connection type head A: Male connector, M8, 3-pin, straight, A-coded Connection systems: Screw-type terminals Permitted cross-section: 0.14 mm² ... 0.5 mm² 	STE-0803-G	6037322
	<ul style="list-style-type: none"> Description: Unshielded Connection type head A: Female connector, M8, 3-pin, straight, A-coded Connection systems: Screw-type terminals Permitted cross-section: 0.14 mm² ... 0.5 mm² 	DOS-0803-G	7902077
	<ul style="list-style-type: none"> Description: Unshielded Connection type head A: Female connector, M8, 3-pin, angled, A-coded Connection systems: Solder connection Permitted cross-section: ≤ 0.25 mm² 	DOS-0803-W	7902078

SICK AT A GLANCE

SICK is one of the leading manufacturers of intelligent sensors and sensor solutions for industrial applications. A unique range of products and services creates the perfect basis for controlling processes securely and efficiently, protecting individuals from accidents and preventing damage to the environment.

We have extensive experience in a wide range of industries and understand their processes and requirements. With intelligent sensors, we can deliver exactly what our customers need. In application centers in Europe, Asia and North America, system solutions are tested and optimized in accordance with customer specifications. All this makes us a reliable supplier and development partner.

Comprehensive services complete our offering: SICK LifeTime Services provide support throughout the machine life cycle and ensure safety and productivity.

For us, that is “Sensor Intelligence.”

WORLDWIDE PRESENCE:

Contacts and other locations –www.sick.com