



UM18-211161102

UM18

ULTRASONIC DISTANCE SENSORS

SICK
Sensor Intelligence.



Ordering information

Type	part no.
UM18-211161102	6048413

Other models and accessories → www.sick.com/UM18

Detailed technical data

Features

Operating range, limiting range	30 mm ... 250 mm, 350 mm
Resolution	≥ 0.2 mm
Repeatability	± 0.15 % ¹⁾
Measurement accuracy	± 1 % ²⁾
Response time	32 ms
Switching frequency	25 Hz
Output time	8 ms
Ultrasonic frequency (typical)	320 kHz
Detection area (typical)	See diagrams
Additional function	Set switching mode: Distance to object (DtO) / Window (Wnd) / Object between sensor and background (ObSB) Teach-in of digital output Invertible digital output Reset to factory default
Safety-related parameters	
	MTTF _D 101 years
	DC _{avg} 0%

¹⁾ In relation to the current measured value, minimum value ≥ resolution.

²⁾ Referring to current measurement value.

Interfaces

Digital output	
	Number 1 ¹⁾
	Type PNP
	Maximum output current I _A ≤ 200 mA
Hysteresis	3 mm

¹⁾ PNP: HIGH = V_S - (< 2 V) / LOW = 0 V.

Electronics

Supply voltage U_B	DC 10 V ... 30 V ¹⁾
-------------------------------------	--------------------------------

¹⁾ Limit values, reverse-polarity protected Operation in short-circuit protected network: max. 8 A, class 2.

²⁾ Without load.

Power consumption	≤ 1.2 W ²⁾
Initialization time	< 300 ms
Display	2 x LED
Enclosure rating	IP65 / IP67
Protection class	III

¹⁾ Limit values, reverse-polarity protected Operation in short-circuit protected network: max. 8 A, class 2.

²⁾ Without load.

Mechanics

Dimensions (W x H x D)	18 mm x 18 mm x 68.7 mm
Design	Cylindrical
Sending axis	Angled
Housing material	Plastic (PBT, ultrasonic transducer: polyurethane foam, glass epoxy resin)
Weight	20 g
Thread size	M18 x 1
Connection type	Male connector, M12, 4-pin

Ambient data

Ambient temperature, operation	-25 °C ... +70 °C
Ambient temperature, storage	-40 °C ... +85 °C
Temperature drift	0.17 % / K ¹⁾

¹⁾ Referring to current measurement value.

Classifications

ECLASS 5.0	27270804
ECLASS 5.1.4	27270804
ECLASS 6.0	27270804
ECLASS 6.2	27270804
ECLASS 7.0	27270804
ECLASS 8.0	27270804
ECLASS 8.1	27270804
ECLASS 9.0	27270804
ECLASS 10.0	27270804
ECLASS 11.0	27270804
ECLASS 12.0	27272806
ETIM 5.0	EC001846
ETIM 6.0	EC001846
ETIM 7.0	EC001846
ETIM 8.0	EC001846
UNSPSC 16.0901	41111960

Dimensional drawing UM18-2xxxxx2

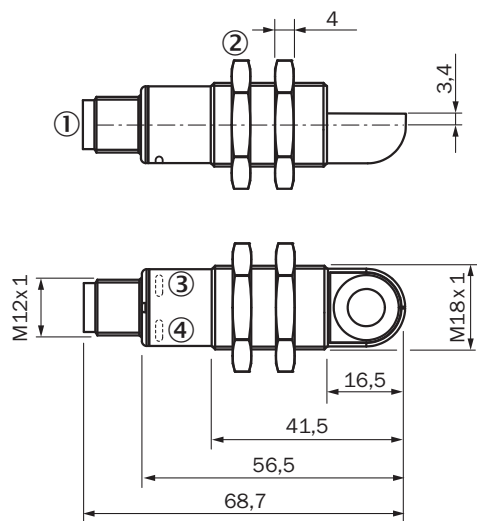

Dimensions in mm (inch)

- ① Connection
- ② Fixing nuts, width 24 mm
- ③ Status display for supply voltage active (green)
- ④ Status indicator switching/analog output (orange)

Connection type

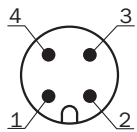

Connection diagram

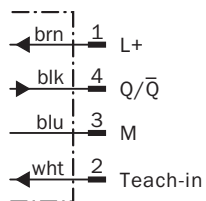

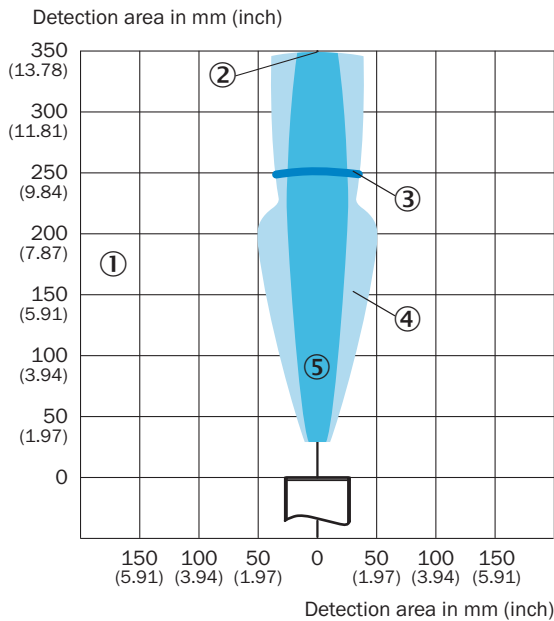

Detection area UM18-211





- ① Detection range dependent on reflection properties, size, and alignment of the object
- ② Limiting range
- ③ operating range
- ④ example object: aligned plate 500 mm x 500 mm
- ⑤ Example object: cylindrical bar with a diameter of 10 mm

Recommended accessories

Other models and accessories → www.sick.com/UM18

	Brief description	Type	part no.
Mounting systems			
	<ul style="list-style-type: none"> • Description: Mounting plate for M18 sensors • Material: Steel • Details: Steel, zinc coated • Items supplied: Without mounting hardware • Suitable for: GR18, V180-2, V18, W15, Z1, Z2 	BEF-WG-M18	5321870
reflectors and optics			
		USP-UM18	5323658

	Brief description	Type	part no.
connectors and cables			
	<ul style="list-style-type: none"> • Description: Sensor/actuator cable, unshielded • Connection type head A: Female connector, M12, 4-pin, straight, A-coded • Connection type head B: Flying leads • Signal type: Sensor/actuator cable • Cable: 2 m, 4-wire, PVC • Application: Uncontaminated zones, Zones with chemicals 	YF2A14-020VB3XLEAX	2096234
	<ul style="list-style-type: none"> • Description: Sensor/actuator cable, unshielded • Connection type head A: Female connector, M12, 4-pin, straight, A-coded • Connection type head B: Flying leads • Signal type: Sensor/actuator cable • Cable: 0.6 m, 4-wire, PVC • Application: Uncontaminated zones, Zones with chemicals 	YF2A14-C60VB3XLEAX	2145707
	<ul style="list-style-type: none"> • Description: Sensor/actuator cable, unshielded • Connection type head A: Female connector, M12, 4-pin, straight, A-coded • Connection type head B: Flying leads • Signal type: Sensor/actuator cable • Cable: 1 m, 4-wire, PVC • Application: Uncontaminated zones, Zones with chemicals 	YF2A14-010VB3XLEAX	2145708

SICK AT A GLANCE

SICK is one of the leading manufacturers of intelligent sensors and sensor solutions for industrial applications. A unique range of products and services creates the perfect basis for controlling processes securely and efficiently, protecting individuals from accidents and preventing damage to the environment.

We have extensive experience in a wide range of industries and understand their processes and requirements. With intelligent sensors, we can deliver exactly what our customers need. In application centers in Europe, Asia and North America, system solutions are tested and optimized in accordance with customer specifications. All this makes us a reliable supplier and development partner.

Comprehensive services complete our offering: SICK LifeTime Services provide support throughout the machine life cycle and ensure safety and productivity.

For us, that is “Sensor Intelligence.”

WORLDWIDE PRESENCE:

Contacts and other locations –www.sick.com