



# OD2-N50W10C0

OD Value

DISPLACEMENT SENSORS

**SICK**  
Sensor Intelligence.



Illustration may differ



### Ordering information

Type	part no.
OD2-N50W10C0	6036590

Other models and accessories → [www.sick.com/OD\\_Value](http://www.sick.com/OD_Value)

### Detailed technical data

#### Features

<b>Measuring range</b>	40 mm ... 60 mm <sup>1)</sup>
<b>Repeatability</b>	5 μm <sup>2) 3) 4)</sup>
<b>Linearity</b>	± 20 μm <sup>2) 3) 5)</sup>
<b>Response time</b>	≥ 1 ms
<b>Measuring frequency</b>	≤ 2 kHz <sup>1)</sup>
<b>Output time</b>	≥ 0.5 ms
<b>Emitted beam</b>	
Light source	Laser, red
Typ. light spot size (distance)	0.5 mm x 1 mm (50 mm)
<b>Key laser figures</b>	
Normative reference	IEC 60825-1:2014, EN 60825-1:2014
Laser class	2 <sup>6)</sup> 7)
<b>Additional function</b>	Mean-value setting 1 ... 64x Automatic sensitivity adjustment Teach-in of digital output Invertable switching output Multifunctional input: laser-off / external teach-in / trigger Switching mode: distance to object (DtO) Switching mode: window (Wnd)

<sup>1)</sup> 6% ... 90% remission factor.

<sup>2)</sup> Measurement on 90 % remission (ceramic, white).

<sup>3)</sup> At averaging function medium.

<sup>4)</sup> Constant ambient conditions.

<sup>5)</sup> When calibrated in the application regularly.

<sup>6)</sup> Wavelength: 655 nm, max. output: 1 mW.

<sup>7)</sup> Do not intentionally look into the laser beam. Never point the laser beam at people's eyes.

Safety-related parameters	
MTTF <sub>D</sub>	101 years
DC <sub>avg</sub>	0%

- 1) 6% ... 90% remission factor.
- 2) Measurement on 90 % remission (ceramic, white).
- 3) At averaging function medium.
- 4) Constant ambient conditions.
- 5) When calibrated in the application regularly.
- 6) Wavelength: 655 nm, max. output: 1 mW.
- 7) Do not intentionally look into the laser beam. Never point the laser beam at people's eyes.

## Interfaces

<b>Digital output</b>	Number	2 <sup>1)</sup>
	Type	NPN
	Maximum output current I <sub>A</sub>	≤ 100 mA
<b>Multifunctional input (MF)</b>		1 x MF <sup>2)</sup>

- 1) PNP: HIGH = V<sub>S</sub> - (< 2 V) / LOW = < 2 V; NPN: HIGH = < 2 V / LOW = V<sub>S</sub>.
- 2) MF can be used as laser-off, trigger, external teach-in, or deactivated; response time ≤ 3 ms.

## Electronics

<b>Supply voltage U<sub>B</sub></b>	DC 12 V ... 24 V
<b>Power consumption</b>	≤ 2.88 W <sup>1)</sup>
<b>Warm-up time</b>	≤ 30 min
<b>Display</b>	Distance bar graph, up to 8 status LEDs
<b>Enclosure rating</b>	IP67
<b>Protection class</b>	III
<b>Connection type</b>	Male connector

- 1) Without load, with current output.

## Mechanics

<b>Dimensions (W x H x D)</b>	20.4 mm x 60 mm x 50 mm
<b>Housing material</b>	Plastic (PBT)
<b>Window material</b>	Plastic (PMMA)
<b>Weight</b>	70 g

## Ambient data

<b>Ambient temperature, operation</b>	-10 °C ... +40 °C
<b>Ambient temperature, storage</b>	-20 °C ... +60 °C
<b>Relative air humidity (non-condensing)</b>	35 % ... 95 %
<b>Temperature drift</b>	± 0.08 % FS/K (FS = Full Scale = Measuring range of sensor)
<b>Typ. Ambient light immunity</b>	Artificial light: ≤ 3,000 lx Sunlight: ≤ 10,000 lx
<b>Vibration resistance</b>	10 Hz ... 55 Hz (amplitude 1.5 mm, x-, y-, z-axis 2 hours each)

<b>Shock resistance</b>	50 G (x, y, z axis 3 times each)
-------------------------	----------------------------------

### Classifications

<b>ECLASS 5.0</b>	27270801
<b>ECLASS 5.1.4</b>	27270801
<b>ECLASS 6.0</b>	27270801
<b>ECLASS 6.2</b>	27270801
<b>ECLASS 7.0</b>	27270801
<b>ECLASS 8.0</b>	27270801
<b>ECLASS 8.1</b>	27270801
<b>ECLASS 9.0</b>	27270801
<b>ECLASS 10.0</b>	27270801
<b>ECLASS 11.0</b>	27270801
<b>ECLASS 12.0</b>	27270916
<b>ETIM 5.0</b>	EC001825
<b>ETIM 6.0</b>	EC001825
<b>ETIM 7.0</b>	EC001825
<b>ETIM 8.0</b>	EC001825
<b>UNSPSC 16.0901</b>	41111613

### Certificates

<b>EU declaration of conformity</b>	✓
<b>UK declaration of conformity</b>	✓
<b>ACMA declaration of conformity</b>	✓
<b>Moroccan declaration of conformity</b>	✓
<b>China RoHS</b>	✓
<b>Information according to Art. 3 of Data Act (Regulation EU 2023/2854)</b>	✓

### Dimensional drawing OD2-x50W10xx

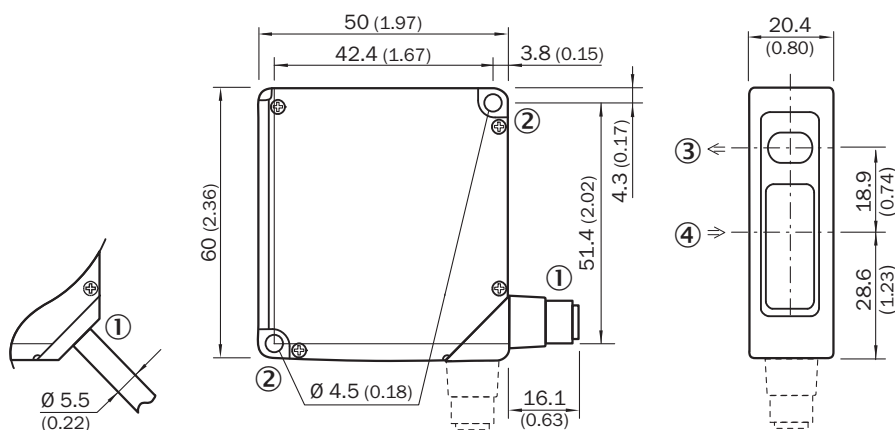

Dimensions in mm (inch)

- ① 2 m cable or M12 connector; 90° rotatable
- ② Mounting hole, Ø 4.5 mm
- ③ optical axis, sender
- ④ optical axis, receiver

Connection type OD2-xxxxxA0 OD2-xxxxxC0 OD2-xxxxxI0 OD2-xxxxxU0 connector M12, 8-pin

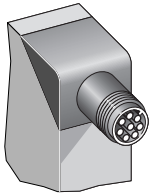

### Connection diagram

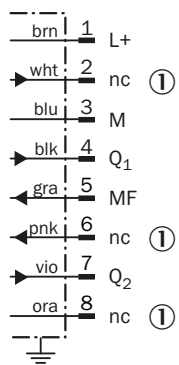

① Not assigned

### Adjustment possible OD2-xxxxxCx

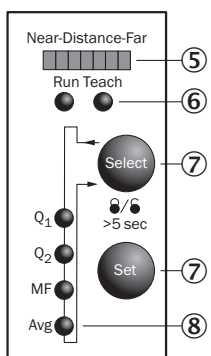

- ⑤ Distance indicator
- ⑥ mode indicator (Run/Teach)
- ⑦ Control elements
- ⑧ status indicator in- and outputs (Run-mode)/menu indicator (Teach-mode)

### Light spot size OD2-x50W10xx

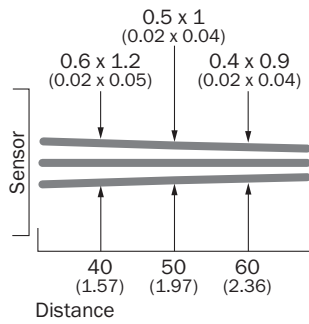

All dimensions in mm (inch)

### Linearity OD2-x50xxxx

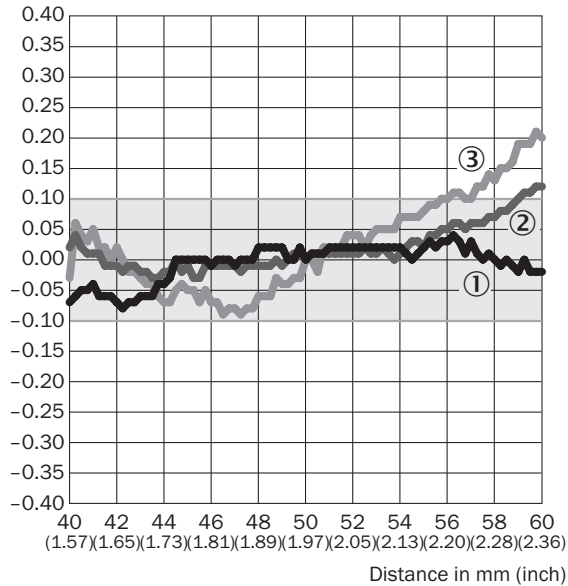

Linearity [%FS]



- ① White ceramic
- ② Black paper
- ③ stainless steel

Recommended accessories

Other models and accessories → [www.sick.com/OD\\_Value](http://www.sick.com/OD_Value)

	Brief description	Type	part no.
connectors and cables			
	<ul style="list-style-type: none"> <li>• <b>Connection type head A:</b> Female connector, M12, 8-pin, straight</li> <li>• <b>Connection type head B:</b> Flying leads</li> <li>• <b>Signal type:</b> Sensor/actuator cable</li> <li>• <b>Cable:</b> 2 m, 8-wire, PVC</li> <li>• <b>Description:</b> Sensor/actuator cable, special color code, shielded</li> <li>• <b>Connection systems:</b> Flying leads</li> <li>• <b>Application:</b> Uncontaminated zones, Zones with chemicals</li> </ul>	DOL-1208-G02MF	6020663
Mounting systems			
	<ul style="list-style-type: none"> <li>• <b>Description:</b> Stainless-steel mounting bracket</li> <li>• <b>Material:</b> Stainless steel</li> <li>• <b>Details:</b> Stainless steel</li> </ul>	BEF-WN-OD1000	4089813

## SICK AT A GLANCE

SICK is one of the leading manufacturers of intelligent sensors and sensor solutions for industrial applications. A unique range of products and services creates the perfect basis for controlling processes securely and efficiently, protecting individuals from accidents and preventing damage to the environment.

We have extensive experience in a wide range of industries and understand their processes and requirements. With intelligent sensors, we can deliver exactly what our customers need. In application centers in Europe, Asia and North America, system solutions are tested and optimized in accordance with customer specifications. All this makes us a reliable supplier and development partner.

Comprehensive services complete our offering: SICK LifeTime Services provide support throughout the machine life cycle and ensure safety and productivity.

For us, that is “Sensor Intelligence.”

## WORLDWIDE PRESENCE:

Contacts and other locations –[www.sick.com](http://www.sick.com)