



OD2-N50W10A2

OD Value

DISPLACEMENT SENSORS

SICK
Sensor Intelligence.



Illustration may differ



Ordering information

Type	part no.
OD2-N50W10A2	6036587

Other models and accessories → www.sick.com/OD_Value

Detailed technical data

Features

Measuring range	40 mm ... 60 mm ¹⁾
Repeatability	5 μm ^{2) 3) 4)}
Linearity	± 20 μm ^{2) 3) 5)}
Response time	≥ 1 ms
Measuring frequency	≤ 2 kHz ¹⁾
Output time	≥ 0.5 ms
Emitted beam	
Light source	Laser, red
Typ. light spot size (distance)	0.5 mm x 1 mm (50 mm)
Key laser figures	
Normative reference	IEC 60825-1:2014, EN 60825-1:2014
Laser class	2 ⁶⁾
	7)
Additional function	Mean-value setting 1 ... 64x Automatic sensitivity adjustment Teach-in of digital output Invertable switching output Multifunctional input: laser-off / external teach-in / trigger Switching mode: distance to object (DtO) Switching mode: window (Wnd)

¹⁾ 6% ... 90% remission factor.

²⁾ Measurement on 90 % remission (ceramic, white).

³⁾ At averaging function medium.

⁴⁾ Constant ambient conditions.

⁵⁾ When calibrated in the application regularly.

⁶⁾ Wavelength: 655 nm, max. output: 1 mW.

⁷⁾ Do not intentionally look into the laser beam. Never point the laser beam at people's eyes.

Safety-related parameters	
MTTF _D	101 years
DC _{avg}	0%

- 1) 6% ... 90% remission factor.
- 2) Measurement on 90 % remission (ceramic, white).
- 3) At averaging function medium.
- 4) Constant ambient conditions.
- 5) When calibrated in the application regularly.
- 6) Wavelength: 655 nm, max. output: 1 mW.
- 7) Do not intentionally look into the laser beam. Never point the laser beam at people's eyes.

Interfaces

Serial	✓ , RS-422
Digital output	
Number	1 ¹⁾
Type	NPN
Maximum output current I _A	≤ 100 mA
Multifunctional input (MF)	1 x MF ²⁾

- 1) PNP: HIGH = V_S - (< 2 V) / LOW = < 2 V; NPN: HIGH = < 2 V / LOW = V_S.
- 2) MF can be used as laser-off, trigger, external teach-in, or deactivated; response time ≤ 3 ms.

Electronics

Supply voltage U_B	DC 12 V ... 24 V
Power consumption	≤ 2.88 W ¹⁾
Warm-up time	≤ 30 min
Display	Distance bar graph, up to 8 status LEDs
Enclosure rating	IP67
Protection class	III
Connection type	Cable, 2 m

- 1) Without load, with current output.

Mechanics

Dimensions (W x H x D)	20.4 mm x 60 mm x 50 mm
Housing material	Plastic (PBT)
Window material	Plastic (PMMA)
Weight	70 g

Ambient data

Ambient temperature, operation	-10 °C ... +40 °C
Ambient temperature, storage	-20 °C ... +60 °C
Relative air humidity (non-condensing)	35 % ... 95 %
Temperature drift	± 0.08 % FS/K (FS = Full Scale = Measuring range of sensor)
Typ. Ambient light immunity	Artificial light: ≤ 3,000 lx Sunlight: ≤ 10,000 lx

Vibration resistance	10 Hz ... 55 Hz (amplitude 1.5 mm, x-, y-, z-axis 2 hours each)
Shock resistance	50 G (x, y, z axis 3 times each)

Classifications

ECLASS 5.0	27270801
ECLASS 5.1.4	27270801
ECLASS 6.0	27270801
ECLASS 6.2	27270801
ECLASS 7.0	27270801
ECLASS 8.0	27270801
ECLASS 8.1	27270801
ECLASS 9.0	27270801
ECLASS 10.0	27270801
ECLASS 11.0	27270801
ECLASS 12.0	27270916
ETIM 5.0	EC001825
ETIM 6.0	EC001825
ETIM 7.0	EC001825
ETIM 8.0	EC001825
UNSPSC 16.0901	41111613

Certificates

EU declaration of conformity	✓
UK declaration of conformity	✓
ACMA declaration of conformity	✓
Moroccan declaration of conformity	✓
China RoHS	✓
Information according to Art. 3 of Data Act (Regulation EU 2023/2854)	✓

Dimensional drawing OD2-x50W10xx

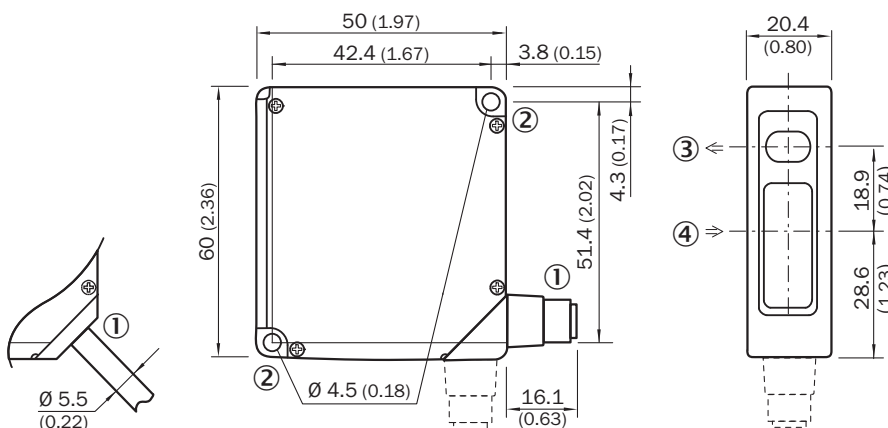

Dimensions in mm (inch)

- ① 2 m cable or M12 connector; 90° rotatable
- ② Mounting hole, Ø 4.5 mm
- ③ optical axis, sender
- ④ optical axis, receiver

Connection type OD2-xxxxxA2 OD2-xxxxxC2 OD2-xxxxxI2 OD2-xxxxxU2 cable

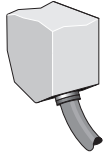

Connection diagram

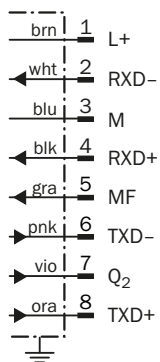

- ① Multifunctional input (MF)

Adjustment possible OD2-xxxxxAx

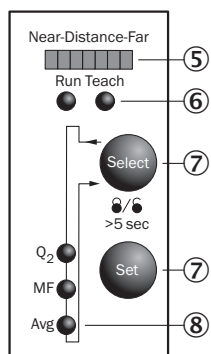

- ⑤ Distance indicator
- ⑥ mode indicator (Run/Teach)
- ⑦ Control elements
- ⑧ status indicator in- and outputs (Run-mode)/menu indicator (Teach-mode)

Light spot size OD2-x50W10xx

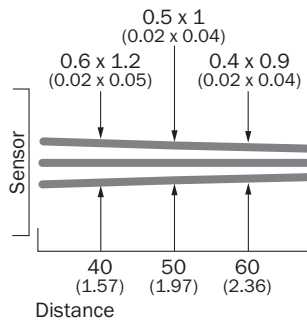

All dimensions in mm (inch)

Linearity OD2-x50xxxxx

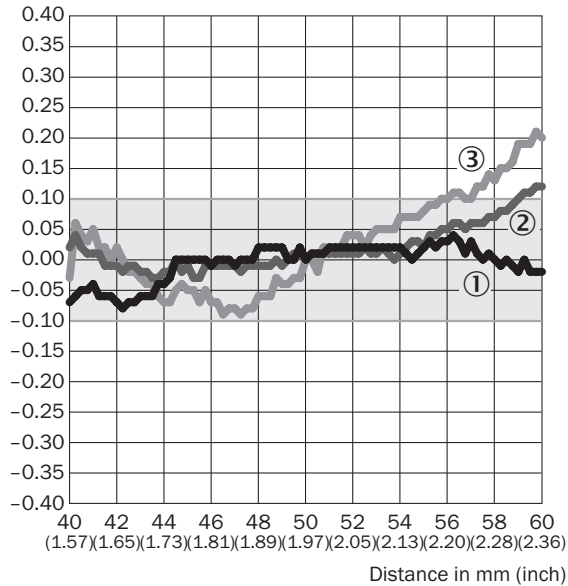

Linearity [%FS]



- ① White ceramic
- ② Black paper
- ③ stainless steel

Recommended accessories

Other models and accessories → www.sick.com/OD_Value

	Brief description	Type	part no.
connectors and cables			
	<ul style="list-style-type: none"> • Connection type head A: Female connector, M12, 8-pin, straight • Connection type head B: Flying leads • Signal type: Sensor/actuator cable • Cable: 2 m, 8-wire, PVC • Description: Sensor/actuator cable, special color code, shielded • Connection systems: Flying leads • Application: Uncontaminated zones, Zones with chemicals 	DOL-1208-G02MF	6020663
Mounting systems			
	<ul style="list-style-type: none"> • Description: Stainless-steel mounting bracket • Material: Stainless steel • Details: Stainless steel 	BEF-WN-OD1000	4089813

SICK AT A GLANCE

SICK is one of the leading manufacturers of intelligent sensors and sensor solutions for industrial applications. A unique range of products and services creates the perfect basis for controlling processes securely and efficiently, protecting individuals from accidents and preventing damage to the environment.

We have extensive experience in a wide range of industries and understand their processes and requirements. With intelligent sensors, we can deliver exactly what our customers need. In application centers in Europe, Asia and North America, system solutions are tested and optimized in accordance with customer specifications. All this makes us a reliable supplier and development partner.

Comprehensive services complete our offering: SICK LifeTime Services provide support throughout the machine life cycle and ensure safety and productivity.

For us, that is “Sensor Intelligence.”

WORLDWIDE PRESENCE:

Contacts and other locations –www.sick.com