



AOD-N1

Display modules

INTEGRATION MODULES AND ADAPTERS

SICK
Sensor Intelligence.

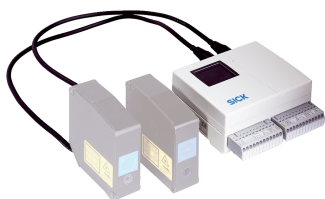

Ordering information

Type	part no.
AOD-N1	6028961

Other models and accessories → www.sick.com/Display_modules

Detailed technical data

Features

Product segment	Integration modules and adapters
Product	Display modules
Description	OD Max evaluation unit, 5x NPN, required for OD350-x, OD85-x and OD30-x
Enclosure rating	IP20
Power consumption	1)
Ambient operating temperature	-10 °C ... +45 °C
Weight	240 g

1) When connected with two sensor heads, incl. analog current output.

Classifications

ECLASS 5.0	27270890
ECLASS 5.1.4	27270890
ECLASS 6.0	27270890
ECLASS 6.2	27270890
ECLASS 7.0	27270890
ECLASS 8.0	27270890
ECLASS 8.1	27270890
ECLASS 9.0	27270892
ECLASS 10.0	27270892
ECLASS 11.0	27270892
ECLASS 12.0	27270992
ETIM 5.0	EC001825
ETIM 6.0	EC001825
ETIM 7.0	EC001825
ETIM 8.0	EC001825
UNSPSC 16.0901	41111613

Dimensional drawing AOD-xx AODG-xx

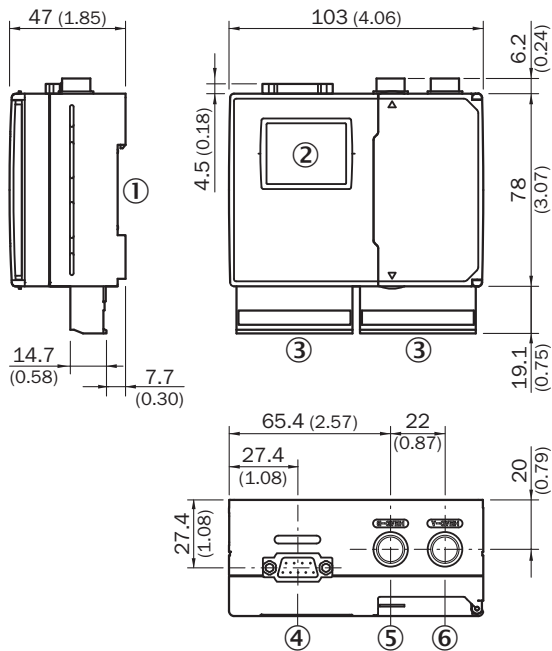

Dimensions in mm (inch)

- ① DIN rail mounting
- ② LC display
- ③ terminal board (detachable)
- ④ RS-232C interface
- ⑤ sensor head B connection port
- ⑥ sensor head A connection port

Connection diagram RS-232C

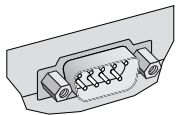

Terminal block connection type

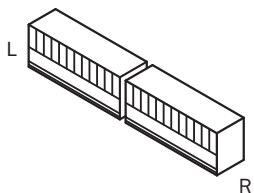

Terminal block connection diagram

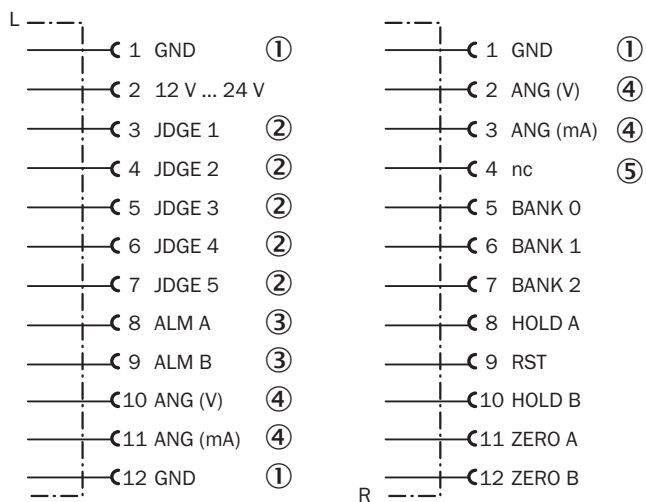

- ① Ground (0 V)
- ② Judgement Output = digital output
- ③ Alarm output
- ④ Analog output
- ⑤ Not assigned

Anschlusschema Evaluation unit RS-232C

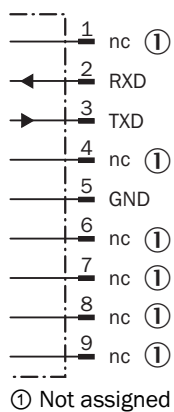

- ① Not assigned

Adjustments AOD-xx AODG-xx

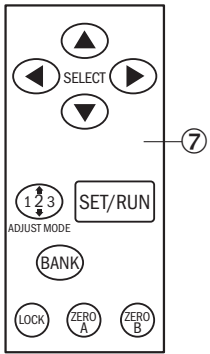

⑦ Control elements

SICK AT A GLANCE

SICK is one of the leading manufacturers of intelligent sensors and sensor solutions for industrial applications. A unique range of products and services creates the perfect basis for controlling processes securely and efficiently, protecting individuals from accidents and preventing damage to the environment.

We have extensive experience in a wide range of industries and understand their processes and requirements. With intelligent sensors, we can deliver exactly what our customers need. In application centers in Europe, Asia and North America, system solutions are tested and optimized in accordance with customer specifications. All this makes us a reliable supplier and development partner.

Comprehensive services complete our offering: SICK LifeTime Services provide support throughout the machine life cycle and ensure safety and productivity.

For us, that is “Sensor Intelligence.”

WORLDWIDE PRESENCE:

Contacts and other locations –www.sick.com