



# i10-HA113

i10H

**ELECTRO-MECHANICAL SAFETY SWITCHES**

**SICK**  
Sensor Intelligence.

### Ordering information



Type	part no.
i10-HA113	6025050

Other models and accessories → [www.sick.com/i10H](http://www.sick.com/i10H)



### Detailed technical data

#### Features

<b>Positive action N/C contacts</b>	1
<b>N/O contacts</b>	1
<b>Actuation frequency</b>	≤ 3,600 /h
<b>Actuation torque</b>	≥ 0.08 Nm
<b>Directions of rotation</b>	2
<b>Switching angle</b>	Adjustable 3° ... 11°

#### Safety-related parameters

<b>B<sub>10d</sub> parameter</b>	2 x 10 <sup>6</sup> switching cycles (with small load)
<b>Type</b>	Type 1 (EN ISO 14119)
<b>Actuator coding level</b>	Uncoded (EN ISO 14119)
<b>Safe state in the event of a fault</b>	The switch has no internal fault detection and is unable to assume a safe state in the event of a fault. Fault detection is performed by the connected safety-related logic unit.

#### Functions

<b>Safe series connection</b>	None, only individual wiring (with diagnostics)
-------------------------------	---

#### Interfaces

<b>Connection type</b>	Cable gland, 1 x M16
------------------------	----------------------

#### Electronics

<b>Switching principle</b>	Slow action switching element
<b>Usage category</b>	AC-15/DC-13 (IEC 60947-5-1)
<b>Rated operating current (voltage)</b>	3 A (240 V AC) 2 A (24 V DC)
<b>Rated insulation voltage U<sub>i</sub></b>	250 V
<b>Rated impulse withstand voltage U<sub>imp</sub></b>	2,500 V AC
<b>Short-circuit protection</b>	3 A gG
<b>Switching voltage</b>	≥ 5 V DC

<b>Switching current (switching voltage)</b>	5 mA (5 V DC)
--	---------------

### Mechanics

<b>Weight</b>	0.12 kg
<b>Housing material</b>	Glass-fiber reinforced polyester
<b>Mechanical life</b>	1 x 10 <sup>6</sup> switching cycles

### Ambient data

<b>Enclosure rating</b>	IP67 (IEC 60529)
<b>Ambient operating temperature</b>	-20 °C ... +80 °C
<b>Storage temperature</b>	-20 °C ... +80 °C

### Classifications

<b>ECLASS 5.0</b>	27272601
<b>ECLASS 5.1.4</b>	27272601
<b>ECLASS 6.0</b>	27272601
<b>ECLASS 6.2</b>	27272601
<b>ECLASS 7.0</b>	27272601
<b>ECLASS 8.0</b>	27272601
<b>ECLASS 8.1</b>	27272601
<b>ECLASS 9.0</b>	27272601
<b>ECLASS 10.0</b>	27272601
<b>ECLASS 11.0</b>	27272601
<b>ECLASS 12.0</b>	27272601
<b>ETIM 5.0</b>	EC001829
<b>ETIM 6.0</b>	EC001829
<b>ETIM 7.0</b>	EC001829
<b>ETIM 8.0</b>	EC001829
<b>UNSPSC 16.0901</b>	39122205

### Certificates

<b>EU declaration of conformity</b>	✓
<b>UK declaration of conformity</b>	✓
<b>cULus certificate</b>	✓

### Dimensional drawing

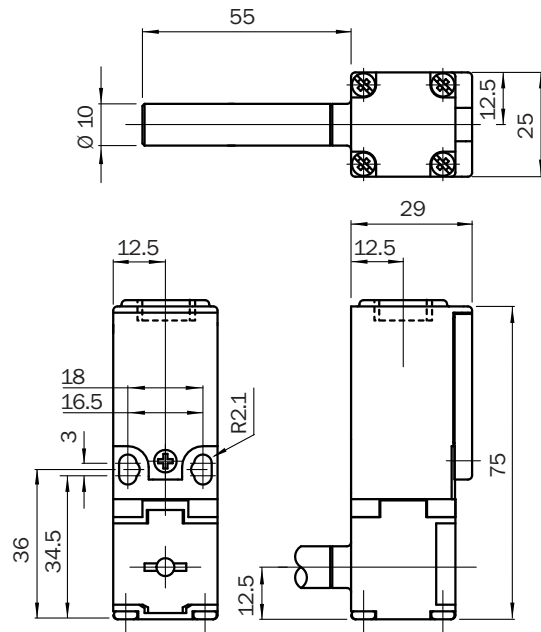

Dimensions in mm (inch)

### Actuator travel diagram

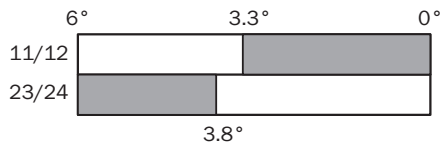

- Contacts open
- Contacts closed

Switching elements

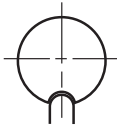
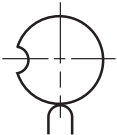
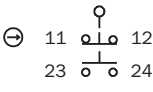
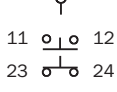
	Not actuated	Actuated
Switching element 11		
Switching element 21		

**Switching element 11:**

1 positive action N/C contact + 1 N/O contact

**Switching element 21:**

2 positive action N/C contacts + 1 N/O contact

Adjustments

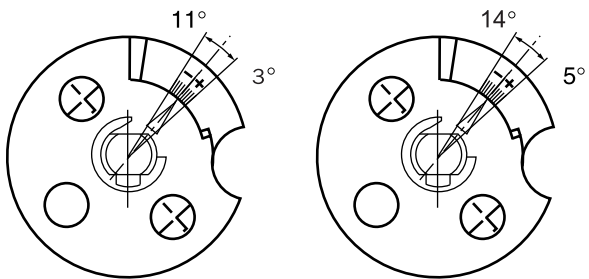

## SICK AT A GLANCE

SICK is one of the leading manufacturers of intelligent sensors and sensor solutions for industrial applications. A unique range of products and services creates the perfect basis for controlling processes securely and efficiently, protecting individuals from accidents and preventing damage to the environment.

We have extensive experience in a wide range of industries and understand their processes and requirements. With intelligent sensors, we can deliver exactly what our customers need. In application centers in Europe, Asia and North America, system solutions are tested and optimized in accordance with customer specifications. All this makes us a reliable supplier and development partner.

Comprehensive services complete our offering: SICK LifeTime Services provide support throughout the machine life cycle and ensure safety and productivity.

For us, that is “Sensor Intelligence.”

## WORLDWIDE PRESENCE:

Contacts and other locations –[www.sick.com](http://www.sick.com)