



# VT18-2T1152

V18

PHOTOELECTRIC SENSORS

**SICK**  
Sensor Intelligence.



### Ordering information

Type	part no.
VT18-2T1152	6011372

Other models and accessories → [www.sick.com/V18](http://www.sick.com/V18)

Illustration may differ



### Detailed technical data

#### Features

<b>Functional principle</b>	Photoelectric proximity sensor
<b>Functional principle detail</b>	Energetic
<b>Dimensions (W x H x D)</b>	18 mm x 18 mm x 88 mm
<b>Housing design (light emission)</b>	Cylindrical
<b>Housing length</b>	88 mm
<b>Thread diameter (housing)</b>	M18 x 1
<b>Optical axis</b>	Axial
<b>Sensing range max.</b>	2 mm ... 400 mm <sup>1)</sup>
<b>Sensing range</b>	3 mm ... 360 mm
<b>Focus</b>	Approx. 3.5°
<b>Type of light</b>	Infrared light
<b>Light source</b>	LED <sup>2)</sup>
<b>Light spot size (distance)</b>	Ø 48 mm (400 mm)
<b>Angle of dispersion</b>	Approx. 3.5°
<b>Adjustment</b>	None

<sup>1)</sup> Object with 90% remission (based on standard white, DIN 5033).

<sup>2)</sup> Average service life: 100,000 h at T<sub>U</sub> = +25 °C.

## Mechanics/electronics

<b>Supply voltage <math>U_B</math></b>	20 V AC ... 253 V AC <sup>1)</sup>
<b>Mains frequency</b>	50 Hz, 60 Hz
<b>Current consumption</b>	30 mA <sup>2)</sup>
<b>Switching output</b>	TRIAC
<b>Switching mode</b>	Light switching
<b>Output current <math>I_{max}</math></b>	≤ 300 mA <sup>3)</sup>
<b>Response time</b>	≤ 20 ms <sup>4)</sup>
<b>Switching frequency</b>	25 Hz <sup>5)</sup>
<b>Connection type</b>	Cable, 3-wire, 2 m <sup>6)</sup>
<b>Cable material</b>	Plastic, PVC
<b>Conductor cross section</b>	0.34 mm <sup>2</sup>
<b>Cable diameter</b>	Ø 4.7 mm
<b>Circuit protection</b>	C <sup>7)</sup>
<b>Protection class</b>	II
<b>Weight</b>	95 g
<b>Housing material</b>	Plastic, PBT/PC
<b>Optics material</b>	Plastic, PMMA
<b>Enclosure rating</b>	IP67
<b>Ambient operating temperature</b>	-25 °C ... +70 °C
<b>UL File No.</b>	NMFT2.E175606

<sup>1)</sup> Limit values.

<sup>2)</sup> Without load.

<sup>3)</sup> Depending on supply voltage VS.

<sup>4)</sup> Signal transit time with resistive load.

<sup>5)</sup> With light/dark ratio 1:1.

<sup>6)</sup> Do not bend below 0 °C.

<sup>7)</sup> C = interference suppression.

## Certificates

<b>EU declaration of conformity</b>	✓
<b>UK declaration of conformity</b>	✓
<b>ACMA declaration of conformity</b>	✓
<b>Moroccan declaration of conformity</b>	✓
<b>China RoHS</b>	✓
<b>cRUus certificate</b>	✓

## Classifications

<b>ECLASS 5.0</b>	27270903
<b>ECLASS 5.1.4</b>	27270903
<b>ECLASS 6.0</b>	27270903
<b>ECLASS 6.2</b>	27270903
<b>ECLASS 7.0</b>	27270903
<b>ECLASS 8.0</b>	27270903

<b>ECLASS 8.1</b>	27270903
<b>ECLASS 9.0</b>	27270903
<b>ECLASS 10.0</b>	27270904
<b>ECLASS 11.0</b>	27270904
<b>ECLASS 12.0</b>	27270903
<b>ETIM 5.0</b>	EC001821
<b>ETIM 6.0</b>	EC001821
<b>ETIM 7.0</b>	EC002719
<b>ETIM 8.0</b>	EC002719
<b>UNSPSC 16.0901</b>	39121528

### Connection type

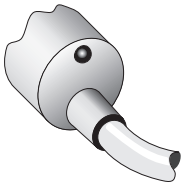

### Connection diagram Cd-063

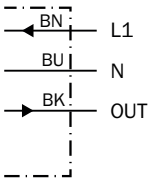

Characteristic curve

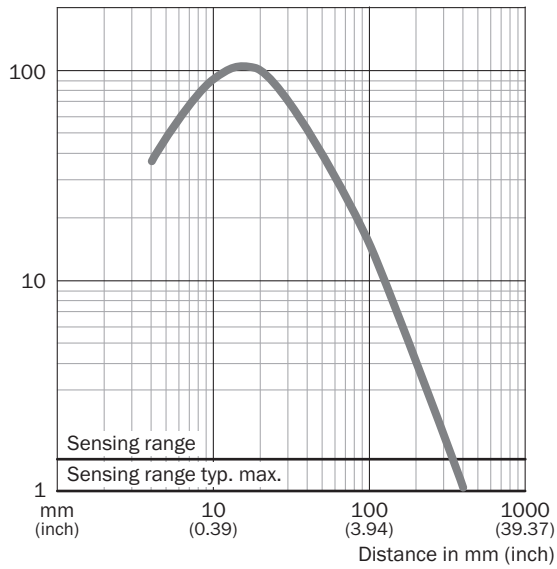

Dimensional drawing

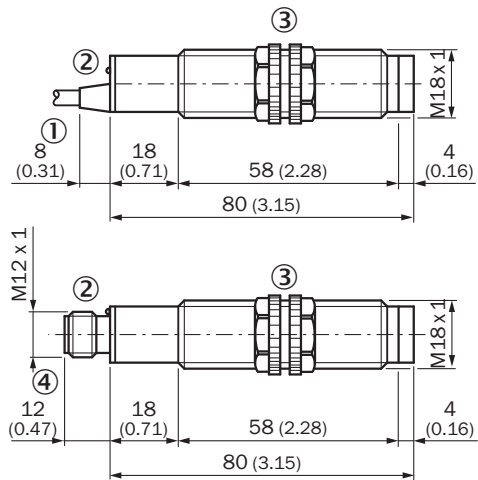



Dimensions in mm (inch)

- ① Connection cable
- ② LED signal strength indicator
- ③ Fastening nuts, 22 mm hex (included)
- ④ Connector M12, 4-pin

Recommended accessories

Other models and accessories → [www.sick.com/V18](http://www.sick.com/V18)

	Brief description	Type	part no.
Mounting systems			
	<ul style="list-style-type: none"> <li><b>Description:</b> Mounting bracket for M18 sensors</li> <li><b>Material:</b> Steel</li> <li><b>Details:</b> Steel, zinc coated</li> <li><b>Items supplied:</b> Without mounting hardware</li> <li><b>Suitable for:</b> GR18, V180-2, V18, W15, Z1, Z2</li> </ul>	BEF-WN-M18	5308446
	<ul style="list-style-type: none"> <li><b>Description:</b> Plate N11N for universal clamp bracket</li> <li><b>Material:</b> Stainless steel</li> <li><b>Details:</b> Stainless steel 1.4571 (sheet), Stainless steel 1.4408 (clamp)</li> <li><b>Items supplied:</b> Universal clamp (5322627), mounting hardware</li> <li><b>Usable for:</b> DeltaPac, Glare, WTD20E</li> </ul>	BEF-KHS-N11N	2071081
connectors and cables			
	<ul style="list-style-type: none"> <li><b>Connection type head A:</b> Male connector, M8, 3-pin, straight, A-coded</li> <li><b>Description:</b> Unshielded</li> <li><b>Connection systems:</b> Screw-type terminals</li> <li><b>Permitted cross-section:</b> 0.14 mm<sup>2</sup> ... 0.5 mm<sup>2</sup></li> </ul>	STE-0803-G	6037322

## SICK AT A GLANCE

SICK is one of the leading manufacturers of intelligent sensors and sensor solutions for industrial applications. A unique range of products and services creates the perfect basis for controlling processes securely and efficiently, protecting individuals from accidents and preventing damage to the environment.

We have extensive experience in a wide range of industries and understand their processes and requirements. With intelligent sensors, we can deliver exactly what our customers need. In application centers in Europe, Asia and North America, system solutions are tested and optimized in accordance with customer specifications. All this makes us a reliable supplier and development partner.

Comprehensive services complete our offering: SICK LifeTime Services provide support throughout the machine life cycle and ensure safety and productivity.

For us, that is “Sensor Intelligence.”

## WORLDWIDE PRESENCE:

Contacts and other locations –[www.sick.com](http://www.sick.com)