



DOL-1205-G05M

Sensor-actuator cables

CONNECTORS AND CABLES

SICK
Sensor Intelligence.



Illustration may differ

Ordering information

Type	part no.
DOL-1205-G05M	6009868

Other models and accessories → www.sick.com/Sensor-actuator_cables

Detailed technical data

Technical specifications

Connection type head A	Female connector, M12, 5-pin, straight
Connection type head B	Flying leads
Connection type	Flying leads
Connector material	TPU
Connector color	Orange
Locking nut material	Nickel-plated brass
Tightening torque	0.5 Nm
Cable	5 m, 5-wire, PVC
Jacket material	PVC
Jacket color	Orange
Cable diameter	5.7 mm
Conductor cross section	0.34 mm ²
Shielding	Unshielded
Bending radius	
Flexible use	> 10 x cable diameter
Stationary position	> 5 x cable diameter
Bending cycles	≥ 1,000,000
Reference voltage	≤ 60 V
Current loading	4 A
Signal type	Sensor/actuator cable
Application	Zones with chemicals
Enclosure rating	IP67
Operating temperature	
Flexible use	+5 °C ... +80 °C
Stationary position	-40 °C ... +80 °C
Head	-25 °C ... +80 °C

Classifications

ECLASS 5.0	19030312
ECLASS 5.1.4	19030312

ECLASS 6.0	27060304
ECLASS 6.2	27060304
ECLASS 7.0	27060304
ECLASS 8.0	27060304
ECLASS 8.1	27060304
ECLASS 9.0	27060304
ECLASS 10.0	27060304
ECLASS 11.0	27060304
ECLASS 12.0	27060304
ETIM 5.0	EC000830
ETIM 6.0	EC000830
ETIM 7.0	EC003249
ETIM 8.0	EC003249
UNSPSC 16.0901	26121604

Dimensional drawing

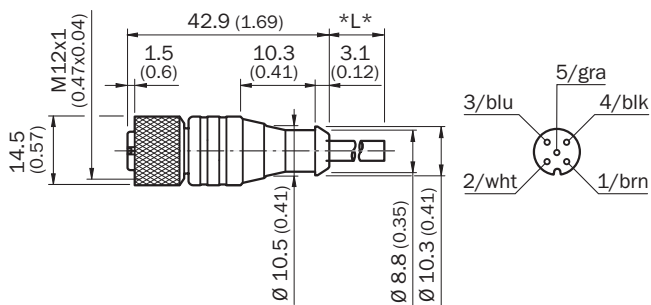

Dimensions in mm (inch)

SICK AT A GLANCE

SICK is one of the leading manufacturers of intelligent sensors and sensor solutions for industrial applications. A unique range of products and services creates the perfect basis for controlling processes securely and efficiently, protecting individuals from accidents and preventing damage to the environment.

We have extensive experience in a wide range of industries and understand their processes and requirements. With intelligent sensors, we can deliver exactly what our customers need. In application centers in Europe, Asia and North America, system solutions are tested and optimized in accordance with customer specifications. All this makes us a reliable supplier and development partner.

Comprehensive services complete our offering: SICK LifeTime Services provide support throughout the machine life cycle and ensure safety and productivity.

For us, that is “Sensor Intelligence.”

WORLDWIDE PRESENCE:

Contacts and other locations –www.sick.com