



GS6-P0321S71

G6

PHOTOELECTRIC SENSORS

SICK
Sensor Intelligence.



Illustration may differ



Ordering information

Type	part no.
GS6-P0321S71	2119995

Other models and accessories → www.sick.com/G6

Detailed technical data

Features

Functional principle	Through-beam photoelectric sensor
Sensing range max.	0 m ... 14.5 m
Sensing range	0 m ... 10.6 m
Polarisation filter	No
Emitted beam	Light source
	Type of light
Key LED figures	LED ¹⁾
	Wave length
Adjustment	None
Special features	Sender only. For use with GE6-P0321S71, 2119996
Part number of individual components	2080269 GS6-D1321S54 2084042 GE6-P1321S56

¹⁾ Average service life: 100,000 h at T_J = +25 °C.

Safety-related parameters

MTTF_D	1,193 years
DC_{avg}	0 %

Electronics

Supply voltage U_B	10 V DC ... 30 V DC ¹⁾
Ripple	$\pm 10\%$ ²⁾
Current consumption	30 mA ³⁾
Protection class	III
Digital output	
Output current I_{max}	$\leq 100\text{ mA}$ ⁴⁾
Response time	$< 500\ \mu\text{s}$ ⁵⁾
Switching frequency	1,000 Hz ⁶⁾
Circuit protection	A ⁷⁾ B ⁸⁾ D ⁹⁾
Special feature	Sender

¹⁾ Limit values when operated in short-circuit protected network: max. 8 A.

²⁾ May not fall below or exceed U_y tolerances.

³⁾ Without load.

⁴⁾ At $U_v > 24\text{ V}$, $I_A\text{ max.} = 50\text{ mA}$.

⁵⁾ Signal transit time with resistive load.

⁶⁾ With light/dark ratio 1:1.

⁷⁾ A = V_S connections reverse-polarity protected.

⁸⁾ B = inputs and output reverse-polarity protected.

⁹⁾ D = outputs overcurrent and short-circuit protected.

Mechanics

Housing	Rectangular
Dimensions (W x H x D)	12 mm x 31.5 mm x 21 mm
Connection	Cable, 3-wire, 500 mm ¹⁾
Connection detail	
Conductor size	0.14 mm ²
Length of cable (L)	500 mm ¹⁾
Material	
Housing	Plastic, ABS/PC
Front screen	Plastic, PMMA
Cable	Plastic, PVC
Weight	Approx. 20 g

¹⁾ Do not bend below 0 °C.

Ambient data

Enclosure rating	IP67
Ambient operating temperature	-25 °C ... +55 °C ¹⁾
Ambient temperature, storage	-40 °C ... +70 °C
UL File No.	NRKH.E348498 & NRKH7.E348498

¹⁾ Temperature stability following adjustment +/-10 °C.

Certificates

EU declaration of conformity	✓
UK declaration of conformity	✓
ACMA declaration of conformity	✓
Moroccan declaration of conformity	✓
China RoHS	✓
cULus certificate	✓
Photobiological safety (DIN EN 62471) certificate	✓

Classifications

ECLASS 5.0	27270901
ECLASS 5.1.4	27270901
ECLASS 6.0	27270901
ECLASS 6.2	27270901
ECLASS 7.0	27270901
ECLASS 8.0	27270901
ECLASS 8.1	27270901
ECLASS 9.0	27270901
ECLASS 10.0	27270901
ECLASS 11.0	27270901
ECLASS 12.0	27270901
ETIM 5.0	EC002716
ETIM 6.0	EC002716
ETIM 7.0	EC002716
ETIM 8.0	EC002716
UNSPSC 16.0901	39121528

Dimensional drawing

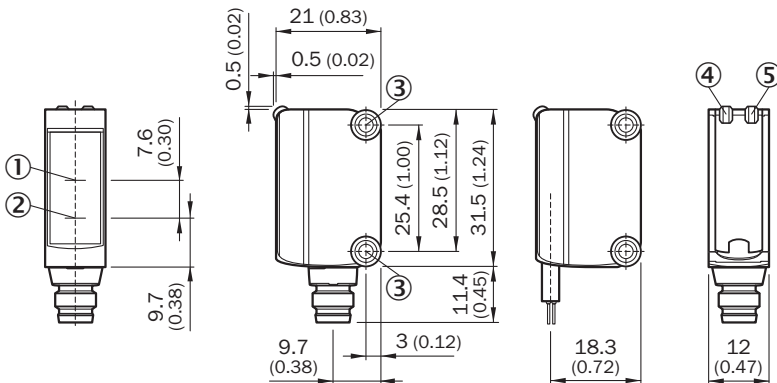

Dimensions in mm (inch)

- ① Optical axis, receiver
- ② Optical axis, sender

- ③ Mounting holes \varnothing 3 mm
- ④ LED indicator green: Supply voltage active
- ⑤ LED indicator yellow: Status of received light beam

Adjustments No adjustment possibility



- ④ LED indicator green: Supply voltage active
- ⑤ LED indicator yellow: Status of received light beam

Connection type

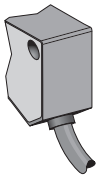

Connection diagram Cd-047

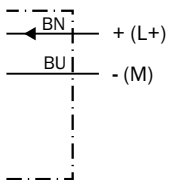

Characteristic curve GE6-P0321S71, GS6-P0321S71



Light spot size

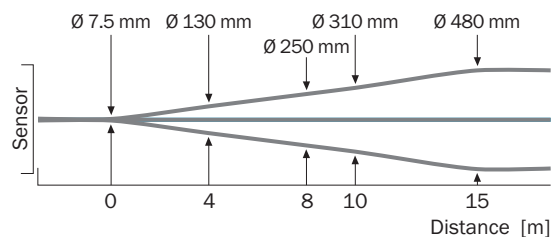

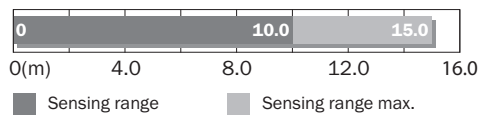

Sensing range diagram GE6-P0321S71, GS6-P0321S71



Recommended accessories

Other models and accessories → www.sick.com/G6

	Brief description	Type	part no.
Mounting systems			
	<ul style="list-style-type: none"> Description: Clamp bar to fix G6 sensors on rods of 12 mm, clamp-on design up to 4 mm wall thickness Material: Steel Details: Aluminum (clamp bar), stainless steel (bracket) Items supplied: Clamp bar mounting and clamp function, mounting bracket, mounting hardware 	BEF-KHS-IS12G6	2086865
	<ul style="list-style-type: none"> Material: Stainless steel Details: Stainless steel (1.4301) Suitable for: W4S, W4S 	BEF-WN-G6	2062909
	<ul style="list-style-type: none"> Description: Mounting bracket for wall mounting Material: Stainless steel Details: Stainless steel Items supplied: Mounting hardware included Suitable for: W8, W8G, W8 Laser, W8 Inox, G6, G6 Inox, W100 Laser, W100-2, KTM Core, KTM Prime, CSM, LUTM, W4S 	BEF-W100-A	5311520

SICK AT A GLANCE

SICK is one of the leading manufacturers of intelligent sensors and sensor solutions for industrial applications. A unique range of products and services creates the perfect basis for controlling processes securely and efficiently, protecting individuals from accidents and preventing damage to the environment.

We have extensive experience in a wide range of industries and understand their processes and requirements. With intelligent sensors, we can deliver exactly what our customers need. In application centers in Europe, Asia and North America, system solutions are tested and optimized in accordance with customer specifications. All this makes us a reliable supplier and development partner.

Comprehensive services complete our offering: SICK LifeTime Services provide support throughout the machine life cycle and ensure safety and productivity.

For us, that is “Sensor Intelligence.”

WORLDWIDE PRESENCE:

Contacts and other locations –www.sick.com