



VLR-263RA4011

Illuminations

REFLECTORS AND OPTICS

SICK
Sensor Intelligence.



Illustration may differ

Ordering information

Type	part no.
VLR-263RA4011	2118269

Other models and accessories → www.sick.com/Illuminations

Detailed technical data

Features

Product segment	Reflectors and optics
Product	Illuminations
Product version	LED
Description	Ring illumination unit with shallow illumination angle
Light source	LED, red, 630 nm
LED class	Risk group 1 (low risk, IEC62471 : 2008)
Power consumption	≤ 5 W
Supply voltage	24 V DC
Power consumption	0.18 A
Connections	Connector M12, 4-pin, L = 0.5 m
Ambient operating temperature	0 °C ... +40 °C ¹⁾
Storage temperature	-20 °C ... +60 °C

¹⁾ Light intensity may vary depending on the ambient temperature.

Classifications

ECLASS 5.0	27110635
ECLASS 5.1.4	27110635
ECLASS 6.0	27110635
ECLASS 6.2	27110635
ECLASS 7.0	27110635
ECLASS 8.0	27110635
ECLASS 8.1	27110635
ECLASS 9.0	27110635
ECLASS 10.0	27110635
ECLASS 11.0	27110635
ECLASS 12.0	27110635
ETIM 5.0	EC000996
ETIM 6.0	EC000996
ETIM 7.0	EC000996
ETIM 8.0	EC000996
UNSPSC 16.0901	39101628

Dimensional drawing

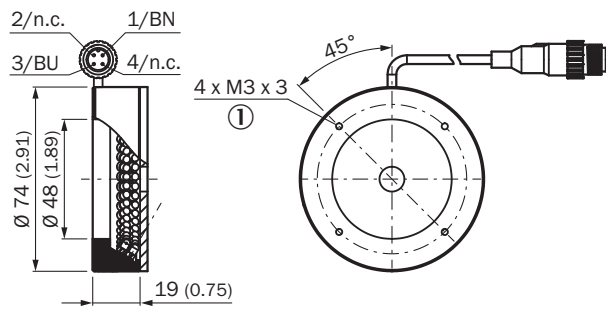

Dimensions in mm (inch)

① For installation; pitch circle diameter 60 mm

SICK AT A GLANCE

SICK is one of the leading manufacturers of intelligent sensors and sensor solutions for industrial applications. A unique range of products and services creates the perfect basis for controlling processes securely and efficiently, protecting individuals from accidents and preventing damage to the environment.

We have extensive experience in a wide range of industries and understand their processes and requirements. With intelligent sensors, we can deliver exactly what our customers need. In application centers in Europe, Asia and North America, system solutions are tested and optimized in accordance with customer specifications. All this makes us a reliable supplier and development partner.

Comprehensive services complete our offering: SICK LifeTime Services provide support throughout the machine life cycle and ensure safety and productivity.

For us, that is “Sensor Intelligence.”

WORLDWIDE PRESENCE:

Contacts and other locations –www.sick.com