



Protective housing spare part, deTec IP69K

Protective housing

DEVICE PROTECTION AND CARE

SICK
Sensor Intelligence.



Ordering information

Type	part no.
Protective housing spare part, deTec IP69K	2096393

Other models and accessories → www.sick.com/Protective_housing

Detailed technical data

Features

Product segment	Device protection and care
Product	Protective housing
Description	Suitable for protective field height of 1,650 mm

Classifications

ECLASS 5.0	27270991
ECLASS 5.1.4	27270991
ECLASS 6.0	27279102
ECLASS 6.2	27279102
ECLASS 7.0	27279102
ECLASS 8.0	27279102
ECLASS 8.1	27279102
ECLASS 9.0	27270991
ECLASS 10.0	27270991
ECLASS 11.0	27270991
ECLASS 12.0	27270991
ETIM 5.0	EC001855
ETIM 6.0	EC001855
ETIM 7.0	EC001855
ETIM 8.0	EC001855
UNSPSC 16.0901	26121606

Dimensional drawing

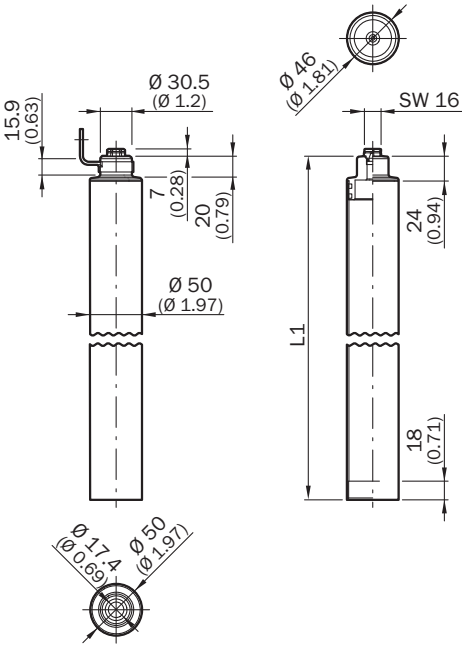

Dimensions in mm (inch)

-	L	-
300	397	-
450	547	-
600	698	-
750	848	-
900	998	-
1,050	1,149	-
1,200	1,299	-
1,350	1,449	-
1,500	1,599	-
1,650	1,750	-
1,800	1,900	-
-	-	-
-	-	L
2	500	757
3	400	1,058
4	300	1,158

SICK AT A GLANCE

SICK is one of the leading manufacturers of intelligent sensors and sensor solutions for industrial applications. A unique range of products and services creates the perfect basis for controlling processes securely and efficiently, protecting individuals from accidents and preventing damage to the environment.

We have extensive experience in a wide range of industries and understand their processes and requirements. With intelligent sensors, we can deliver exactly what our customers need. In application centers in Europe, Asia and North America, system solutions are tested and optimized in accordance with customer specifications. All this makes us a reliable supplier and development partner.

Comprehensive services complete our offering: SICK LifeTime Services provide support throughout the machine life cycle and ensure safety and productivity.

For us, that is “Sensor Intelligence.”

WORLDWIDE PRESENCE:

Contacts and other locations –www.sick.com