



# Protective housing spare part, deTec IP69K

Protective housing

DEVICE PROTECTION AND CARE

**SICK**  
Sensor Intelligence.



### Ordering information

Type	part no.
Protective housing spare part, deTec IP69K	2096388

Other models and accessories → [www.sick.com/Protective\\_housing](http://www.sick.com/Protective_housing)

### Detailed technical data

#### Features

<b>Product segment</b>	Device protection and care
<b>Product</b>	Protective housing
<b>Description</b>	Suitable for protective field height of 900 mm

#### Classifications

<b>ECLASS 5.0</b>	27270991
<b>ECLASS 5.1.4</b>	27270991
<b>ECLASS 6.0</b>	27279102
<b>ECLASS 6.2</b>	27279102
<b>ECLASS 7.0</b>	27279102
<b>ECLASS 8.0</b>	27279102
<b>ECLASS 8.1</b>	27279102
<b>ECLASS 9.0</b>	27270991
<b>ECLASS 10.0</b>	27270991
<b>ECLASS 11.0</b>	27270991
<b>ECLASS 12.0</b>	27270991
<b>ETIM 5.0</b>	EC001855
<b>ETIM 6.0</b>	EC001855
<b>ETIM 7.0</b>	EC001855
<b>ETIM 8.0</b>	EC001855
<b>UNSPSC 16.0901</b>	26121606

Dimensional drawing

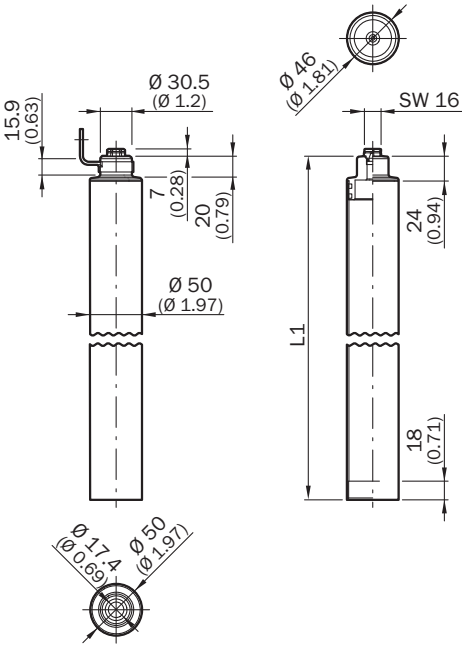

Dimensions in mm (inch)

-	L	-
300	397	-
450	547	-
600	698	-
750	848	-
900	998	-
1,050	1,149	-
1,200	1,299	-
1,350	1,449	-
1,500	1,599	-
1,650	1,750	-
1,800	1,900	-
-	-	-
-	-	L
2	500	757
3	400	1,058
4	300	1,158

## SICK AT A GLANCE

SICK is one of the leading manufacturers of intelligent sensors and sensor solutions for industrial applications. A unique range of products and services creates the perfect basis for controlling processes securely and efficiently, protecting individuals from accidents and preventing damage to the environment.

We have extensive experience in a wide range of industries and understand their processes and requirements. With intelligent sensors, we can deliver exactly what our customers need. In application centers in Europe, Asia and North America, system solutions are tested and optimized in accordance with customer specifications. All this makes us a reliable supplier and development partner.

Comprehensive services complete our offering: SICK LifeTime Services provide support throughout the machine life cycle and ensure safety and productivity.

For us, that is “Sensor Intelligence.”

## WORLDWIDE PRESENCE:

Contacts and other locations –[www.sick.com](http://www.sick.com)