



GE2S-P1321

G2

PHOTOELECTRIC SENSORS

SICK
Sensor Intelligence.



Illustration may differ



Ordering information

Type	part no.
GE2S-P1321	2095646

Other models and accessories → www.sick.com/G2

Detailed technical data

Features

Functional principle	Through-beam photoelectric sensor
Dimensions (W x H x D)	7.7 mm x 21.8 mm x 13.5 mm
Housing design (light emission)	Rectangular
Sensing range max.	0 m ... 3 m
Sensing range	0 m ... 2 m
Adjustment	None
Special feature	Receiver
Special features	Through-beam photoelectric sensor (receiver only)

Mechanics/electronics

Supply voltage U_B	10 V DC ... 30 V DC ¹⁾
Ripple	< 5 V _{pp} ²⁾
Current consumption	20 mA ³⁾
Switching output	PNP
Switching mode	Light switching
Output current I_{max}	≤ 50 mA
Response time	< 0.6 ms ⁴⁾

¹⁾ Limit values when operated in short-circuit protected network: max. 8 A.

²⁾ May not fall below or exceed U_V tolerances.

³⁾ Without load.

⁴⁾ Signal transit time with resistive load.

⁵⁾ With light/dark ratio 1:1.

⁶⁾ Do not bend below 0 °C.

⁷⁾ A = V_S connections reverse-polarity protected.

⁸⁾ C = interference suppression.

⁹⁾ D = outputs overcurrent and short-circuit protected.

Switching frequency	800 Hz ⁵⁾
Connection type	Cable, 3-wire, 2 m ⁶⁾
Cable material	Plastic, PVC
Cable diameter	Ø 3 mm
Circuit protection	A ⁷⁾ C ⁸⁾ D ⁹⁾
Weight	33.7 g
Housing material	Plastic, ABS
Optics material	Plastic, PMMA
Enclosure rating	IP67
Special feature	Receiver
Ambient operating temperature	-25 °C ... +50 °C
Ambient temperature, storage	-40 °C ... +75 °C
UL File No.	NRKH.E181493

- 1) Limit values when operated in short-circuit protected network: max. 8 A.
 2) May not fall below or exceed U_y tolerances.
 3) Without load.
 4) Signal transit time with resistive load.
 5) With light/dark ratio 1:1.
 6) Do not bend below 0 °C.
 7) A = V_S connections reverse-polarity protected.
 8) C = interference suppression.
 9) D = outputs overcurrent and short-circuit protected.

Certificates

EU declaration of conformity	✓
UK declaration of conformity	✓
ACMA declaration of conformity	✓
Moroccan declaration of conformity	✓
China RoHS	✓
cULus certificate	✓
Photobiological safety (DIN EN 62471) certificate	✓

Classifications

ECLASS 5.0	27270901
ECLASS 5.1.4	27270901
ECLASS 6.0	27270901
ECLASS 6.2	27270901
ECLASS 7.0	27270901
ECLASS 8.0	27270901
ECLASS 8.1	27270901
ECLASS 9.0	27270901
ECLASS 10.0	27270901

ECLASS 11.0	27270901
ECLASS 12.0	27270901
ETIM 5.0	EC002716
ETIM 6.0	EC002716
ETIM 7.0	EC002716
ETIM 8.0	EC002716
UNSPSC 16.0901	39121528

Connection type

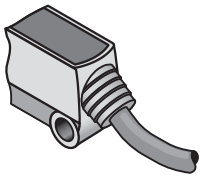

Connection diagram Cd-061

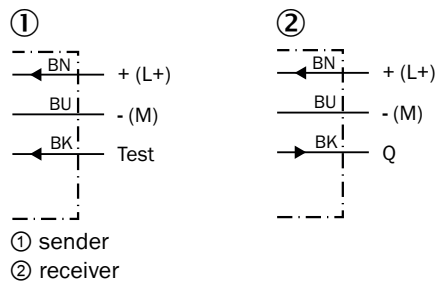

Characteristic curve

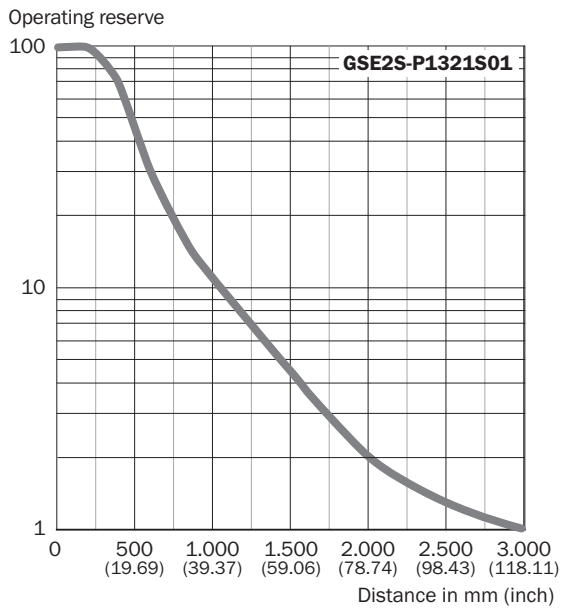

Light spot size

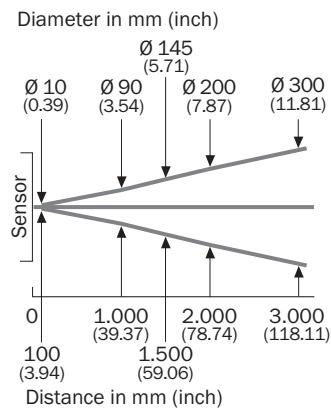

Sensing range diagram

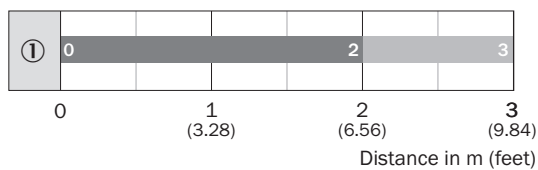

■ Sensing range ■ Sensing range max.

① R = 6 %

Dimensional drawing GSE2S

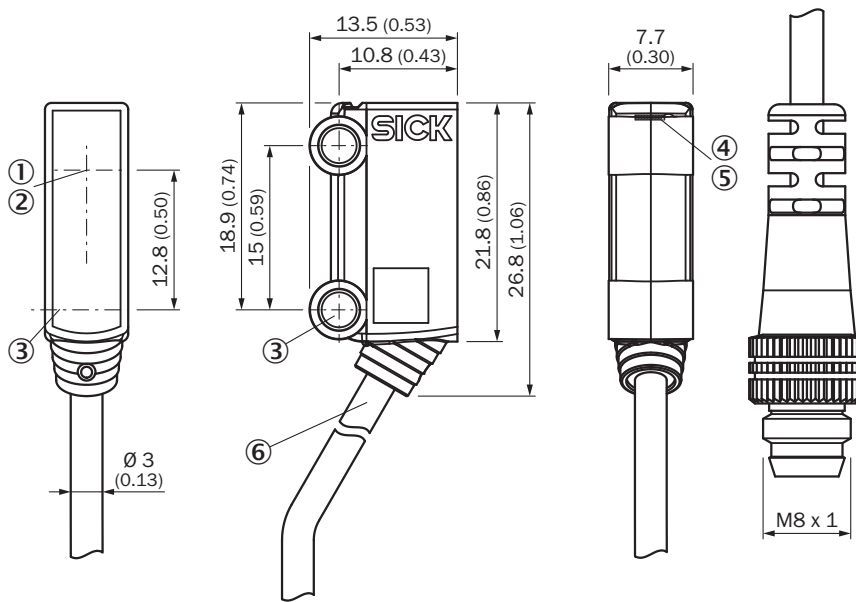



Dimensions in mm (inch)

- ① optical axis, receiver
- ② optical axis, sender
- ③ Mounting hole, Ø 3.2 mm
- ④ LED indicator green: Supply voltage active
- ⑤ LED indicator yellow: Status of received light beam
- ⑥ Connection

Recommended accessories

Other models and accessories → www.sick.com/G2

	Brief description	Type	part no.
Mounting systems			
	<ul style="list-style-type: none"> • Description: Mounting bracket for floor mounting • Material: Steel • Details: Steel, zinc coated • Items supplied: Without mounting hardware • Suitable for: W2S-2 	BEF-W2S-A	4034748
connectors and cables			
	<ul style="list-style-type: none"> • Description: Unshielded • Connection type head A: Male connector, M8, 3-pin, straight, A-coded • Connection systems: Screw-type terminals • Permitted cross-section: 0.14 mm² ... 0.5 mm² 	STE-0803-G	6037322

SICK AT A GLANCE

SICK is one of the leading manufacturers of intelligent sensors and sensor solutions for industrial applications. A unique range of products and services creates the perfect basis for controlling processes securely and efficiently, protecting individuals from accidents and preventing damage to the environment.

We have extensive experience in a wide range of industries and understand their processes and requirements. With intelligent sensors, we can deliver exactly what our customers need. In application centers in Europe, Asia and North America, system solutions are tested and optimized in accordance with customer specifications. All this makes us a reliable supplier and development partner.

Comprehensive services complete our offering: SICK LifeTime Services provide support throughout the machine life cycle and ensure safety and productivity.

For us, that is “Sensor Intelligence.”

WORLDWIDE PRESENCE:

Contacts and other locations –www.sick.com