



## Connection cable

Other connectors and cables

CONNECTORS AND CABLES

**SICK**  
Sensor Intelligence.



### Ordering information

Type	part no.
Connection cable	2094427

Other models and accessories → [www.sick.com/Other\\_connectors\\_and\\_cables](http://www.sick.com/Other_connectors_and_cables)



### Detailed technical data

#### Technical specifications

<b>Connection type head A</b>	Male connector, Micro D-Sub, 15-pin, angled
<b>Connection type head B</b>	Female connector, M12, 8-pin, straight, A-coded
<b>Cable</b>	5 m
<b>Shielding</b>	Shielded
<b>Reference voltage</b>	300 V AC

#### Certificates

<b>EU declaration of conformity</b>	✓
<b>UK declaration of conformity</b>	✓

#### Classifications

<b>ECLASS 5.0</b>	19030312
<b>ECLASS 5.1.4</b>	19030312
<b>ECLASS 6.0</b>	27060304
<b>ECLASS 6.2</b>	27060304
<b>ECLASS 7.0</b>	27060304
<b>ECLASS 8.0</b>	27060304
<b>ECLASS 8.1</b>	27060304
<b>ECLASS 9.0</b>	27060304
<b>ECLASS 10.0</b>	27060304
<b>ECLASS 11.0</b>	27060304
<b>ECLASS 12.0</b>	27060304
<b>ETIM 5.0</b>	EC000830
<b>ETIM 6.0</b>	EC000830
<b>ETIM 7.0</b>	EC003249
<b>ETIM 8.0</b>	EC003249
<b>UNSPSC 16.0901</b>	26121604

### Dimensional drawing (Incl. table pin assignment from Head A (X1) to Head B (X2) for various encoder types)

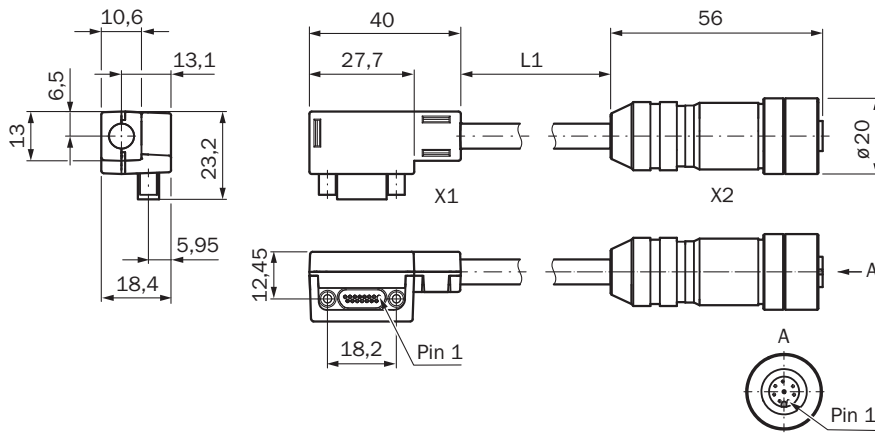

Dimensions in mm (inch)

X1		X2						
Male connector, Micro D-Sub, 15-pin		Female connector M12, 8-pin, A-coded						
FX3-MOC		Encoder	Sin/cos encoder		A/B incremental encoder			
Pin	Designation	Pin	Sin/Cos	HIPERFACE®	2 output pairs (HTL 24 V, HTL 12 V, TTL)	2 outputs (HTL 24 V, HTL 12 V, TTL)	2 output pairs (RS-422)	
1	ENC1_A+	2	Cos+	Cos	A+	A	A+	
2	ENC1_B+	4	Sin+	Sin	B+	B	-	
3	ENC1_C+	6	Z+	-	-	-	B+	
4	ENC1_24V	8	24 V supply voltage					
9	ENC1_A-	1	Cos-	Cos_Ref	A-	GND	A-	
10	ENC1_B-	3	Sin-	Sin_Ref	B-	GND	-	
11	ENC1_C-	5	Z-	-	-	-	B-	
12	ENC_OV	7	GND supply voltage					

### Head A (X1): Plug, Micro D-SUB, 15-pin (incl. table pin assignment from X1 to X2 for various encoder types)

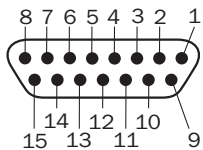

X1		X2					
Male connector, Micro D-Sub, 15-pin		Female connector M12, 8-pin, A-coded					
FX3-MOC		Encoder	Sin/cos encoder		A/B incremental encoder		
Pin	Designation	Pin	Sin/Cos	HIPERFACE®	2 output pairs (HTL 24 V, HTL 12 V, TTL)	2 outputs (HTL 24 V, HTL 12 V, TTL)	2 output pairs (RS-422)
1	ENC1_A+	2	Cos+	Cos	A+	A	A+
2	ENC1_B+	4	Sin+	Sin	B+	B	-

X1			X2				
3	ENC1_C+	6	Z+	-	-	-	B+
4	ENC1_24V	8	24 V supply voltage				
9	ENC1_A-	1	Cos-	Cos_Ref	A-	GND	A-
10	ENC1_B-	3	Sin-	Sin_Ref	B-	GND	-
11	ENC1_C-	5	Z-	-	-	-	B-
12	ENC_OV	7	GND supply voltage				

Head B (X2): Socket, M12, 8-pin (incl. table pin assignment from X1 to X2 for various encoder types)

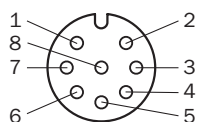

X1		X2					
Male connector, Micro D-Sub, 15-pin		Female connector M12, 8-pin, A-coded					
FX3-MOC		Encoder	Sin/cos encoder		A/B incremental encoder		
Pin	Designation	Pin	Sin/Cos	HIPERFACE®	2 output pairs (HTL 24 V, HTL 12 V, TTL)	2 outputs (HTL 24 V, HTL 12 V, TTL)	2 output pairs (RS-422)
1	ENC1_A+	2	Cos+	Cos	A+	A	A+
2	ENC1_B+	4	Sin+	Sin	B+	B	-
3	ENC1_C+	6	Z+	-	-	-	B+
4	ENC1_24V	8	24 V supply voltage				
9	ENC1_A-	1	Cos-	Cos_Ref	A-	GND	A-
10	ENC1_B-	3	Sin-	Sin_Ref	B-	GND	-
11	ENC1_C-	5	Z-	-	-	-	B-
12	ENC_OV	7	GND supply voltage				

## SICK AT A GLANCE

SICK is one of the leading manufacturers of intelligent sensors and sensor solutions for industrial applications. A unique range of products and services creates the perfect basis for controlling processes securely and efficiently, protecting individuals from accidents and preventing damage to the environment.

We have extensive experience in a wide range of industries and understand their processes and requirements. With intelligent sensors, we can deliver exactly what our customers need. In application centers in Europe, Asia and North America, system solutions are tested and optimized in accordance with customer specifications. All this makes us a reliable supplier and development partner.

Comprehensive services complete our offering: SICK LifeTime Services provide support throughout the machine life cycle and ensure safety and productivity.

For us, that is “Sensor Intelligence.”

## WORLDWIDE PRESENCE:

Contacts and other locations –[www.sick.com](http://www.sick.com)