



SP1-1100

System plugs deTec and deTem

SYSTEM PLUGS AND EXTENSION MODULES

SICK
Sensor Intelligence.



Illustration may differ

Ordering information

Type	part no.
SP1-1100	2076833

Other models and accessories → www.sick.com/System_plugs_deTec_and_deTem



Detailed technical data

Features

Compatible devices	deTec4, deTem4, deTem4 A/P
Function range	SP1
System connection	Plug, M12, 5-pin
Extension connection	Female connector M12, 5-pin
IO-Link possible on the extension connection	✓
Configuration method	DIP switch
Items supplied	System plug

Functions

Protective operation	✓
Automatic calibration of the protective field width	✓
Restart interlock	✓
External device monitoring (EDM)	✓
Application diagnostic output (ADO)	✓
Cascading	✓

Interfaces

PIN assignment	See table in "Pin assignment" graphic
System connection	Plug, M12, 5-pin
Length of cable	200 mm
Cable diameter	5 mm
Extension connection	Female connector M12, 5-pin
Length of cable	150 mm
Cable diameter	5 mm

Electronics

Protection class	III (IEC 61140)
Supply voltage V_s	24 V DC (19.2 V ... 28.8 V)
Ripple	≤ 10 %

Ambient data

Ambient operating temperature	-30 °C ... +55 °C
--------------------------------------	-------------------

Storage temperature	-30 °C ... +70 °C
Air humidity	15 % ... 95 %, Non-condensing
Vibration resistance	5 g, 10 Hz ... 55 Hz (IEC 60068-2-6)
Shock resistance	10 g, 16 ms (IEC 60068-2-27)

Classifications

ECLASS 5.0	27272790
ECLASS 5.1.4	27272790
ECLASS 6.0	27272790
ECLASS 6.2	27272790
ECLASS 7.0	27272790
ECLASS 8.0	27272790
ECLASS 8.1	27272790
ECLASS 9.0	27272792
ECLASS 10.0	27272792
ECLASS 11.0	27272792
ECLASS 12.0	27272792
ETIM 5.0	EC011349
ETIM 6.0	EC011349
ETIM 7.0	EC011349
ETIM 8.0	EC011349
UNSPSC 16.0901	46171620

Certificates

EU declaration of conformity	✓
-------------------------------------	---

Dimensional drawing

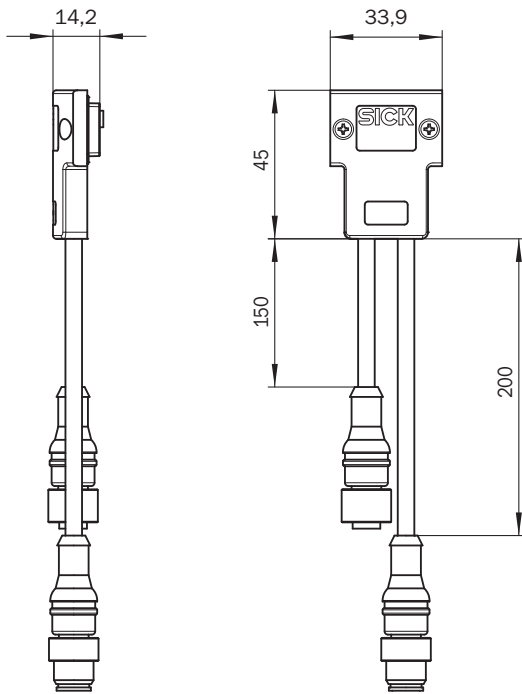

Dimensions in mm (inch)

Pinouts deTem4 A/P extension connection

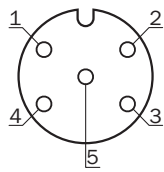

Pin	Active unit
1	+24 V Out
2	In1EDM
3	0 V Out
4	In2RES
5	MFP2ADOIO-Link

For details see operating instructions

Pinouts deTec4 extension connection

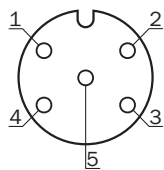

Pin	Sender	Receiver
1	+24 V Out	+24 V Out
2	N. c.	In1EDM
3	0 V Out	0 V Out
4	Sync-Out	In2RES
5	MFP2	MFP2ADOIO-Link
For details see operating instructions		

Pinouts deTem4 A/P system connection

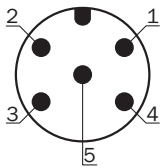

Pin	Active unit
1	+24 V DC
2	OSSD1
3	0 V DC
4	OSSD2
5	N. c.
For details see operating instructions	



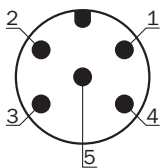



Pinouts deTec4 system connection



Pin	Sender	Receiver
1	+24 V DC	+24 V DC
2	In2Laser alignment aid button	OSSD1
3	0 V DC	0 V DC
4	In1Laser alignment aid switch	OSSD2
5	MFP1	MFP1
For details see operating instructions		

Recommended accessories

Other models and accessories → www.sick.com/System_plugs_deTec_and_deTem

	Brief description	Type	part no.
connectors and cables			
	<ul style="list-style-type: none"> Description: Unshielded Connection type head A: Female connector, M12, 5-pin, A-coded Connection type head B: Female connector, M12, 5-pin, A-coded Connection type head C: Male connector, M12, 5-pin, A-coded 	DSC-1205T000025KMC	6030664
		IO-Link connector	2092757
network devices			
		IOLA2US-01101 (SiLink2 Master)	1061790
		SIG200-0A0G12200	1102605
		SIG200-0A0412200	1089794
		SIG200-0A0512200	1089796

SICK AT A GLANCE

SICK is one of the leading manufacturers of intelligent sensors and sensor solutions for industrial applications. A unique range of products and services creates the perfect basis for controlling processes securely and efficiently, protecting individuals from accidents and preventing damage to the environment.

We have extensive experience in a wide range of industries and understand their processes and requirements. With intelligent sensors, we can deliver exactly what our customers need. In application centers in Europe, Asia and North America, system solutions are tested and optimized in accordance with customer specifications. All this makes us a reliable supplier and development partner.

Comprehensive services complete our offering: SICK LifeTime Services provide support throughout the machine life cycle and ensure safety and productivity.

For us, that is “Sensor Intelligence.”

WORLDWIDE PRESENCE:

Contacts and other locations –www.sick.com