



MAX48C-A3PBDPD0260

MAX

MAGNETOSTRICTIVE LINEAR ENCODERS

SICK
Sensor Intelligence.



Illustration may differ

Ordering information

Type	part no.
MAX48C-A3PBDPD0260	1223177

Other models and accessories → www.sick.com/MAX

Detailed technical data

Features

Additional information	CAT® Part no.: 571-1358
-------------------------------	-------------------------

Safety-related parameters

MTTF_D (mean time to dangerous failure)	69 years (EN ISO 13849-1) ^{1) 2)}
--	--

¹⁾ This product is a standard product and does not constitute a safety component as defined in the Machinery Directive. Calculation based on nominal load of components, average ambient temperature of electronic 60 °C, frequency of use 8760 h/a.

²⁾ Every 2nd failure of an electronic component is considered hazardous.

Performance

Pressure pipe/End cap	10 mm
Connection type	Male connector, M12, 4-pin
Direction of connection	Axial
Measuring range	
Measured values	Positioning
Position (F.S.)	0 mm ... 260 mm ¹⁾
Null zone	30 mm
Damping zone	70.5 mm
Operating conditions	
Air humidity	90 % (Condensation not permitted)
Operating pressure P _N	35 MPa
Supply voltage	9 V DC (7 ... 11 V DC)
Switch-on time	< 150 ms
Switch-on current	Typ. ≤ 140 mA
Measuring frequency (internal)	2 ms
Transmission rate (cycle time)	Type-dependent, according to PWM frequency
Accuracy	
Setpoint tolerance	Typ. ± 0.5 mm
Hysteresis	± 0,1 mm
Repeatability	Typ. ± 0.2 mm
Linearity	≤ ± 0.04% F.S. (min. ≤ ± 0.25 mm)
Temperature drift	
In the operational status	≤ ± 0.04% F.S. (min. ≤ ± 0.25 mm)

¹⁾ F.S. = Full Scale (Measuring range).

Interfaces

Communication interface	PWM
Puls width	10% ... 90%
Frequency	250 Hz

Electronics

Connection type	Male connector, M12, 4-pin
PIN assignment	1=n.c.; 2=V DC; 3=GND; 4=SIG
Electrical operation	
Supply voltage	9 V DC (7 ... 11 V DC)
Residual ripple	≤ ± 5 % S-S
Current consumption	≤ 50 mA
Overvoltage protection during power-up (60 s)	≤ 36 V at all poles during power-up (60 s)
Reverse polarity protection	≤ 16 (V DC - GND)
Insulation resistance	24 V DC (housing) R _{ISO} ≥ 10 MΩ, 60 s
Dielectric strength	0 V DC (60 s) to housing (R _{ISO} ≥ 1 MΩ)
Short-circuit protection	V _S – GND on housing

Mechanics

Dimensions	
Housing	48 mm, 48f7 for IN cylinder mounting – cylinder bore hole 48H8
∅ pressure pipe	10 mm
∅ O-ring	40.87 mm x 3.53 mm ¹⁾
∅ support ring	42.6 mm x 48 mm x 1.4 mm ²⁾
M12 flange	M12 flange type L: DM 24x24 mm - hole pattern 17 mm (EN 61076-2-101) ³⁾
Wire length	90 mm
Material	
Housing	Stainless steel 1.4305 (AISI 303)
Pressure pipe	Stainless steel 1.4306, AISI 304L
O-ring	NBR 75 ¹⁾
Support ring	PTFE
M12 male connector	Glass fiber reinforced polyamide, nickel-/gold-plated brass contacts
M12 flange	Nickel-plated brass with O-ring (NBR) ³⁾
Strands	TPE

¹⁾ Acc. to CAT[®] part number 118-8586.

²⁾ Acc. to CAT[®] part number 420-5767.

³⁾ Acc. to CAT[®] part number 435-3388 .

Ambient data

EMC	
Agricultural and forestry machinery	EN ISO 14982

¹⁾ R. H. 55%.

²⁾ With suitable coupling (sealing through O-ring in M12 coupling nut).

Transient pulses	ISO 7637-1/ISO 7637-2
ESD (air and contact discharge)	ISO 61000-4-2 / ISO 10605
Vibration	
Broadband noise (resonance peaks removed)	20.4 g (r.m.s.), 6 h / spatial axis, 20 ... 2,000 Hz (acc. to CAT [®] EC1 V9.0 Profile 10)
Pressure load	
Operating pressure P_N	35 MPa
Overload pressure $P_{max} = P_N \times 1.2$	42 MPa
Test pressure $P_{stat} = P_N \times 1.5$	53 MPa
Temperature and air humidity	
Storage	-20 °C ... +65 °C ¹⁾
Operation (electronics)	-40 °C ... +120 °C
Maximum air humidity	90 % (Condensation not permitted)
Enclosure rating	
Housing	According to CAT [®] "HOT DUNK TEST"
M12 male connector	IP69K (ISO 20653) ²⁾

¹⁾ R. H. 55%.

²⁾ With suitable coupling (sealing through O-ring in M12 coupling nut).

Classifications

ECLASS 5.0	27270705
ECLASS 5.1.4	27270705
ECLASS 6.0	27270705
ECLASS 6.2	27270705
ECLASS 7.0	27270705
ECLASS 8.0	27270705
ECLASS 8.1	27270705
ECLASS 9.0	27270705
ECLASS 10.0	27270705
ECLASS 11.0	27270705
ECLASS 12.0	27274304
ETIM 5.0	EC002544
ETIM 6.0	EC002544
ETIM 7.0	EC002544
ETIM 8.0	EC002544
UNSPSC 16.0901	41111613

Dimensional drawing M12 connector type L/ flange - radial seal

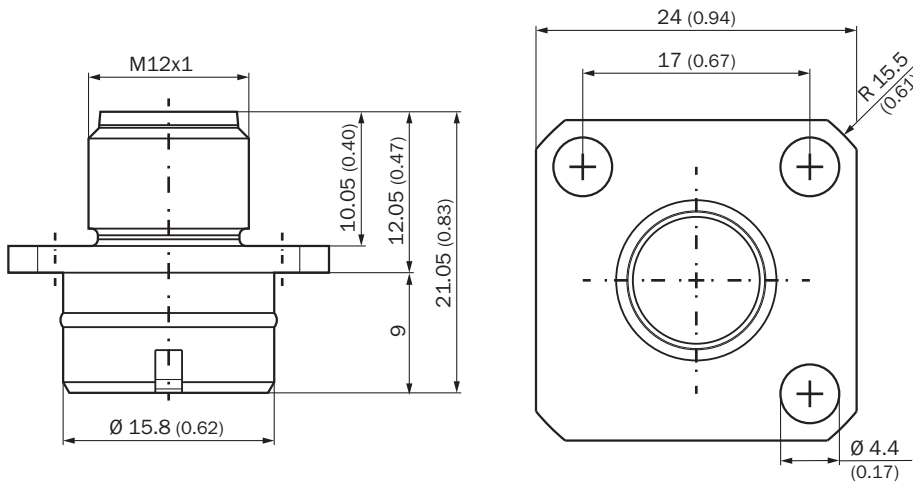

Dimensions in mm (inch)

Attachment specifications Installation space for cylinders

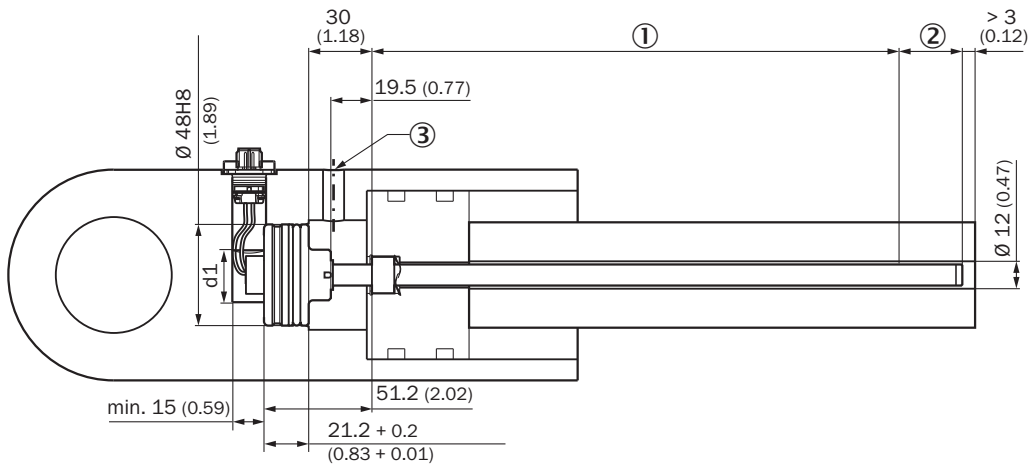

Please note the information in the operating instructions ($d: 32 \leq d1 \leq 40$).

- ① Measuring range
- ② damping zone
- ③ Hydraulic port

Pin assignment P (type L)



- ① N.C.
- ② V DC
- ③ GND
- ④ Signal

Connection diagram

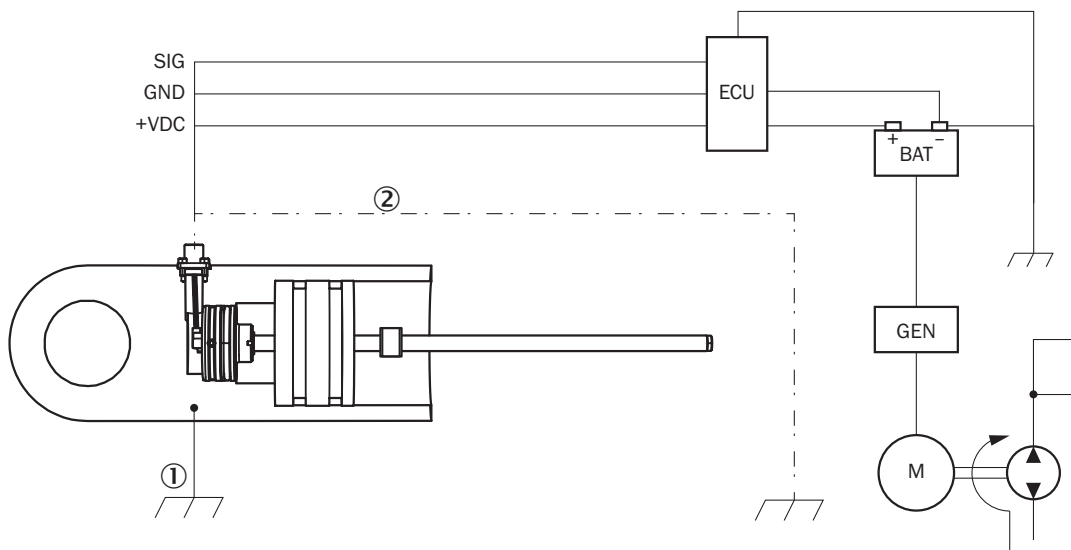

connection diagram

- ① Chassis GND
- ② Cable shielding (optional)

SICK AT A GLANCE

SICK is one of the leading manufacturers of intelligent sensors and sensor solutions for industrial applications. A unique range of products and services creates the perfect basis for controlling processes securely and efficiently, protecting individuals from accidents and preventing damage to the environment.

We have extensive experience in a wide range of industries and understand their processes and requirements. With intelligent sensors, we can deliver exactly what our customers need. In application centers in Europe, Asia and North America, system solutions are tested and optimized in accordance with customer specifications. All this makes us a reliable supplier and development partner.

Comprehensive services complete our offering: SICK LifeTime Services provide support throughout the machine life cycle and ensure safety and productivity.

For us, that is “Sensor Intelligence.”

WORLDWIDE PRESENCE:

Contacts and other locations –www.sick.com