



# KTS-WB9A64115AZZZ

KTS

CONTRAST SENSORS

**SICK**  
Sensor Intelligence.



Illustration may differ



### Ordering information

| Type               | part no. |
|--------------------|----------|
| KTS-WB9A64115AZZZZ | 1220794  |

Other models and accessories → [www.sick.com/KTS](http://www.sick.com/KTS)

### Detailed technical data

#### Features

|                                   |   |
|-----------------------------------|---|
| <b>Parameter presettings</b>      | None  |
| <b>Special applications</b>       | Standard  |
| <b>Device type</b>                | Standard  |
| <b>Housing design</b>             | Middle  |
| <b>Dimensions (W x H x D)</b>     | 26 mm x 62 mm x 47.5 mm   |
| <b>Light source</b>               | LED, RGB <sup>1)</sup>  |
| <b>Light emission</b>             | Long side of housing  |
| <b>Light spot size</b>            | Ø 10 mm   |
| <b>Light spot direction</b>       | Round   |
| <b>Receiving filters</b>          | None  |
| <b>Wave length</b>                | 470 nm, 525 nm, 625 nm  |
| <b>Sensing distance</b>           | ≤ 70 mm <sup>2)</sup>   |
| <b>Sensing distance tolerance</b> | ± 6 mm  |
| <b>Teach-in mode</b>              | 1-point teach-in, 2-point teach-in, teach-in dynamic, auto mode |
| <b>Output function</b>            | Light/dark switching  |
| <b>Delay time</b>                 | Adjustable  |
| <b>Special features</b>           | Long sensing distance   |
| <b>Setting the key lock</b>       | Standard  |

<sup>1)</sup> Average service life: 100,000 h at T<sub>U</sub> = +25 °C.

<sup>2)</sup> Sensing distance from leading edge of lens.

|                                  |                  |
|----------------------------------|------------------|
| <b>Delivery status</b>           | 2-point teach-in |
| <b>Safety-related parameters</b> |                  |
| MTTF <sub>D</sub>                | 291 years        |

<sup>1)</sup> Average service life: 100,000 h at T<sub>U</sub> = +25 °C.

<sup>2)</sup> Sensing distance from leading edge of lens.

## Interfaces

|                               |  |
|-------------------------------|--|
| <b>IO-Link</b>                | ✓, V1.1, IO-Link   |
| VendorID                      | 26   |
| DeviceID HEX                  | 8000A4   |
| DeviceID DEC                  | 8388772  |
| <b>Process data structure</b> | Bit 0 = switching signal Q <sub>L1</sub><br>Bit 1 = empty<br>Bit 2 = Quality of Run Alarm<br>Bit 3 ... 5 = Emission Color<br>Bit 6 ... 15 = Measurement Value Emission Color |
| <b>Digital output</b>         | Q <sub>1</sub> , Q <sub>2</sub>  |
| Number                        | 2  |
| <b>Digital input</b>          | In <sub>1</sub> , In <sub>2</sub>  |
| Number                        | 2  |

## Electronics

|                                       |  |
|---------------------------------------|--|
| <b>Supply voltage</b>                 | 10.8 V DC ... 28.8 V DC <sup>1)</sup>                      |
| <b>Ripple</b>                         | ≤ 5 V <sub>pp</sub> <sup>2)</sup>                          |
| <b>Current consumption</b>            | < 100 mA <sup>3)</sup>                                     |
| <b>Switching frequency</b>            | 50 kHz <sup>4)</sup> <sup>5)</sup>                         |
| <b>Response time</b>                  | 10 μs  |
| <b>Jitter</b>                         | 5 μs <sup>6)</sup>   |
| <b>Switching output</b>               | Push-pull: PNP/NPN   |
| <b>Switching output (voltage)</b>     | Push-pull: PNP/NPN HIGH = U <sub>V</sub> - 3 V / LOW ≤ 3 V |
| <b>Output current I<sub>max</sub></b> | 100 mA <sup>7)</sup>                                       |
| <b>Input, teach-in (ET)</b>           | Teach: U = 10 V ... < V <sub>S</sub>                       |
| <b>Input, blanking input (AT)</b>     | Blanked: U = 10 V ... < U <sub>v</sub>                     |
| <b>Input, fine/coarse (F/C)</b>       | Coarse: U = 10 V ... < U <sub>v</sub>                      |
| <b>Input, light/dark (L/D)</b>        | Light: U = 10 V ... < U <sub>v</sub>                       |
| <b>Retention time (ET)</b>            | 25 ms, non-volatile memory                                 |
| <b>Time delay</b>                     | None   |
| <b>Protection class</b>               | III  |

<sup>1)</sup> Limit values: DC 12 V (-10 %) ... DC 24 V (+20 %). Operation in short-circuit protected network max. 8 A.

<sup>2)</sup> May not fall below or exceed U<sub>v</sub> tolerances.

<sup>3)</sup> Without load.

<sup>4)</sup> With light/dark ratio 1:1.

<sup>5)</sup> 1-point teach-in (color mode): 16 kHz.

<sup>6)</sup> 1-point teach-in (color mode): 15 μs.

<sup>7)</sup> Total current of all Outputs.

|                           |  |
|---------------------------|--|
| <b>Circuit protection</b> | U <sub>V</sub> connections, reverse polarity protected<br>Output Q short-circuit protected<br>Interference pulse suppression |
| <b>Connection type</b>    | Plug, M12, 5-pin   |

- 1) Limit values: DC 12 V (-10 %) ... DC 24 V (+20 %). Operation in short-circuit protected network max. 8 A.
- 2) May not fall below or exceed U<sub>V</sub> tolerances.
- 3) Without load.
- 4) With light/dark ratio 1:1.
- 5) 1-point teach-in (color mode): 16 kHz.
- 6) 1-point teach-in (color mode): 15 μs.
- 7) Total current of all Outputs.

### Mechanics

|                         |         |
|-------------------------|---------|
| <b>Housing material</b> | VISTAL® |
| <b>Optics material</b>  | Glass   |
| <b>Weight</b>           | 68 g    |

### Ambient data

|                                      |  |
|--------------------------------------|--|
| <b>Ambient operating temperature</b> | -20 °C ... +60 °C                        |
| <b>Ambient temperature, storage</b>  | -25 °C ... +75 °C                        |
| <b>Shock load</b>                    | According to IEC 60068-2-27 (30 g/11 ms) |
| <b>Enclosure rating</b>              | IP67                                     |
| <b>UL File No.</b>                   | E181493                                  |

### Certificates

|  |   |
|--|---|
| <b>EU declaration of conformity</b>  | ✓ |
| <b>UK declaration of conformity</b>  | ✓ |
| <b>ACMA declaration of conformity</b>  | ✓ |
| <b>Moroccan declaration of conformity</b>                                    | ✓ |
| <b>China RoHS</b>  | ✓ |
| <b>cULus certificate</b>   | ✓ |
| <b>IO-Link certificate</b>   | ✓ |
| <b>Photobiological safety (IEC EN 62471)</b>                                 | ✓ |
| <b>Information according to Art. 3 of Data Act (Regulation EU 2023/2854)</b> | ✓ |

### Classifications

|                     |          |
|---------------------|----------|
| <b>ECLASS 5.0</b>   | 27270906 |
| <b>ECLASS 5.1.4</b> | 27270906 |
| <b>ECLASS 6.0</b>   | 27270906 |
| <b>ECLASS 6.2</b>   | 27270906 |
| <b>ECLASS 7.0</b>   | 27270906 |
| <b>ECLASS 8.0</b>   | 27270906 |
| <b>ECLASS 8.1</b>   | 27270906 |
| <b>ECLASS 9.0</b>   | 27270906 |
| <b>ECLASS 10.0</b>  | 27270906 |

|                       |          |
|-----------------------|----------|
| <b>ECLASS 11.0</b>    | 27270906 |
| <b>ECLASS 12.0</b>    | 27270906 |
| <b>ETIM 5.0</b>       | EC001820 |
| <b>ETIM 6.0</b>       | EC001820 |
| <b>ETIM 7.0</b>       | EC001820 |
| <b>ETIM 8.0</b>       | EC001820 |
| <b>UNSPSC 16.0901</b> | 39121528 |

Dimensional drawing Sensing distance from leading edge of lens

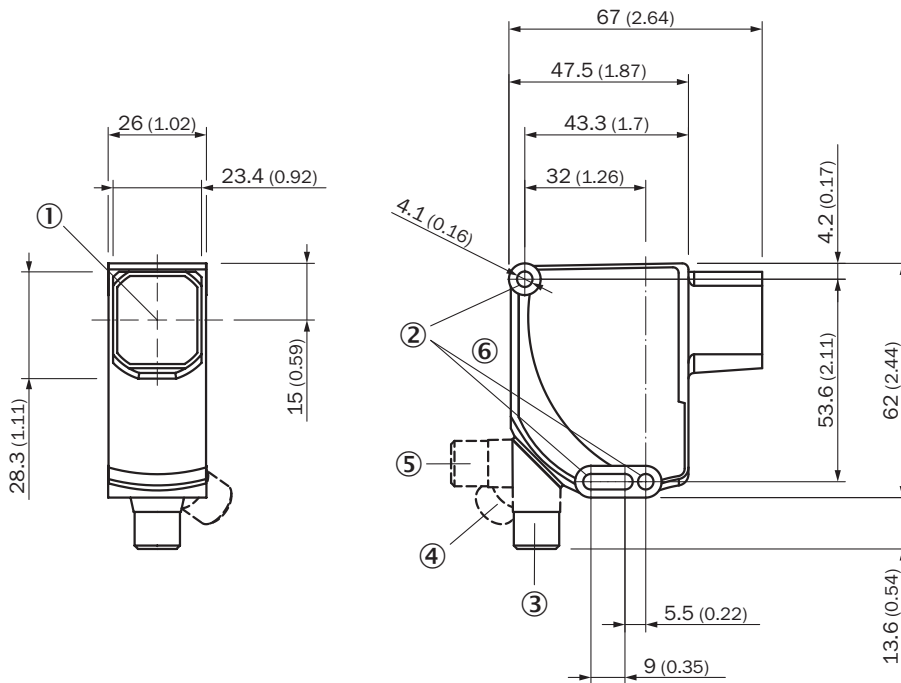

Dimensions in mm (inch)

- ① Optical axis
- ② fixing hole
- ③ M12 male connector, delivery state
- ④ M12 male connector, end stop right
- ⑤ M12 male connector, end stop left
- ⑥ display and adjustment elements

### display and adjustment elements

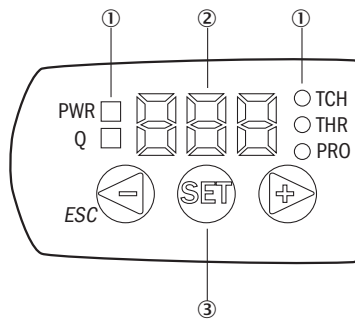

- ① LED status indicator
- ② Display
- ③ Navigation buttons

### Connection diagram Cd-387

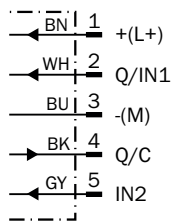

## KTS/KTX Prime - Setting the switching threshold (teach-in dynamic)

Suitable for teaching in moving objects.

### 1. Position background



Press the Set pushbutton to start the teach-in process.

### 2. Move at least the mark and background using the light spot



The display lights up during repeat length detection ( - - - ).



Press the Set pushbutton to end the teach-in process. The Quality of Teach is displayed.

### Example



### Switching characteristics

The optimum emitted light is selected automatically (at RGB variants).

Static teach-in: light/dark setting is defined using teach-in sequence.

Dynamic teach-in: switching output active on mark, if background is longer in the field of view during the teach-in. The switching threshold is set in the center between the background and the mark.

Keylock (activation and deactivation): Press and hold the “+” pushbutton > 10 s.

The Q-LED (yellow) flashes and the “Err” error message appears on the display.

### KTS/KTX Prime - setting the switching threshold (2-point teach-in)

Suitable for manual positioning of the object to be detected, e.g. marks and background.

#### 1. Position mark

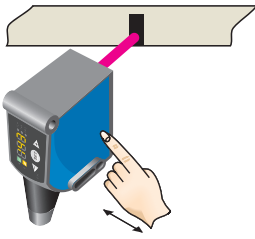

When setting the contrasts to be detected, "1st" flashes. Press set button.

#### 2. Position background

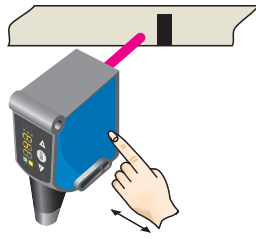



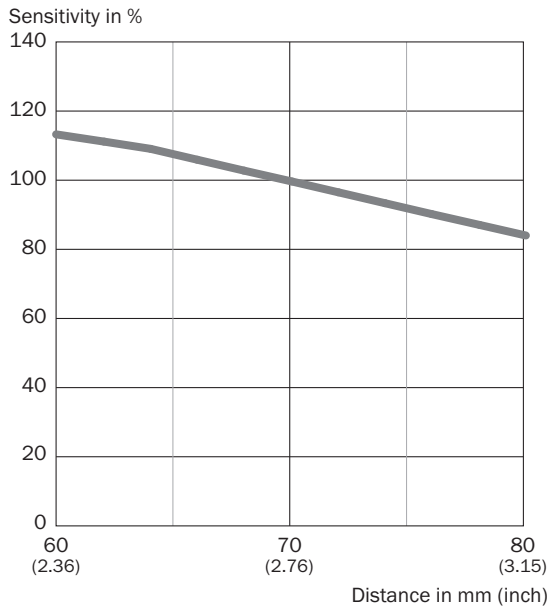

When setting the contrasts to be detected, "2nd" flashes. Press set button. The Quality of Teach is displayed.

### Sensing distance Sensing distance 70 mm



## Recommended accessories

Other models and accessories → [www.sick.com/KTS](http://www.sick.com/KTS)

|   | Brief description   | Type               | part no. |
|---|---|--------------------|----------|
| Mounting systems  |   |                    |          |
|    | <ul style="list-style-type: none"> <li><b>Description:</b> Plate K for universal clamp bracket</li> <li><b>Material:</b> Steel</li> <li><b>Details:</b> Steel, zinc coated</li> <li><b>Items supplied:</b> Universal clamp (2022726), mounting hardware</li> <li><b>Usable for:</b> W11-2, W12-3, W14-2, W18-3, W23-2, W24-2, W27-3, W30, W32, W34, W36, PL50A, PL80A, P250, UC12, LUT3, KT2, KT5-2, KT8, CS8, DT2, DS30, DS40, W12-2 Laser, W16, W26, KT5</li> </ul> | BEF-KHS-K01        | 2022718  |
| connectors and cables   |   |                    |          |
|    | <ul style="list-style-type: none"> <li><b>Description:</b> Unshielded</li> <li><b>Connection type head A:</b> Male connector, M12, 5-pin, straight, A-coded</li> <li><b>Connection systems:</b> Screw-type terminals</li> <li><b>Permitted cross-section:</b> ≤ 0.75 mm<sup>2</sup></li> <li><b>Note:</b> For field bus technology</li> </ul>   | STE-1205-G         | 6022083  |
|    | <ul style="list-style-type: none"> <li><b>Description:</b> Sensor/actuator cable, unshielded</li> <li><b>Connection type head A:</b> Female connector, M12, 5-pin, straight, A-coded</li> <li><b>Connection type head B:</b> Flying leads</li> <li><b>Signal type:</b> Sensor/actuator cable</li> <li><b>Cable:</b> 5 m, 5-wire, PVC</li> <li><b>Application:</b> Uncontaminated zones, Zones with chemicals</li> </ul>   | YF2A15-050VB5XLEAX | 2096240  |
| network devices   |   |                    |          |
|   |   | SIG200-0A0412200   | 1089794  |
|  |   | SIG200-0A0G12200   | 1102605  |

## SICK AT A GLANCE

SICK is one of the leading manufacturers of intelligent sensors and sensor solutions for industrial applications. A unique range of products and services creates the perfect basis for controlling processes securely and efficiently, protecting individuals from accidents and preventing damage to the environment.

We have extensive experience in a wide range of industries and understand their processes and requirements. With intelligent sensors, we can deliver exactly what our customers need. In application centers in Europe, Asia and North America, system solutions are tested and optimized in accordance with customer specifications. All this makes us a reliable supplier and development partner.

Comprehensive services complete our offering: SICK LifeTime Services provide support throughout the machine life cycle and ensure safety and productivity.

For us, that is “Sensor Intelligence.”

## WORLDWIDE PRESENCE:

Contacts and other locations –[www.sick.com](http://www.sick.com)