



# KTX-WBN114125AZZZZ

## KTX

CONTRAST SENSORS

**SICK**  
Sensor Intelligence.



Illustration may differ



### Ordering information

Type	part no.
KTX-WBN114125AZZZZ	1220056

Other models and accessories → [www.sick.com/KTX](http://www.sick.com/KTX)

### Detailed technical data

#### Features

<b>Parameter presettings</b>	None
<b>Special applications</b>	Color Sequence
<b>Device type</b>	Standard
<b>Housing design</b>	Large
<b>Dimensions (W x H x D)</b>	30 mm x 53 mm x 78.5 mm
<b>Light source</b>	LED, RGB <sup>1)</sup>
<b>Light emission</b>	Long side of housing
<b>Light spot size</b>	0.9 mm x 3.8 mm
<b>Light spot direction</b>	Vertical <sup>2)</sup>
<b>Receiving filters</b>	None
<b>Wave length</b>	470 nm, 525 nm, 625 nm
<b>Sensing distance</b>	≤ 13 mm
<b>Sensing distance tolerance</b>	± 5 mm
<b>Teach-in mode</b>	N-point teach-in, 2-point teach-in, teach-in dynamic, auto mode
<b>Output function</b>	Light/dark switching
<b>Delay time</b>	Adjustable
<b>Setting the key lock</b>	Standard
<b>Delivery status</b>	N-point-teach-in

<sup>1)</sup> Average service life: 100,000 h at T<sub>U</sub> = +25 °C.

<sup>2)</sup> In relation to long side of housing.

<b>Safety-related parameters</b>	
MTTF <sub>D</sub>	291 years

<sup>1)</sup> Average service life: 100,000 h at T<sub>U</sub> = +25 °C.

<sup>2)</sup> In relation to long side of housing.

## Interfaces

<b>IO-Link</b>	✓ , V1.1, IO-Link
VendorID	26
DeviceID HEX	8000A8
DeviceID DEC	8388776
<b>Process data structure</b>	Bit 0 = switching signal Q <sub>L1</sub> Bit 1 = empty Bit 2 = Quality of Run Alarm Bit 3 ... 5 = Emission Color Bit 6 ... 15 = Measurement Value Emission Color
<b>Digital output</b>	Q <sub>1</sub> , Q <sub>2</sub>
Number	2
<b>Digital input</b>	In <sub>1</sub> , In <sub>2</sub>
Number	2

## Electronics

<b>Supply voltage</b>	10.8 V DC ... 28.8 V DC <sup>1)</sup>
<b>Ripple</b>	≤ 5 V <sub>pp</sub> <sup>2)</sup>
<b>Current consumption</b>	< 100 mA <sup>3)</sup>
<b>Switching frequency</b>	11.5 kHz <sup>4)</sup> <sup>5)</sup>
<b>Response time</b>	42 μs
<b>Jitter</b>	21 μs <sup>6)</sup>
<b>Switching output</b>	Push-pull: PNP/NPN
<b>Switching output (voltage)</b>	Push-pull: PNP/NPN HIGH = U <sub>V</sub> - 3 V/LOW ≤ 3 V
<b>Output current I<sub>max.</sub></b>	100 mA <sup>7)</sup>
<b>Input, teach-in (ET)</b>	Teach: U = 10 V ... < U <sub>S</sub>
<b>Input, blanking input (AT)</b>	Blanked: U = 10 V ... < U <sub>v</sub>
<b>Input, fine/coarse (F/C)</b>	Coarse: U = 10 V ... < U <sub>v</sub>
<b>Input, light/dark (L/D)</b>	Light: U = 10 V ... < U <sub>v</sub>
<b>Retention time (ET)</b>	25 ms, non-volatile memory
<b>Time delay</b>	None
<b>Protection class</b>	III
<b>Circuit protection</b>	U <sub>V</sub> connections, reverse polarity protected

<sup>1)</sup> Limit values: DC 12 V (-10 %) ... DC 24 V (+20 %). Operation in short-circuit protected network max. 8 A.

<sup>2)</sup> May not fall below or exceed U<sub>V</sub> tolerances.

<sup>3)</sup> Without load.

<sup>4)</sup> With light/dark ratio 1:1.

<sup>5)</sup> Contrast mode: 35 kHz.

<sup>6)</sup> Contrast mode: 7 μs.

<sup>7)</sup> Total current of all Outputs.

<b>Connection type</b>	Output Q short-circuit protected Interference pulse suppression
	Plug, M12, 5-pin

- 1) Limit values: DC 12 V (-10 %) ... DC 24 V (+20 %). Operation in short-circuit protected network max. 8 A.
- 2) May not fall below or exceed  $U_V$  tolerances.
- 3) Without load.
- 4) With light/dark ratio 1:1.
- 5) Contrast mode: 35 kHz.
- 6) Contrast mode: 7  $\mu$ s.
- 7) Total current of all Outputs.

### Mechanics

<b>Housing material</b>	VISTAL®
<b>Optics material</b>	COP
<b>Weight</b>	94 g

### Ambient data

<b>Ambient operating temperature</b>	-20 °C ... +60 °C
<b>Ambient temperature, storage</b>	-25 °C ... +75 °C
<b>Shock load</b>	According to IEC 60068-2-27 (30 g/11 ms)
<b>Enclosure rating</b>	IP67
<b>UL File No.</b>	E181493

### Certificates

<b>EU declaration of conformity</b>	✓
<b>UK declaration of conformity</b>	✓
<b>ACMA declaration of conformity</b>	✓
<b>Moroccan declaration of conformity</b>	✓
<b>China RoHS</b>	✓
<b>cULus certificate</b>	✓
<b>IO-Link certificate</b>	✓
<b>Photobiological safety (IEC EN 62471)</b>	✓
<b>Information according to Art. 3 of Data Act (Regulation EU 2023/2854)</b>	✓

### Classifications

<b>ECLASS 5.0</b>	27270906
<b>ECLASS 5.1.4</b>	27270906
<b>ECLASS 6.0</b>	27270906
<b>ECLASS 6.2</b>	27270906
<b>ECLASS 7.0</b>	27270906
<b>ECLASS 8.0</b>	27270906
<b>ECLASS 8.1</b>	27270906
<b>ECLASS 9.0</b>	27270906
<b>ECLASS 10.0</b>	27270906
<b>ECLASS 11.0</b>	27270906

<b>ECLASS 12.0</b>	27270906
<b>ETIM 5.0</b>	EC001820
<b>ETIM 6.0</b>	EC001820
<b>ETIM 7.0</b>	EC001820
<b>ETIM 8.0</b>	EC001820
<b>UNSPSC 16.0901</b>	39121528

Dimensional drawing

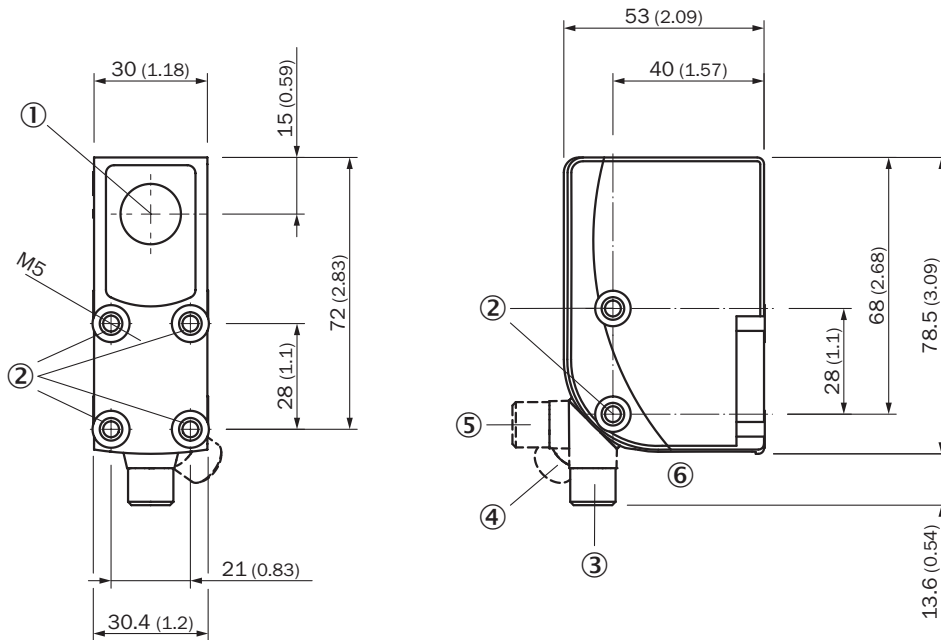

Dimensions in mm (inch)

- ① Optical axis
- ② Threaded mounting hole M5
- ③ M12 male connector, delivery state
- ④ M12 male connector, end stop right
- ⑤ M12 male connector, end stop left
- ⑥ display and adjustment elements

display and adjustment elements

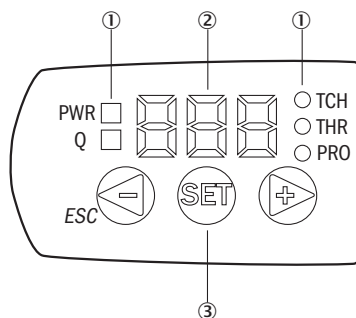

- ① LED status indicator

- ② Display
- ③ Navigation buttons

### Connection diagram Cd-387

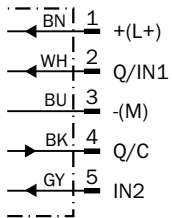

### Teaching-in of a sequence of up to eight contrast or color features

Suitable for teaching a sequence of up to eight contrast or color features.  
(here's an example of four contrast or color features)

**1. Position the first contrast or color feature under the light spot.**

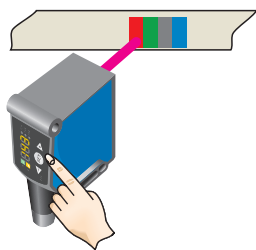

Confirm with the SET pushbutton.

**2. Position the second contrast or color feature under the light spot.**

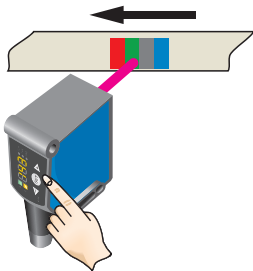

Confirm with the SET pushbutton.

**3. Position the third contrast or color feature under the light spot.**

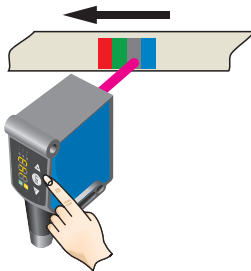

Confirm with the SET pushbutton.

**4. Position the last contrast or color feature to be detected under the light spot.**

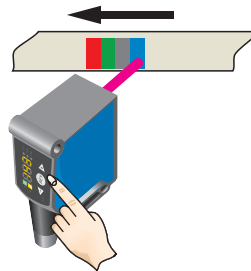

Confirm with the SET pushbutton.

### KTS/KTX Prime - Setting the switching threshold (color mode)

Suitable for teaching in color properties.

**1. Position mark/color property**

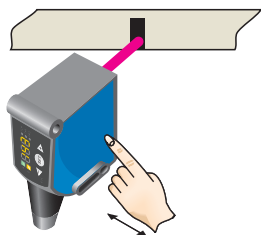



When detecting the contrast or color to be detected, "1st" flashes.  
Press set button. The Quality of Teach-in is displayed.

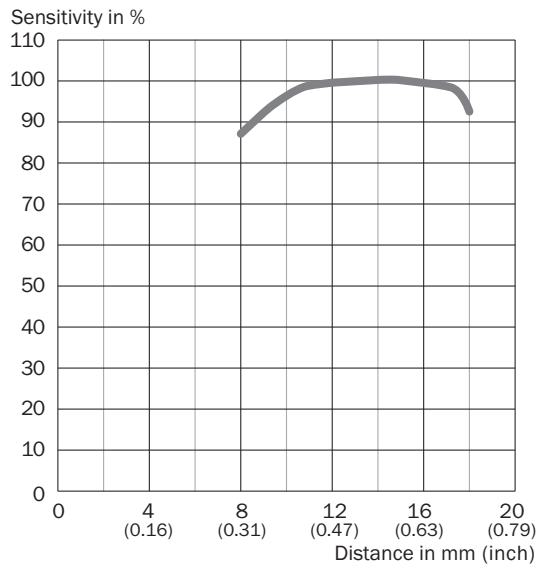

Sensing distance Sensing distance 13 mm, light spot direction horizontal/vertical



Recommended accessories

Other models and accessories → [www.sick.com/KTX](http://www.sick.com/KTX)

	Brief description	Type	part no.
<b>Mounting systems</b>			
	<ul style="list-style-type: none"> <li><b>Description:</b> Plate G for universal clamp bracket</li> <li><b>Material:</b> Steel</li> <li><b>Details:</b> Steel, zinc coated</li> <li><b>Items supplied:</b> Universal clamp (2022726), mounting hardware</li> <li><b>Usable for:</b> W34, LUT3, KT5-2, KT10, CS8, W24-2, KT8, KT8</li> </ul>	BEF-KHS-G01	2022464
<b>connectors and cables</b>			
	<ul style="list-style-type: none"> <li><b>Description:</b> Sensor/actuator cable, unshielded</li> <li><b>Connection type head A:</b> Female connector, M12, 5-pin, straight, A-coded</li> <li><b>Connection type head B:</b> Flying leads</li> <li><b>Signal type:</b> Sensor/actuator cable</li> <li><b>Cable:</b> 5 m, 5-wire, PVC</li> <li><b>Application:</b> Uncontaminated zones, Zones with chemicals</li> </ul>	YF2A15-050VB5XLEAX	2096240
	<ul style="list-style-type: none"> <li><b>Description:</b> Unshielded</li> <li><b>Connection type head A:</b> Male connector, M12, 5-pin, straight, A-coded</li> <li><b>Connection systems:</b> Screw-type terminals</li> <li><b>Permitted cross-section:</b> ≤ 0.75 mm<sup>2</sup></li> <li><b>Note:</b> For field bus technology</li> </ul>	STE-1205-G	6022083

	Brief description	Type	part no.
network devices			
		SIG200-0A0412200	1089794
		SIG200-0A0G12200	1102605

## SICK AT A GLANCE

SICK is one of the leading manufacturers of intelligent sensors and sensor solutions for industrial applications. A unique range of products and services creates the perfect basis for controlling processes securely and efficiently, protecting individuals from accidents and preventing damage to the environment.

We have extensive experience in a wide range of industries and understand their processes and requirements. With intelligent sensors, we can deliver exactly what our customers need. In application centers in Europe, Asia and North America, system solutions are tested and optimized in accordance with customer specifications. All this makes us a reliable supplier and development partner.

Comprehensive services complete our offering: SICK LifeTime Services provide support throughout the machine life cycle and ensure safety and productivity.

For us, that is “Sensor Intelligence.”

## WORLDWIDE PRESENCE:

Contacts and other locations –[www.sick.com](http://www.sick.com)