



# M40S-032202AU0

M4000 Standard

**SAFETY MULTIBEAM SENSORS**

**SICK**  
Sensor Intelligence.



### Ordering information

Type	part no.
M40S-032202AU0	1200084

Other models and accessories → [www.sick.com/M4000\\_Standard](http://www.sick.com/M4000_Standard)

Illustration may differ



### Detailed technical data

#### Features

<b>Specialty</b>	Actuator Sensor Interface replaces the system connection
<b>Functional principle</b>	Sender/receiver
<b>System part</b>	Sender
<b>Scanning range</b>	0.5 m ... 70 m, configurable
<b>Low scanning range</b>	0.5 m ... 20 m
<b>Great scanning range</b>	9 m ... 70 m
<b>Number of beams</b>	3
<b>Beam separation</b>	220 mm
<b>Synchronization</b>	Optical synchronization

#### Safety-related parameters

<b>Type</b>	Type 4 (IEC 61496-1)
<b>Safety integrity level</b>	SIL 3 (IEC 61508)
<b>Category</b>	Category 4 (EN ISO 13849)
<b>Performance level</b>	PL e (EN ISO 13849)
<b>PFH<sub>D</sub> (mean probability of a dangerous failure per hour)</b>	$6.6 \times 10^{-9}$ (EN ISO 13849)
<b>T<sub>M</sub> (mission time)</b>	20 years (EN ISO 13849)

#### Functions

	Functions	Delivery status
<b>Beam coding</b>	✓	Uncoded
<b>Configurable scanning range</b>	✓	

#### Interfaces

<b>Actuator Sensor Interface</b>	✓
----------------------------------	---

<b>System connection</b>	Male connector M12, 4-pin
<b>Configuration method</b>	Configuration buttons
<b>Display elements</b>	LEDs 7-segment display

## Electronics

<b>Protection class</b>	III (IEC 61140)
<b>Supply voltage <math>V_s</math></b>	(26 V DC ... 31.6 V DC)
<b>Power consumption</b>	$\leq 0.2$ A

## Mechanics

<b>Dimensions</b>	See dimensional drawing
<b>Housing cross-section</b>	52 mm x 55.5 mm
<b>Material</b>	
Housing	Aluminum alloy ALMGSI 0.5, powder coated
Front screen	Polycarbonate, scratch-resistant coating

## Ambient data

<b>Enclosure rating</b>	IP65 (EN 60529)
<b>Ambient operating temperature</b>	-30 °C ... +55 °C
<b>Storage temperature</b>	-30 °C ... +70 °C
<b>Air humidity</b>	15 % ... 95 %, Non-condensing
<b>Vibration resistance</b>	5 g, 10 Hz ... 55 Hz (EN 60068-2-6)
<b>Shock resistance</b>	10 g, 16 ms (EN 60068-2-27)

## Other information

<b>Wave length</b>	850 nm
--------------------	--------

## Certificates

<b>EU declaration of conformity</b>	✓
<b>UK declaration of conformity</b>	✓
<b>ACMA declaration of conformity</b>	✓
<b>Moroccan declaration of conformity</b>	✓
<b>China RoHS</b>	✓
<b>cTUVus certificate</b>	✓
<b>EC-Type-Examination approval</b>	✓
<b>Information according to Art. 3 of Data Act (Regulation EU 2023/2854)</b>	✓

## Classifications

<b>ECLASS 5.0</b>	27272703
<b>ECLASS 5.1.4</b>	27272703
<b>ECLASS 6.0</b>	27272703
<b>ECLASS 6.2</b>	27272703
<b>ECLASS 7.0</b>	27272703
<b>ECLASS 8.0</b>	27272703
<b>ECLASS 8.1</b>	27272703

<b>ECLASS 9.0</b>	27272703
<b>ECLASS 10.0</b>	27272703
<b>ECLASS 11.0</b>	27272703
<b>ECLASS 12.0</b>	27272703
<b>ETIM 5.0</b>	EC001832
<b>ETIM 6.0</b>	EC001832
<b>ETIM 7.0</b>	EC001832
<b>ETIM 8.0</b>	EC001832
<b>UNSPSC 16.0901</b>	46171620

Dimensional drawing

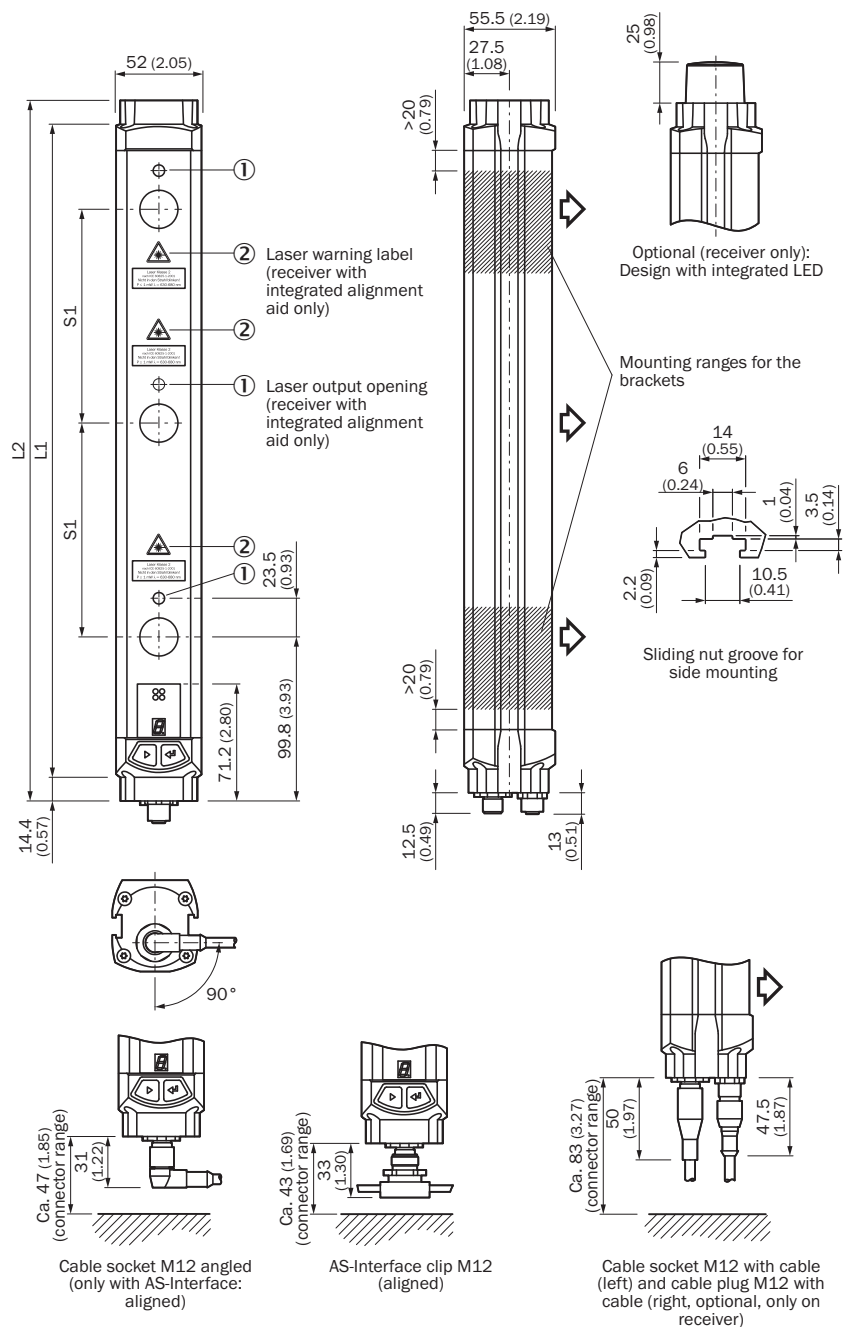





Dimensions in mm (inch)  
illustration sender (receiver mirror image)

Number of beams	Beam separation S1	L1	L2
2	500 (19.69)	643 (25.31)	672 (26.46)
	600 (23.62)	743 (29.25)	772 (30.39)
3	220 (8.66)	583 (22.95)	612 (24.09)
	400 (15.75)	943 (37.13)	972 (38.27)
	450 (17.72)	1,043 (41.06)	1,072 (42.20)
4	220 (8.66)	803 (31.61)	832 (32.76)

Number of beams	Beam separation S1	L1	L2
5	300 (11.81)	1,043 (41.06)	1,072 (42.20)
	220 (8.66)	1,023 (40.28)	1,052 (41.42)
6	220 (8.66)	1,243 (48.94)	1,272 (50.08)
7		1,462 (57.56)	1,491 (58.70)
8		1,682 (66.22)	1,711 (67.36)

### Recommended accessories

Other models and accessories → [www.sick.com/M4000\\_Standard](http://www.sick.com/M4000_Standard)

	Brief description	Type	part no.
<b>Mounting systems</b>			
	<ul style="list-style-type: none"> <li><b>Description:</b> Mounting kit 6, side bracket, rotatable</li> <li><b>Material:</b> Zinc diecast</li> <li><b>Details:</b> Zinc diecast</li> <li><b>Packing unit:</b> 4 pieces</li> <li><b>Suitable for:</b> All protective field heights</li> </ul>	BEF-1SHABAZN4	2019506
	<ul style="list-style-type: none"> <li><b>Description:</b> Mounting kit 1, mounting bracket, rigid, L-shaped, including fixing screws and washers</li> <li><b>Packing unit:</b> 4 pieces</li> <li><b>Suitable for:</b> All protective field heights</li> </ul>	BEF-3WNGBAST4	7021352
	<ul style="list-style-type: none"> <li><b>Description:</b> Mounting kit 12, rotatable, swivel mount</li> <li><b>Packing unit:</b> 4 pieces</li> <li><b>Suitable for:</b> All protective field heights</li> </ul>	BEF-2SMGEAKU4	2030510
<b>Commissioning aids and test equipment</b>			
	<ul style="list-style-type: none"> <li><b>Product:</b> Alignment aids</li> <li><b>Dimensions (W x H x L):</b> 19 mm 67.3 mm 66.9 mm</li> <li><b>Description:</b> Laser alignment aid for various sensors, laser class 2 (IEC 60825). Do not look into the beam!</li> </ul>	AR60	1015741
	<ul style="list-style-type: none"> <li><b>Product:</b> Alignment aids</li> <li><b>Description:</b> Adapter AR60 for M4000 and M4000 Curtain</li> </ul>	AR60 adapter, M4000	4040006

## SICK AT A GLANCE

SICK is one of the leading manufacturers of intelligent sensors and sensor solutions for industrial applications. A unique range of products and services creates the perfect basis for controlling processes securely and efficiently, protecting individuals from accidents and preventing damage to the environment.

We have extensive experience in a wide range of industries and understand their processes and requirements. With intelligent sensors, we can deliver exactly what our customers need. In application centers in Europe, Asia and North America, system solutions are tested and optimized in accordance with customer specifications. All this makes us a reliable supplier and development partner.

Comprehensive services complete our offering: SICK LifeTime Services provide support throughout the machine life cycle and ensure safety and productivity.

For us, that is “Sensor Intelligence.”

## WORLDWIDE PRESENCE:

Contacts and other locations –[www.sick.com](http://www.sick.com)