

# SICK

## BTF13-N1BM1077

HighLine

WIRE DRAW ENCODERS

**SICK**  
Sensor Intelligence.



### Ordering information

Type	part no.
BTF13-N1BM1077	1150703

**Included in delivery:** ANM58B-SANNB0000101000XX018X16 (1), MRA-F130-110D2 (1)

Other models and accessories → [www.sick.com/HighLine](http://www.sick.com/HighLine)



### Detailed technical data

#### Safety-related parameters

<b>MTTF<sub>D</sub> (mean time to dangerous failure)</b>	165 years (EN ISO 13849-1) <sup>1)</sup>
--	--

<sup>1)</sup> This product is a standard product and does not constitute a safety component as defined in the Machinery Directive. Calculation based on nominal load of components, average ambient temperature 40 °C, frequency of use 8760 h/a. All electronic failures are considered hazardous. For more information, see document no. 8015532.

#### Performance

<b>Measurement range</b>	0 m ... 10 m
<b>Encoder</b>	Absolute encoders
<b>Resolution (wire draw + encoder)</b>	0.0013 mm <sup>1) 2)</sup>
<b>Repeatability</b>	≤ 1.5 mm <sup>3)</sup>
<b>Linearity</b>	≤ ± 2 mm <sup>3)</sup>
<b>Hysteresis</b>	≤ 3 mm <sup>3)</sup>

<sup>1)</sup> The values shown have been rounded.

<sup>2)</sup> Example calculation based on the BTF08 with PROFINET: 200 mm (wire draw length per revolution - see Mechanical data): 262,144 (number of steps per revolution) = 0.001 mm (resolution of wire draw + encoder combination).

<sup>3)</sup> Value applies to wire draw mechanism.

#### Interfaces

<b>Communication interface</b>	PROFINET
<b>Programmable/configurable</b>	✓

#### Electronics

<b>Connection type</b>	Male connector, 1x, M12, 4-pin, axial Female connector, 2x, M12, 4-pin, axial
<b>Supply voltage</b>	10 V ... 32 V
<b>Power consumption</b>	≤ 3 W (without load)

#### Mechanics

<b>Weight</b>	Approx. 4 kg
---------------	--------------

<sup>1)</sup> These values were measured at an ambient temperature of 25 °C. There may be variations at other temperatures.

<sup>2)</sup> Average values, which depend on the application.

<sup>3)</sup> The service life depends on the type of load. This is influenced by environmental conditions, the installation location, the measuring range in use, the traversing speed, and acceleration.

<b>Measuring wire material</b>	Highly flexible stranded steel 1,4401 stainless steel V4A
<b>Measuring wire diameter</b>	1.35 mm
<b>Weight (measuring wire)</b>	7.1 g/m
<b>Housing material, wire draw mechanism</b>	Aluminum (anodised), plastic
<b>Spring return force</b>	10 N ... 20 N <sup>1)</sup>
<b>Length of wire pulled out per revolution</b>	332.4 mm
<b>Life of wire draw mechanism</b>	Typ. 1,000,000 cycles <sup>2) 3)</sup>
<b>Actual wire draw length</b>	10.2 m
<b>Wire acceleration</b>	40 m/s <sup>2</sup>
<b>Operating speed</b>	8 m/s
<b>Mounted encoder</b>	ANM58 PROFINET, ANM58B-SANNB0000101000XX018X16, 1145910
<b>Mounted mechanic</b>	MRA-F130-110D2, 6028627

<sup>1)</sup> These values were measured at an ambient temperature of 25 °C. There may be variations at other temperatures.

<sup>2)</sup> Average values, which depend on the application.

<sup>3)</sup> The service life depends on the type of load. This is influenced by environmental conditions, the installation location, the measuring range in use, the traversing speed, and acceleration.

### Ambient data

<b>EMC</b>	According to EN 61000-6-2 and EN 61000-6-3 <sup>1)</sup>
<b>Enclosure rating</b>	IP64, mounted mechanic IP65, Encoder (IEC 60529)
<b>Operating temperature range</b>	-30 °C ... +70 °C

<sup>1)</sup> The EMC according to the standards quoted is achieved if screened cables are used.

### Classifications

<b>ECLASS 5.0</b>	27270590
<b>ECLASS 5.1.4</b>	27270590
<b>ECLASS 6.0</b>	27270590
<b>ECLASS 6.2</b>	27270590
<b>ECLASS 7.0</b>	27270590
<b>ECLASS 8.0</b>	27270590
<b>ECLASS 8.1</b>	27270590
<b>ECLASS 9.0</b>	27270590
<b>ECLASS 10.0</b>	27270613
<b>ECLASS 11.0</b>	27270503
<b>ECLASS 12.0</b>	27270503
<b>ETIM 5.0</b>	EC001486
<b>ETIM 6.0</b>	EC001486
<b>ETIM 7.0</b>	EC001486
<b>ETIM 8.0</b>	EC001486
<b>UNSPSC 16.0901</b>	41112113

### Certificates

<b>EU declaration of conformity</b>	✓
-------------------------------------	---

<b>UK declaration of conformity</b>	✓
<b>ACMA declaration of conformity</b>	✓
<b>Moroccan declaration of conformity</b>	✓
<b>China RoHS</b>	✓

### Dimensional drawing

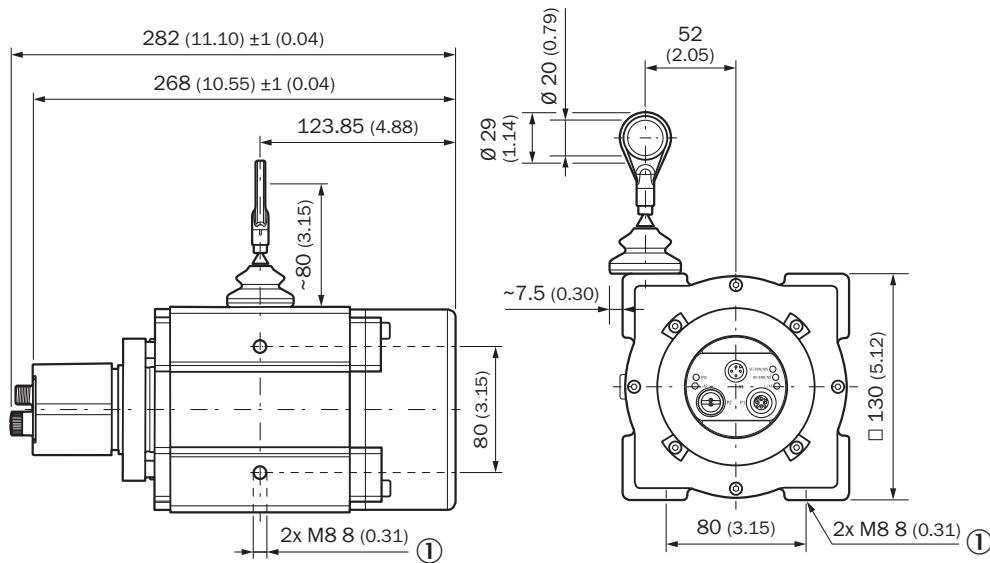

Dimensions in mm (inch)

Anschlussbelegung Female connector

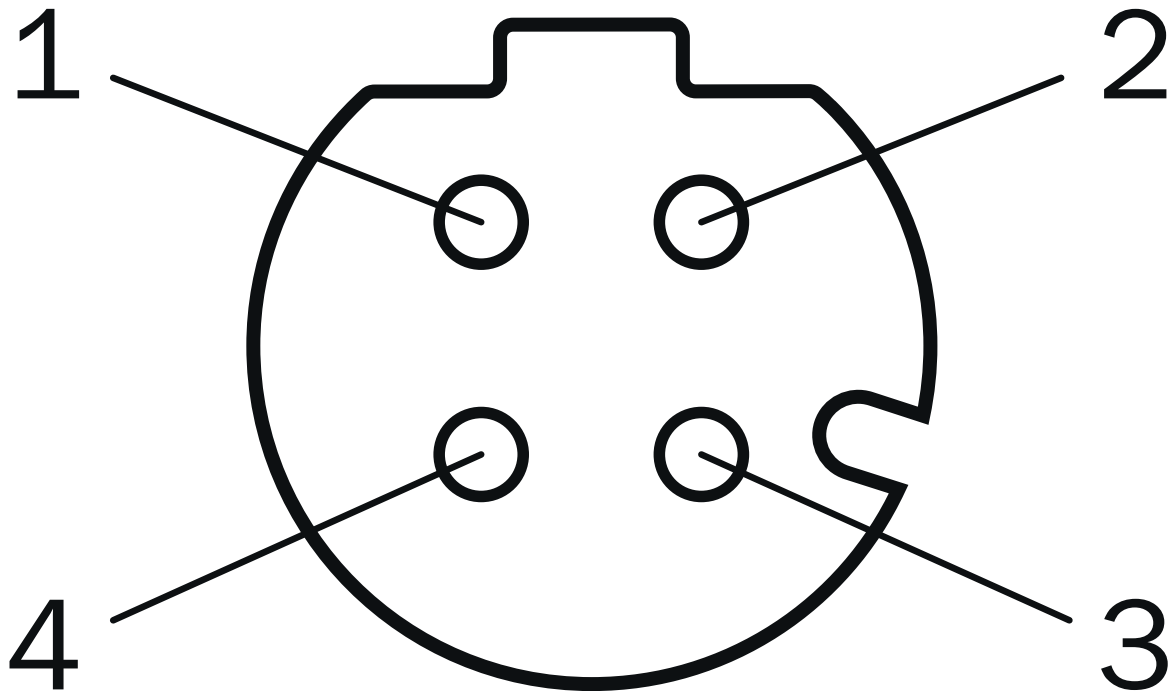

Port 1, Port 2

PIN	Wire color	Signal
1	Yellow	T x D+
2	White	R x D+
3	Orange	T x D-
4	Blue	R x D-

### Anschlussbelegung Male connector

















### Supply voltage

PIN	Wire color	Signal
1	Brown	U <sub>S</sub> 10 V ... 30 V
2	White	Not assigned
3	Blue	GND
4	Black	Not assigned

**Recommended accessories**



Other models and accessories → [www.sick.com/HighLine](http://www.sick.com/HighLine)

	<b>Brief description</b>	<b>Type</b>	<b>part no.</b>
<b>Mounting systems</b>			
	<ul style="list-style-type: none"> <li><b>Description:</b> Joint ball for later insertion in wire end ring with 20 mm diameter. The use of this joint ball enables movement in multiple levels of freedom.</li> </ul>	Joint protection for wire rope BTF/PRF/MRA	5318683
	<ul style="list-style-type: none"> <li><b>Description:</b> Compressed air attachment for MRA-F080... and MRA-F130... HighLine wire draw mechanism</li> </ul>	MRA-F-P	6073769
	<ul style="list-style-type: none"> <li><b>Description:</b> Flange adapter for HighLine wire draw mechanisms, adaption of face mount flange with centering hub 20 mm to 50 mm servo flange</li> <li><b>Material:</b> Aluminum</li> <li><b>Details:</b> Aluminum</li> <li><b>Items supplied:</b> Including 3 countersunk screws M3 x 10</li> </ul>	BEF-FA-020-050WDE	2073776

	Brief description	Type	part no.
connectors and cables			
	<ul style="list-style-type: none"> <li>• <b>Connection type head A:</b> Male connector, RJ45, 4-pin, straight</li> <li>• <b>Connection type head B:</b> Male connector, M12, 4-pin, angled, D-coded</li> <li>• <b>Signal type:</b> Ethernet, PROFINET</li> <li>• <b>Cable:</b> 30 m, 4-wire, CAT5, CAT5e, PVC</li> <li>• <b>Description:</b> Ethernet, shielded, PROFINET</li> </ul>	SSL-2J04-F30MZ	6059450
	<ul style="list-style-type: none"> <li>• <b>Description:</b> PROFINET, shielded</li> <li>• <b>Connection type head A:</b> Male connector, M12, 4-pin, angled, D-coded</li> <li>• <b>Signal type:</b> PROFINET</li> <li>• <b>Cable:</b> CAT5, CAT5e</li> <li>• <b>Connection systems:</b> IDC quick connection</li> <li>• <b>Permitted cross-section:</b> 0.14 mm<sup>2</sup> ... 0.34 mm<sup>2</sup></li> </ul>	STE-1204-WZ	6048262
	<ul style="list-style-type: none"> <li>• <b>Description:</b> Sensor/actuator cable, unshielded</li> <li>• <b>Connection type head A:</b> Female connector, M12, 4-pin, straight, A-coded</li> <li>• <b>Connection type head B:</b> Flying leads</li> <li>• <b>Signal type:</b> Sensor/actuator cable</li> <li>• <b>Cable:</b> 1 m, 4-wire, PUR, halogen-free</li> <li>• <b>Application:</b> Drag chain operation, Zones with oils and lubricants, Robot, Drag chain operation</li> </ul>	YF2A14-010UB3XLEAX	2145655
	<ul style="list-style-type: none"> <li>• <b>Description:</b> Sensor/actuator cable, unshielded</li> <li>• <b>Connection type head A:</b> Female connector, M12, 4-pin, straight, A-coded</li> <li>• <b>Connection type head B:</b> Flying leads</li> <li>• <b>Signal type:</b> Sensor/actuator cable</li> <li>• <b>Cable:</b> 2 m, 4-wire, PUR, halogen-free</li> <li>• <b>Application:</b> Drag chain operation, Zones with oils and lubricants, Robot, Drag chain operation</li> </ul>	YF2A14-020UB3XLEAX	2095607
	<ul style="list-style-type: none"> <li>• <b>Description:</b> Sensor/actuator cable, unshielded</li> <li>• <b>Connection type head A:</b> Female connector, M12, 4-pin, straight, A-coded</li> <li>• <b>Connection type head B:</b> Flying leads</li> <li>• <b>Signal type:</b> Sensor/actuator cable</li> <li>• <b>Cable:</b> 3 m, 4-wire, PUR, halogen-free</li> <li>• <b>Application:</b> Drag chain operation, Zones with oils and lubricants, Robot, Drag chain operation</li> </ul>	YF2A14-030UB3XLEAX	2145656
	<ul style="list-style-type: none"> <li>• <b>Description:</b> Sensor/actuator cable, unshielded</li> <li>• <b>Connection type head A:</b> Female connector, M12, 4-pin, straight, A-coded</li> <li>• <b>Connection type head B:</b> Flying leads</li> <li>• <b>Signal type:</b> Sensor/actuator cable</li> <li>• <b>Cable:</b> 5 m, 4-wire, PUR, halogen-free</li> <li>• <b>Application:</b> Drag chain operation, Zones with oils and lubricants, Robot, Drag chain operation</li> </ul>	YF2A14-050UB3XLEAX	2095608
	<ul style="list-style-type: none"> <li>• <b>Description:</b> Sensor/actuator cable, unshielded</li> <li>• <b>Connection type head A:</b> Female connector, M12, 4-pin, straight, A-coded</li> <li>• <b>Connection type head B:</b> Flying leads</li> <li>• <b>Signal type:</b> Sensor/actuator cable</li> <li>• <b>Cable:</b> 10 m, 4-wire, PUR, halogen-free</li> <li>• <b>Application:</b> Drag chain operation, Zones with oils and lubricants, Robot, Drag chain operation</li> </ul>	YF2A14-100UB3XLEAX	2095609
	<ul style="list-style-type: none"> <li>• <b>Description:</b> Sensor/actuator cable, unshielded</li> <li>• <b>Connection type head A:</b> Female connector, M12, 4-pin, straight, A-coded</li> <li>• <b>Connection type head B:</b> Flying leads</li> <li>• <b>Signal type:</b> Sensor/actuator cable</li> <li>• <b>Cable:</b> 20 m, 4-wire, PUR, halogen-free</li> <li>• <b>Application:</b> Drag chain operation, Zones with oils and lubricants, Robot, Drag chain operation</li> </ul>	YF2A14-200UB3XLEAX	2095611
	<ul style="list-style-type: none"> <li>• <b>Description:</b> Sensor/actuator cable, unshielded</li> <li>• <b>Connection type head A:</b> Female connector, M12, 4-pin, straight, A-coded</li> <li>• <b>Connection type head B:</b> Flying leads</li> <li>• <b>Signal type:</b> Sensor/actuator cable</li> <li>• <b>Cable:</b> 25 m, 4-wire, PUR, halogen-free</li> <li>• <b>Application:</b> Drag chain operation, Zones with oils and lubricants, Robot, Drag chain operation</li> </ul>	YF2A14-250UB3XLEAX	2095615
	<ul style="list-style-type: none"> <li>• <b>Description:</b> Sensor/actuator cable, unshielded</li> <li>• <b>Connection type head A:</b> Female connector, M12, 4-pin, straight, A-coded</li> <li>• <b>Connection type head B:</b> Flying leads</li> <li>• <b>Signal type:</b> Sensor/actuator cable</li> <li>• <b>Cable:</b> 0.6 m, 4-wire, PUR, halogen-free</li> <li>• <b>Application:</b> Drag chain operation, Zones with oils and lubricants, Robot, Drag chain operation</li> </ul>	YF2A14-C60UB3XLEAX	2145654
	<ul style="list-style-type: none"> <li>• <b>Description:</b> Sensor/actuator cable, unshielded</li> <li>• <b>Connection type head A:</b> Female connector, M12, 4-pin, angled, A-coded</li> <li>• <b>Connection type head B:</b> Flying leads</li> <li>• <b>Signal type:</b> Sensor/actuator cable</li> <li>• <b>Cable:</b> 1 m, 4-wire, PUR, halogen-free</li> </ul>	YG2A14-010UB3XLEAX	2145658

	Brief description	Type	part no.
	<ul style="list-style-type: none"> <li><b>Application:</b> Drag chain operation, Zones with oils and lubricants, Robot, Drag chain operation</li> <li><b>Description:</b> Sensor/actuator cable, unshielded</li> <li><b>Connection type head A:</b> Female connector, M12, 4-pin, angled, A-coded</li> <li><b>Connection type head B:</b> Flying leads</li> <li><b>Signal type:</b> Sensor/actuator cable</li> <li><b>Cable:</b> 2 m, 4-wire, PUR, halogen-free</li> <li><b>Application:</b> Drag chain operation, Zones with oils and lubricants, Robot, Drag chain operation</li> </ul>	YG2A14-020UB3XLEAX	2095766
	<ul style="list-style-type: none"> <li><b>Description:</b> Sensor/actuator cable, unshielded</li> <li><b>Connection type head A:</b> Female connector, M12, 4-pin, angled, A-coded</li> <li><b>Connection type head B:</b> Flying leads</li> <li><b>Signal type:</b> Sensor/actuator cable</li> <li><b>Cable:</b> 5 m, 4-wire, PUR, halogen-free</li> <li><b>Application:</b> Drag chain operation, Zones with oils and lubricants, Robot, Drag chain operation</li> </ul>	YG2A14-050UB3XLEAX	2095767
	<ul style="list-style-type: none"> <li><b>Description:</b> Sensor/actuator cable, unshielded</li> <li><b>Connection type head A:</b> Female connector, M12, 4-pin, angled, A-coded</li> <li><b>Connection type head B:</b> Flying leads</li> <li><b>Signal type:</b> Sensor/actuator cable</li> <li><b>Cable:</b> 10 m, 4-wire, PUR, halogen-free</li> <li><b>Application:</b> Drag chain operation, Zones with oils and lubricants, Robot, Drag chain operation</li> </ul>	YG2A14-100UB3XLEAX	2095768
	<ul style="list-style-type: none"> <li><b>Description:</b> Sensor/actuator cable, unshielded</li> <li><b>Connection type head A:</b> Female connector, M12, 4-pin, angled, A-coded</li> <li><b>Connection type head B:</b> Flying leads</li> <li><b>Signal type:</b> Sensor/actuator cable</li> <li><b>Cable:</b> 20 m, 4-wire, PUR, halogen-free</li> <li><b>Application:</b> Drag chain operation, Zones with oils and lubricants, Robot, Drag chain operation</li> </ul>	YG2A14-200UB3XLEAX	2095770
	<ul style="list-style-type: none"> <li><b>Description:</b> Sensor/actuator cable, unshielded</li> <li><b>Connection type head A:</b> Female connector, M12, 4-pin, angled, A-coded</li> <li><b>Connection type head B:</b> Flying leads</li> <li><b>Signal type:</b> Sensor/actuator cable</li> <li><b>Cable:</b> 25 m, 4-wire, PUR, halogen-free</li> <li><b>Application:</b> Drag chain operation, Zones with oils and lubricants, Robot, Drag chain operation</li> </ul>	YG2A14-250UB3XLEAX	2095771
	<ul style="list-style-type: none"> <li><b>Connection type head A:</b> Male connector, M12, 4-pin, straight, D-coded</li> <li><b>Connection type head B:</b> Male connector, RJ45, 4-pin, straight</li> <li><b>Signal type:</b> Ethernet, PROFINET</li> <li><b>Cable:</b> 2 m, 4-wire, PUR, halogen-free</li> <li><b>Description:</b> Ethernet, shielded, PROFINET</li> <li><b>Application:</b> Drag chain operation, Zones with oils and lubricants</li> </ul>	YM2D24-020P-N1MRJA4	2106182
	<ul style="list-style-type: none"> <li><b>Connection type head A:</b> Male connector, M12, 4-pin, straight, D-coded</li> <li><b>Connection type head B:</b> Flying leads</li> <li><b>Signal type:</b> Ethernet, PROFINET</li> <li><b>Cable:</b> 2 m, 4-wire, PUR, halogen-free</li> <li><b>Description:</b> Ethernet, shielded, PROFINET</li> <li><b>Application:</b> Drag chain operation, Zones with oils and lubricants</li> </ul>	YM2D24-020P-N1XLEAX	2106171
	<ul style="list-style-type: none"> <li><b>Connection type head A:</b> Male connector, M12, 4-pin, straight, D-coded</li> <li><b>Connection type head B:</b> Male connector, RJ45, 4-pin, straight</li> <li><b>Signal type:</b> Ethernet, PROFINET</li> <li><b>Cable:</b> 5 m, 4-wire, PUR, halogen-free</li> <li><b>Description:</b> Ethernet, shielded, PROFINET</li> <li><b>Application:</b> Drag chain operation, Zones with oils and lubricants</li> </ul>	YM2D24-050P-N1MRJA4	2106184
	<ul style="list-style-type: none"> <li><b>Connection type head A:</b> Male connector, M12, 4-pin, straight, D-coded</li> <li><b>Connection type head B:</b> Flying leads</li> <li><b>Signal type:</b> Ethernet, PROFINET</li> <li><b>Cable:</b> 5 m, 4-wire, PUR, halogen-free</li> <li><b>Description:</b> Ethernet, shielded, PROFINET</li> <li><b>Application:</b> Drag chain operation, Zones with oils and lubricants</li> </ul>	YM2D24-050P-N1XLEAX	2106172
	<ul style="list-style-type: none"> <li><b>Connection type head A:</b> Male connector, M12, 4-pin, straight, D-coded</li> <li><b>Connection type head B:</b> Male connector, RJ45, 4-pin, straight</li> <li><b>Signal type:</b> Ethernet, PROFINET</li> <li><b>Cable:</b> 10 m, 4-wire, PUR, halogen-free</li> <li><b>Description:</b> Ethernet, shielded, PROFINET</li> <li><b>Application:</b> Drag chain operation, Zones with oils and lubricants</li> </ul>	YM2D24-100P-N1MRJA4	2106185
	<ul style="list-style-type: none"> <li><b>Connection type head A:</b> Male connector, M12, 4-pin, straight, D-coded</li> <li><b>Connection type head B:</b> Flying leads</li> <li><b>Signal type:</b> Ethernet, PROFINET</li> <li><b>Cable:</b> 10 m, 4-wire, PUR, halogen-free</li> <li><b>Description:</b> Ethernet, shielded, PROFINET</li> </ul>	YM2D24-100P-N1XLEAX	2106173

	Brief description	Type	part no.
	<ul style="list-style-type: none"> <li>• <b>Application:</b> Drag chain operation, Zones with oils and lubricants</li> <li>• <b>Connection type head A:</b> Male connector, M12, 4-pin, angled, D-coded</li> <li>• <b>Connection type head B:</b> Male connector, RJ45, 4-pin, straight</li> <li>• <b>Signal type:</b> Ethernet, PROFINET</li> <li>• <b>Cable:</b> 2 m, 4-wire, PUR, halogen-free</li> <li>• <b>Description:</b> Ethernet, shielded, PROFINET</li> <li>• <b>Application:</b> Drag chain operation, Zones with oils and lubricants</li> </ul>	YN2D24-020P-N1MRJA4	2106162
	<ul style="list-style-type: none"> <li>• <b>Connection type head A:</b> Male connector, M12, 4-pin, angled, D-coded</li> <li>• <b>Connection type head B:</b> Male connector, M12, 4-pin, angled, D-coded</li> <li>• <b>Signal type:</b> Ethernet, PROFINET</li> <li>• <b>Cable:</b> 2 m, 4-wire, PUR, halogen-free</li> <li>• <b>Description:</b> Ethernet, shielded, PROFINET</li> <li>• <b>Application:</b> Drag chain operation, Zones with oils and lubricants</li> </ul>	YN2D24-020P-N1N2D24	2106168
	<ul style="list-style-type: none"> <li>• <b>Connection type head A:</b> Male connector, M12, 4-pin, angled, D-coded</li> <li>• <b>Connection type head B:</b> Male connector, RJ45, 4-pin, straight</li> <li>• <b>Signal type:</b> Ethernet, PROFINET</li> <li>• <b>Cable:</b> 3 m, 4-wire, PUR, halogen-free</li> <li>• <b>Description:</b> Ethernet, shielded, PROFINET</li> <li>• <b>Application:</b> Drag chain operation, Zones with oils and lubricants</li> </ul>	YN2D24-030P-N1MRJA4	2144265
	<ul style="list-style-type: none"> <li>• <b>Connection type head A:</b> Male connector, M12, 4-pin, angled, D-coded</li> <li>• <b>Connection type head B:</b> Male connector, RJ45, 4-pin, straight</li> <li>• <b>Signal type:</b> Ethernet, PROFINET</li> <li>• <b>Cable:</b> 5 m, 4-wire, PUR, halogen-free</li> <li>• <b>Description:</b> Ethernet, shielded, PROFINET</li> <li>• <b>Application:</b> Drag chain operation, Zones with oils and lubricants</li> </ul>	YN2D24-050P-N1MRJA4	2106163
	<ul style="list-style-type: none"> <li>• <b>Connection type head A:</b> Male connector, M12, 4-pin, angled, D-coded</li> <li>• <b>Connection type head B:</b> Male connector, M12, 4-pin, angled, D-coded</li> <li>• <b>Signal type:</b> Ethernet, PROFINET</li> <li>• <b>Cable:</b> 5 m, 4-wire, PUR, halogen-free</li> <li>• <b>Description:</b> Ethernet, shielded, PROFINET</li> <li>• <b>Application:</b> Drag chain operation, Zones with oils and lubricants</li> </ul>	YN2D24-050P-N1N2D24	2127662
	<ul style="list-style-type: none"> <li>• <b>Connection type head A:</b> Male connector, M12, 4-pin, angled, D-coded</li> <li>• <b>Connection type head B:</b> Flying leads</li> <li>• <b>Signal type:</b> Ethernet, PROFINET</li> <li>• <b>Cable:</b> 5 m, 4-wire, PUR, halogen-free</li> <li>• <b>Description:</b> Ethernet, shielded, PROFINET</li> <li>• <b>Application:</b> Drag chain operation, Zones with oils and lubricants</li> </ul>	YN2D24-050P-N1XLEAX	2106175
	<ul style="list-style-type: none"> <li>• <b>Connection type head A:</b> Male connector, M12, 4-pin, angled, D-coded</li> <li>• <b>Connection type head B:</b> Male connector, RJ45, 4-pin, straight</li> <li>• <b>Signal type:</b> Ethernet, PROFINET</li> <li>• <b>Cable:</b> 10 m, 4-wire, PUR, halogen-free</li> <li>• <b>Description:</b> Ethernet, shielded, PROFINET</li> <li>• <b>Application:</b> Drag chain operation, Zones with oils and lubricants</li> </ul>	YN2D24-100P-N1MRJA4	2106164
	<ul style="list-style-type: none"> <li>• <b>Connection type head A:</b> Male connector, M12, 4-pin, angled, D-coded</li> <li>• <b>Connection type head B:</b> Male connector, M12, 4-pin, angled, D-coded</li> <li>• <b>Signal type:</b> Ethernet, PROFINET</li> <li>• <b>Cable:</b> 10 m, 4-wire, PUR, halogen-free</li> <li>• <b>Description:</b> Ethernet, shielded, PROFINET</li> <li>• <b>Application:</b> Drag chain operation, Zones with oils and lubricants</li> </ul>	YN2D24-100P-N1N2D24	2106170
	<ul style="list-style-type: none"> <li>• <b>Connection type head A:</b> Male connector, M12, 4-pin, angled, D-coded</li> <li>• <b>Connection type head B:</b> Flying leads</li> <li>• <b>Signal type:</b> Ethernet, PROFINET</li> <li>• <b>Cable:</b> 10 m, 4-wire, PUR, halogen-free</li> <li>• <b>Description:</b> Ethernet, shielded, PROFINET</li> <li>• <b>Application:</b> Drag chain operation, Zones with oils and lubricants</li> </ul>	YN2D24-100P-N1XLEAX	2106176
	<ul style="list-style-type: none"> <li>• <b>Connection type head A:</b> Male connector, M12, 4-pin, angled, D-coded</li> <li>• <b>Connection type head B:</b> Male connector, RJ45, 4-pin, straight</li> <li>• <b>Signal type:</b> Ethernet, PROFINET</li> <li>• <b>Cable:</b> 20 m, 4-wire, PUR, halogen-free</li> <li>• <b>Description:</b> Ethernet, shielded, PROFINET</li> <li>• <b>Application:</b> Drag chain operation, Zones with oils and lubricants</li> </ul>	YN2D24-200P-N1MRJA4	2127664
	<ul style="list-style-type: none"> <li>• <b>Connection type head A:</b> Male connector, M12, 4-pin, angled, D-coded</li> <li>• <b>Connection type head B:</b> Flying leads</li> <li>• <b>Signal type:</b> Ethernet, PROFINET</li> <li>• <b>Cable:</b> 20 m, 4-wire, PUR, halogen-free</li> <li>• <b>Description:</b> Ethernet, shielded, PROFINET</li> </ul>	YN2D24-200P-N1XLEAX	2122743

	Brief description	Type	part no.
	<ul style="list-style-type: none"> <li>• <b>Application:</b> Drag chain operation, Zones with oils and lubricants</li> <li>• <b>Connection type head A:</b> Male connector, M12, 4-pin, angled, D-coded</li> <li>• <b>Connection type head B:</b> Flying leads</li> <li>• <b>Signal type:</b> Ethernet, PROFINET</li> <li>• <b>Cable:</b> 25 m, 4-wire, PUR, halogen-free</li> <li>• <b>Description:</b> Ethernet, shielded, PROFINET</li> <li>• <b>Application:</b> Drag chain operation, Zones with oils and lubricants</li> </ul>	YN2D24-250P-N1XLEAX	2106180
	<ul style="list-style-type: none"> <li>• <b>Description:</b> Unshielded</li> <li>• <b>Connection type head A:</b> Female connector, M12, 4-pin, angled, A-coded</li> <li>• <b>Connection systems:</b> Screw-type terminals</li> <li>• <b>Permitted cross-section:</b> ≤ 0.75 mm<sup>2</sup></li> </ul>	DOS-1204-W	6007303
	<ul style="list-style-type: none"> <li>• <b>Connection type head A:</b> Female connector, M12, 4-pin, D-coded</li> <li>• <b>Connection type head B:</b> Female connector, RJ45, 8-pin</li> <li>• <b>Signal type:</b> Ethernet</li> <li>• <b>Cable:</b> CAT5, CAT5e</li> <li>• <b>Description:</b> Ethernet, shielded</li> <li>• <b>Note:</b> Cabinet through</li> </ul>	Feedthrough female connector Ethernet RJ45	6048180

## SICK AT A GLANCE

SICK is one of the leading manufacturers of intelligent sensors and sensor solutions for industrial applications. A unique range of products and services creates the perfect basis for controlling processes securely and efficiently, protecting individuals from accidents and preventing damage to the environment.

We have extensive experience in a wide range of industries and understand their processes and requirements. With intelligent sensors, we can deliver exactly what our customers need. In application centers in Europe, Asia and North America, system solutions are tested and optimized in accordance with customer specifications. All this makes us a reliable supplier and development partner.

Comprehensive services complete our offering: SICK LifeTime Services provide support throughout the machine life cycle and ensure safety and productivity.

For us, that is “Sensor Intelligence.”

## WORLDWIDE PRESENCE:

Contacts and other locations –[www.sick.com](http://www.sick.com)