



ANM58B-BGNNB000000200AXX018X16

ANS/ANM58

ABSOLUTE ENCODERS

SICK
Sensor Intelligence.



Ordering information

Type	part no.
ANM58B-BGNNB000000200AXX018X16	1148734

Other models and accessories → www.sick.com/ANS_ANM58

Illustration may differ



Detailed technical data

Safety-related parameters

MTTF_D (mean time to dangerous failure)	165 years (EN ISO 13849-1) ¹⁾
--	--

¹⁾ This product is a standard product and does not constitute a safety component as defined in the Machinery Directive. Calculation based on nominal load of components, average ambient temperature 40 °C, frequency of use 8760 h/a. All electronic failures are considered hazardous. For more information, see document no. 8015532.

Performance

Number of steps per revolution (max. resolution)	262,144 (18 bit)
Number of revolutions	65,536 (16 bit)
Max. resolution (number of steps per revolution x number of revolutions)	18 bit x 16 bit (262,144 x 65,536)
Error limits G	0.03°
Repeatability standard deviation σ_r	0.002°

Interfaces

Communication interface	PROFINET
PROFINET version	PROFINET Version 2.3
Encoder profile	V4.2
Transmission medium	CAT-5e cable
Initialization time	5 s
Cycle time	≥ 1 ms
Process data	Position, speed, Encoder status (errors, warnings)
Parameterising data	Number of steps per revolution Total measuring range PRESET Direction of rotation Filter for speed calculation Unit for output of the speed value Round axis functionality
Available diagnostics data	Minimum and maximum temperature Maximum speed

	Power-on counter Operating hours counter power-on/motion Counter of direction changes/number of movements cw/number of movements ccw Configurable limit values with limit value monitoring
Status information	Via status LED

Electronics

Connection type	Male connector, 1x, M12, 4-pin, axial ¹⁾ Female connector, 2x, M12, 4-pin, axial ²⁾
Supply voltage	10 ... 32 V
Power consumption	≤ 3 W
Reverse polarity protection	✓
Short-circuit protection	✓

¹⁾ A-coded.

²⁾ D-coded.

Mechanics

Mechanical design	Blind hollow shaft
Shaft diameter	14 mm
Characteristics of the shaft	Front clamp
Flange type / stator coupling	Stator coupling, 2-sided, screw hole circle 63 mm
Weight	Approx. 0.5 kg
Shaft material	Stainless steel
Flange material	Aluminum
Material, stator coupling	Stainless steel
Housing material	Zinc die-cast with copper-nickel coating
Start up torque	1.5 Ncm (+20 °C)
Operating torque	< 0.6 Ncm (+20 °C)
Permissible movement static	± 0.3 mm (radial) ± 0.5 mm (axial)
Permissible movement dynamic	± 0.05 mm (radial) ± 0.1 mm (axial)
Operating speed	≤ 6,000 min ⁻¹
Moment of inertia of the rotor	125 gcm ²
Bearing lifetime	L _{mnr} 30 x 10 ⁹ revolutions ¹⁾
Angular acceleration	≤ 300,000 rad/s ²

¹⁾ The value corresponds to L 10mr (ISO/TS 16281) at 60 °C operating temperature, rotational speed: 3,000 rpm, with shaft load/shaft movement of max. 50% of the specified maximum value.

Ambient data

EMC	According to EN 61000-6-2 and EN 61000-6-3
Enclosure rating	IP67 (IEC 60529)
Permissible relative humidity	90 % (Condensation not permitted)
Operating temperature range	-40 °C ... +85 °C ¹⁾

¹⁾ Relative to the measuring point on the plug connection side, see dimensional drawing.

²⁾ Operation of the mounted encoder in resonance ranges should be avoided to prevent possible damage or malfunctions.

Storage temperature range	-40 °C ... +100 °C, without package
Resistance to shocks	200 g, 6 ms (EN 60068-2-27)
Resistance to vibration	20 g, 10 Hz ... 2,000 Hz (EN 60068-2-6) ²⁾
Operating height (above sea level)	≤ 3,000 m (70 kPa)

¹⁾ Relative to the measuring point on the plug connection side, see dimensional drawing.

²⁾ Operation of the mounted encoder in resonance ranges should be avoided to prevent possible damage or malfunctions.

Certificates

EU declaration of conformity	✓
UK declaration of conformity	✓
ACMA declaration of conformity	✓
Moroccan declaration of conformity	✓
China RoHS	✓
cULus certificate	✓
Profinet certificate	✓
Information according to Art. 3 of Data Act (Regulation EU 2023/2854)	✓

Classifications

ECLASS 5.0	27270502
ECLASS 5.1.4	27270502
ECLASS 6.0	27270590
ECLASS 6.2	27270590
ECLASS 7.0	27270502
ECLASS 8.0	27270502
ECLASS 8.1	27270502
ECLASS 9.0	27270502
ECLASS 10.0	27270502
ECLASS 11.0	27270502
ECLASS 12.0	27270502
ETIM 5.0	EC001486
ETIM 6.0	EC001486
ETIM 7.0	EC001486
ETIM 8.0	EC001486
UNSPSC 16.0901	41112113

Dimensional drawing

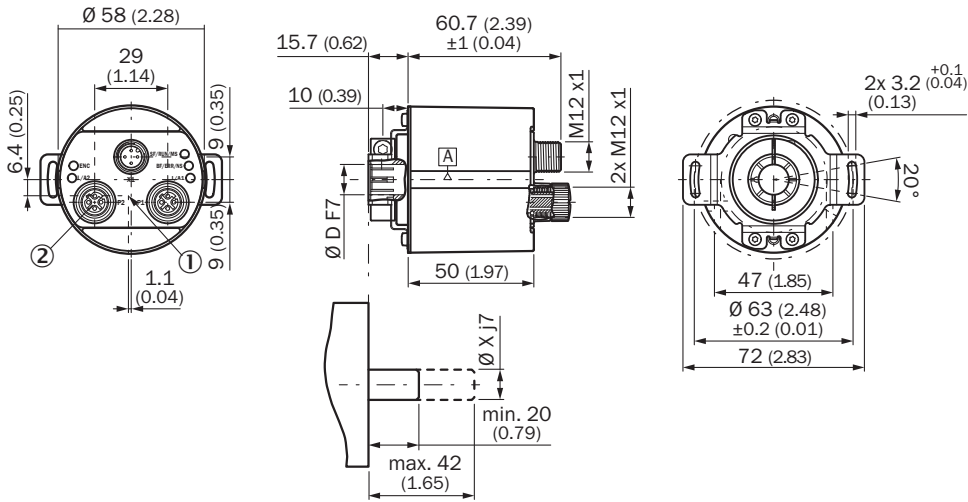

Dimensions in mm (inch)

diameter x f7 corresponds to the shaft diameter

① Operating temperature measuring point: On the plug connection side, see drawing

② Protective cap removed

Anschlussbelegung Male connector

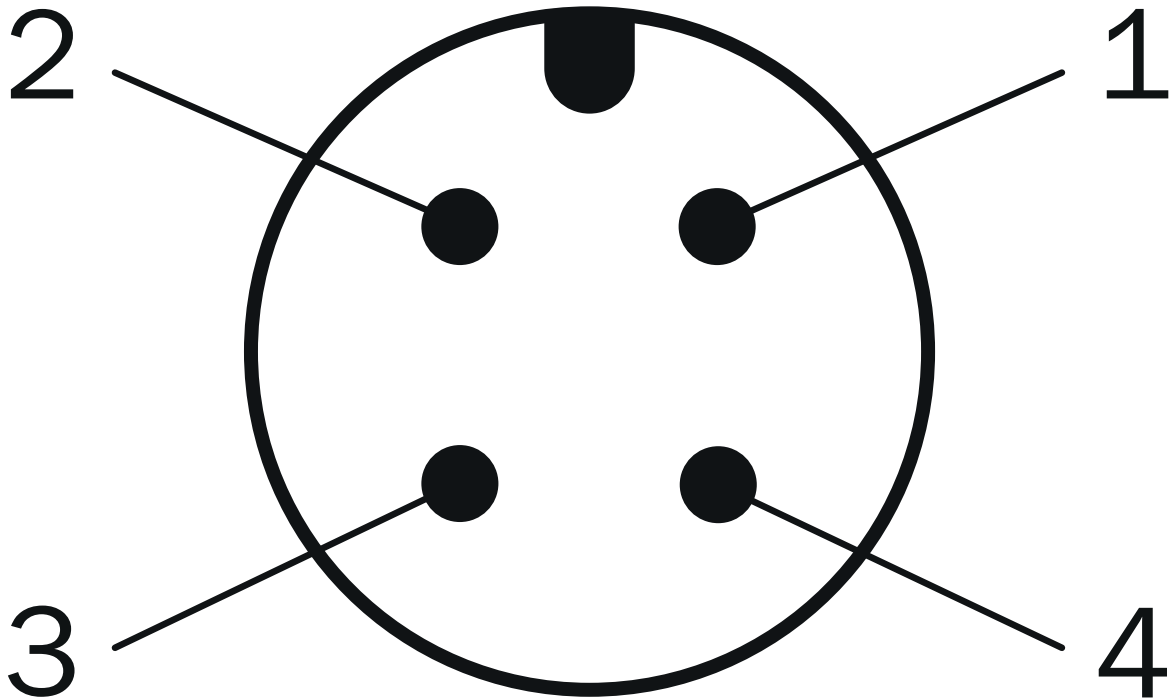

Supply voltage

PIN	Wire color	Signal
1	Brown	U _S 10 V ... 30 V
2	White	Not assigned
3	Blue	GND
4	Black	Not assigned

Anschlussbelegung Female connector

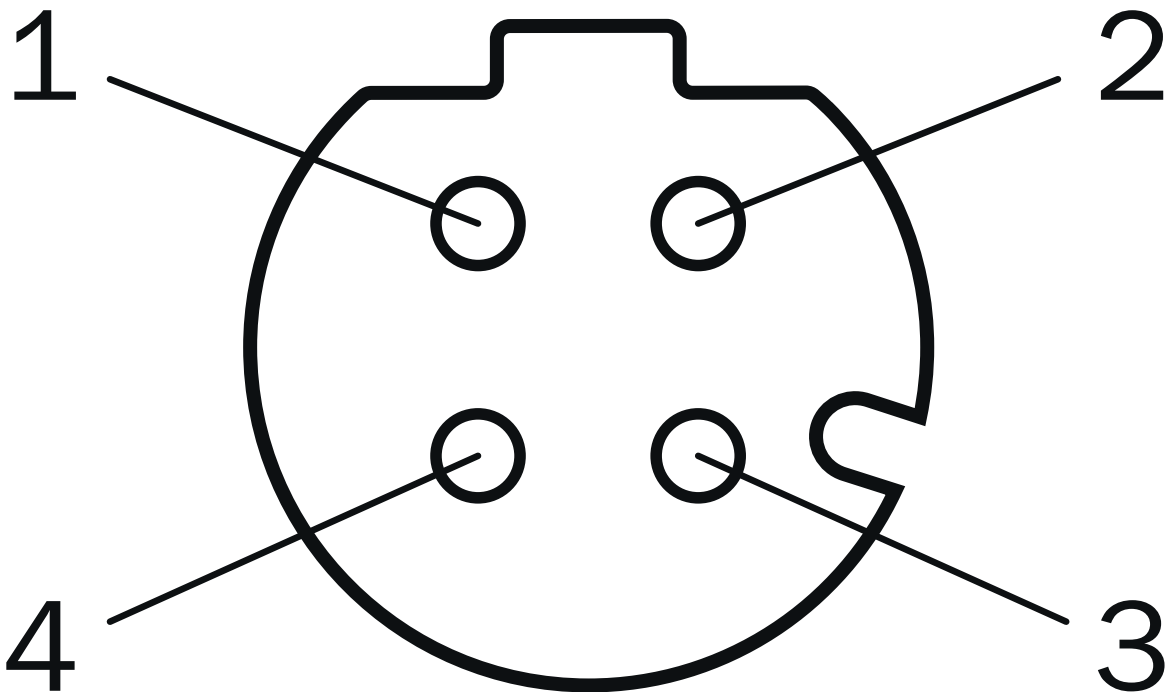





Port 1, Port 2

PIN	Wire color	Signal
1	Yellow	T x D+
2	White	R x D+
3	Orange	T x D-
4	Blue	R x D-







Recommended accessories

Other models and accessories → www.sick.com/ANS_ANM58

	Brief description	Type	part no.
connectors and cables			
	<ul style="list-style-type: none"> Description: Sensor/actuator cable, unshielded Connection type head A: Female connector, M12, 4-pin, straight, A-coded Connection type head B: Flying leads Signal type: Sensor/actuator cable Cable: 1 m, 4-wire, PUR, halogen-free Application: Drag chain operation, Zones with oils and lubricants, Robot, Drag chain operation 	YF2A14-010UB3XLEAX	2145655
	<ul style="list-style-type: none"> Description: Sensor/actuator cable, unshielded Connection type head A: Female connector, M12, 4-pin, straight, A-coded Connection type head B: Flying leads Signal type: Sensor/actuator cable Cable: 2 m, 4-wire, PUR, halogen-free Application: Drag chain operation, Zones with oils and lubricants, Robot, Drag chain operation 	YF2A14-020UB3XLEAX	2095607
	<ul style="list-style-type: none"> Description: Sensor/actuator cable, unshielded Connection type head A: Female connector, M12, 4-pin, straight, A-coded Connection type head B: Flying leads Signal type: Sensor/actuator cable Cable: 3 m, 4-wire, PUR, halogen-free Application: Drag chain operation, Zones with oils and lubricants, Robot, Drag chain operation 	YF2A14-030UB3XLEAX	2145656
	<ul style="list-style-type: none"> Description: Sensor/actuator cable, unshielded Connection type head A: Female connector, M12, 4-pin, straight, A-coded Connection type head B: Flying leads Signal type: Sensor/actuator cable Cable: 5 m, 4-wire, PUR, halogen-free Application: Drag chain operation, Zones with oils and lubricants, Robot, Drag chain operation 	YF2A14-050UB3XLEAX	2095608
	<ul style="list-style-type: none"> Description: Sensor/actuator cable, unshielded Connection type head A: Female connector, M12, 4-pin, straight, A-coded Connection type head B: Flying leads Signal type: Sensor/actuator cable Cable: 10 m, 4-wire, PUR, halogen-free Application: Drag chain operation, Zones with oils and lubricants, Robot, Drag chain operation 	YF2A14-100UB3XLEAX	2095609
	<ul style="list-style-type: none"> Description: Sensor/actuator cable, unshielded Connection type head A: Female connector, M12, 4-pin, straight, A-coded Connection type head B: Flying leads Signal type: Sensor/actuator cable Cable: 20 m, 4-wire, PUR, halogen-free Application: Drag chain operation, Zones with oils and lubricants, Robot, Drag chain operation 	YF2A14-200UB3XLEAX	2095611
	<ul style="list-style-type: none"> Description: Sensor/actuator cable, unshielded Connection type head A: Female connector, M12, 4-pin, straight, A-coded Connection type head B: Flying leads Signal type: Sensor/actuator cable Cable: 25 m, 4-wire, PUR, halogen-free Application: Drag chain operation, Zones with oils and lubricants, Robot, Drag chain operation 	YF2A14-250UB3XLEAX	2095615
	<ul style="list-style-type: none"> Description: Sensor/actuator cable, unshielded Connection type head A: Female connector, M12, 4-pin, straight, A-coded Connection type head B: Flying leads Signal type: Sensor/actuator cable Cable: 0.6 m, 4-wire, PUR, halogen-free Application: Drag chain operation, Zones with oils and lubricants, Robot, Drag chain operation 	YF2A14-C60UB3XLEAX	2145654
	<ul style="list-style-type: none"> Description: Sensor/actuator cable, unshielded Connection type head A: Female connector, M12, 4-pin, angled, A-coded Connection type head B: Flying leads Signal type: Sensor/actuator cable Cable: 1 m, 4-wire, PUR, halogen-free Application: Drag chain operation, Zones with oils and lubricants, Robot, Drag chain operation 	YG2A14-010UB3XLEAX	2145658
	<ul style="list-style-type: none"> Description: Sensor/actuator cable, unshielded Connection type head A: Female connector, M12, 4-pin, angled, A-coded Connection type head B: Flying leads Signal type: Sensor/actuator cable Cable: 2 m, 4-wire, PUR, halogen-free 	YG2A14-020UB3XLEAX	2095766

	Brief description	Type	part no.
	<ul style="list-style-type: none"> Application: Drag chain operation, Zones with oils and lubricants, Robot, Drag chain operation Description: Sensor/actuator cable, unshielded Connection type head A: Female connector, M12, 4-pin, angled, A-coded Connection type head B: Flying leads Signal type: Sensor/actuator cable Cable: 5 m, 4-wire, PUR, halogen-free Application: Drag chain operation, Zones with oils and lubricants, Robot, Drag chain operation 	YG2A14-050UB3XLEAX	2095767
	<ul style="list-style-type: none"> Description: Sensor/actuator cable, unshielded Connection type head A: Female connector, M12, 4-pin, angled, A-coded Connection type head B: Flying leads Signal type: Sensor/actuator cable Cable: 10 m, 4-wire, PUR, halogen-free Application: Drag chain operation, Zones with oils and lubricants, Robot, Drag chain operation 	YG2A14-100UB3XLEAX	2095768
	<ul style="list-style-type: none"> Description: Sensor/actuator cable, unshielded Connection type head A: Female connector, M12, 4-pin, angled, A-coded Connection type head B: Flying leads Signal type: Sensor/actuator cable Cable: 20 m, 4-wire, PUR, halogen-free Application: Drag chain operation, Zones with oils and lubricants, Robot, Drag chain operation 	YG2A14-200UB3XLEAX	2095770
	<ul style="list-style-type: none"> Description: Sensor/actuator cable, unshielded Connection type head A: Female connector, M12, 4-pin, angled, A-coded Connection type head B: Flying leads Signal type: Sensor/actuator cable Cable: 25 m, 4-wire, PUR, halogen-free Application: Drag chain operation, Zones with oils and lubricants, Robot, Drag chain operation 	YG2A14-250UB3XLEAX	2095771
	<ul style="list-style-type: none"> Connection type head A: Male connector, M12, 4-pin, straight, D-coded Connection type head B: Flying leads Signal type: Ethernet, PROFINET Cable: 2 m, 4-wire, PUR, halogen-free Description: Ethernet, shielded, PROFINET Application: Drag chain operation, Zones with oils and lubricants 	YM2D24-020P-N1XLEAX	2106171
	<ul style="list-style-type: none"> Connection type head A: Male connector, M12, 4-pin, straight, D-coded Connection type head B: Flying leads Signal type: Ethernet, PROFINET Cable: 5 m, 4-wire, PUR, halogen-free Description: Ethernet, shielded, PROFINET Application: Drag chain operation, Zones with oils and lubricants 	YM2D24-050P-N1XLEAX	2106172
	<ul style="list-style-type: none"> Connection type head A: Male connector, M12, 4-pin, straight, D-coded Connection type head B: Flying leads Signal type: Ethernet, PROFINET Cable: 10 m, 4-wire, PUR, halogen-free Description: Ethernet, shielded, PROFINET Application: Drag chain operation, Zones with oils and lubricants 	YM2D24-100P-N1XLEAX	2106173
	<ul style="list-style-type: none"> Connection type head A: Male connector, M12, 4-pin, angled, D-coded Connection type head B: Flying leads Signal type: Ethernet, PROFINET Cable: 5 m, 4-wire, PUR, halogen-free Description: Ethernet, shielded, PROFINET Application: Drag chain operation, Zones with oils and lubricants 	YN2D24-050P-N1XLEAX	2106175
	<ul style="list-style-type: none"> Connection type head A: Male connector, M12, 4-pin, angled, D-coded Connection type head B: Flying leads Signal type: Ethernet, PROFINET Cable: 10 m, 4-wire, PUR, halogen-free Description: Ethernet, shielded, PROFINET Application: Drag chain operation, Zones with oils and lubricants 	YN2D24-100P-N1XLEAX	2106176
	<ul style="list-style-type: none"> Connection type head A: Male connector, M12, 4-pin, angled, D-coded Connection type head B: Flying leads Signal type: Ethernet, PROFINET Cable: 25 m, 4-wire, PUR, halogen-free Description: Ethernet, shielded, PROFINET Application: Drag chain operation, Zones with oils and lubricants 	YN2D24-250P-N1XLEAX	2106180
	<ul style="list-style-type: none"> Connection type head A: Male connector, M12, 4-pin, straight, D-coded Connection type head B: Male connector, M12, 4-pin, angled, D-coded Signal type: Ethernet, PROFINET Cable: 2 m, 4-wire, PUR, halogen-free Description: Ethernet, shielded, PROFINET 	YM2D24-020P-N1N2D24	2106165

	Brief description	Type	part no.
	<ul style="list-style-type: none"> • Application: Drag chain operation, Zones with oils and lubricants • Connection type head A: Male connector, M12, 4-pin, straight, D-coded • Connection type head B: Male connector, M12, 4-pin, straight, D-coded • Signal type: Ethernet, PROFINET • Cable: 5 m, 4-wire, PUR, halogen-free • Description: Ethernet, shielded, PROFINET • Application: Drag chain operation, Zones with oils and lubricants 	YM2D24-050P-N1M2D24	2106160
	<ul style="list-style-type: none"> • Connection type head A: Male connector, M12, 4-pin, straight, D-coded • Connection type head B: Male connector, M12, 4-pin, angled, D-coded • Signal type: Ethernet, PROFINET • Cable: 5 m, 4-wire, PUR, halogen-free • Description: Ethernet, shielded, PROFINET • Application: Drag chain operation, Zones with oils and lubricants 	YM2D24-050P-N1N2D24	2106166
	<ul style="list-style-type: none"> • Connection type head A: Male connector, M12, 4-pin, straight, D-coded • Connection type head B: Male connector, M12, 4-pin, straight, D-coded • Signal type: Ethernet, PROFINET • Cable: 10 m, 4-wire, PUR, halogen-free • Description: Ethernet, shielded, PROFINET • Application: Drag chain operation, Zones with oils and lubricants 	YM2D24-100P-N1M2D24	2106161
	<ul style="list-style-type: none"> • Connection type head A: Male connector, M12, 4-pin, straight, D-coded • Connection type head B: Male connector, M12, 4-pin, angled, D-coded • Signal type: Ethernet, PROFINET • Cable: 10 m, 4-wire, PUR, halogen-free • Description: Ethernet, shielded, PROFINET • Application: Drag chain operation, Zones with oils and lubricants 	YM2D24-100P-N1N2D24	2106167
	<ul style="list-style-type: none"> • Connection type head A: Male connector, M12, 4-pin, angled, D-coded • Connection type head B: Male connector, M12, 4-pin, angled, D-coded • Signal type: Ethernet, PROFINET • Cable: 2 m, 4-wire, PUR, halogen-free • Description: Ethernet, shielded, PROFINET • Application: Drag chain operation, Zones with oils and lubricants 	YN2D24-020P-N1N2D24	2106168
	<ul style="list-style-type: none"> • Connection type head A: Male connector, M12, 4-pin, angled, D-coded • Connection type head B: Male connector, M12, 4-pin, angled, D-coded • Signal type: Ethernet, PROFINET • Cable: 10 m, 4-wire, PUR, halogen-free • Description: Ethernet, shielded, PROFINET • Application: Drag chain operation, Zones with oils and lubricants 	YN2D24-100P-N1N2D24	2106170
	<ul style="list-style-type: none"> • Connection type head A: Male connector, M12, 4-pin, straight, D-coded • Connection type head B: Male connector, RJ45, 4-pin, straight • Signal type: Ethernet, PROFINET • Cable: 2 m, 4-wire, PUR, halogen-free • Description: Ethernet, shielded, PROFINET • Application: Drag chain operation, Zones with oils and lubricants 	YM2D24-020P-N1MRJA4	2106182
	<ul style="list-style-type: none"> • Description: Unshielded • Connection type head A: Female connector, M12, 4-pin, angled, A-coded • Connection systems: Screw-type terminals • Permitted cross-section: ≤ 0.75 mm² 	DOS-1204-W	6007303
	<ul style="list-style-type: none"> • Description: PROFINET, shielded • Connection type head A: Male connector, M12, 4-pin, angled, D-coded • Signal type: PROFINET • Cable: CAT5, CAT5e • Connection systems: IDC quick connection • Permitted cross-section: 0.14 mm² ... 0.34 mm² 	STE-1204-WZ	6048262
	<ul style="list-style-type: none"> • Connection type head A: Male connector, M12, 4-pin, straight, D-coded • Connection type head B: Male connector, RJ45, 4-pin, straight • Signal type: Ethernet, PROFINET • Cable: 5 m, 4-wire, PUR, halogen-free • Description: Ethernet, shielded, PROFINET • Application: Drag chain operation, Zones with oils and lubricants 	YM2D24-050P-N1MRJA4	2106184
	<ul style="list-style-type: none"> • Connection type head A: Male connector, M12, 4-pin, straight, D-coded • Connection type head B: Male connector, RJ45, 4-pin, straight • Signal type: Ethernet, PROFINET • Cable: 10 m, 4-wire, PUR, halogen-free • Description: Ethernet, shielded, PROFINET • Application: Drag chain operation, Zones with oils and lubricants 	YM2D24-100P-N1MRJA4	2106185
	<ul style="list-style-type: none"> • Connection type head A: Male connector, M12, 4-pin, angled, D-coded • Connection type head B: Male connector, RJ45, 4-pin, straight • Signal type: Ethernet, PROFINET • Cable: 2 m, 4-wire, PUR, halogen-free 	YN2D24-020P-N1MRJA4	2106162

	Brief description	Type	part no.
	<ul style="list-style-type: none"> Description: Ethernet, shielded, PROFINET Application: Drag chain operation, Zones with oils and lubricants 		
	<ul style="list-style-type: none"> Connection type head A: Male connector, M12, 4-pin, angled, D-coded Connection type head B: Male connector, RJ45, 4-pin, straight Signal type: Ethernet, PROFINET Cable: 3 m, 4-wire, PUR, halogen-free Description: Ethernet, shielded, PROFINET Application: Drag chain operation, Zones with oils and lubricants 	YN2D24-030P-N1MRJA4	2144265
	<ul style="list-style-type: none"> Connection type head A: Male connector, M12, 4-pin, angled, D-coded Connection type head B: Male connector, RJ45, 4-pin, straight Signal type: Ethernet, PROFINET Cable: 5 m, 4-wire, PUR, halogen-free Description: Ethernet, shielded, PROFINET Application: Drag chain operation, Zones with oils and lubricants 	YN2D24-050P-N1MRJA4	2106163
	<ul style="list-style-type: none"> Connection type head A: Male connector, M12, 4-pin, angled, D-coded Connection type head B: Male connector, RJ45, 4-pin, straight Signal type: Ethernet, PROFINET Cable: 10 m, 4-wire, PUR, halogen-free Description: Ethernet, shielded, PROFINET Application: Drag chain operation, Zones with oils and lubricants 	YN2D24-100P-N1MRJA4	2106164
	<ul style="list-style-type: none"> Connection type head A: Male connector, M12, 4-pin, angled, D-coded Connection type head B: Male connector, RJ45, 4-pin, straight Signal type: Ethernet, PROFINET Cable: 20 m, 4-wire, PUR, halogen-free Description: Ethernet, shielded, PROFINET Application: Drag chain operation, Zones with oils and lubricants 	YN2D24-200P-N1MRJA4	2127664
	<ul style="list-style-type: none"> Connection type head A: Male connector, M12, 4-pin, angled, D-coded Connection type head B: Male connector, M12, 4-pin, angled, D-coded Signal type: Ethernet, PROFINET Cable: 5 m, 4-wire, PUR, halogen-free Description: Ethernet, shielded, PROFINET Application: Drag chain operation, Zones with oils and lubricants 	YN2D24-050P-N1N2D24	2127662
	<ul style="list-style-type: none"> Connection type head A: Male connector, RJ45, 4-pin, straight Connection type head B: Male connector, M12, 4-pin, angled, D-coded Signal type: Ethernet, PROFINET Cable: 30 m, 4-wire, CAT5, CAT5e, PVC Description: Ethernet, shielded, PROFINET 	SSL-2J04-F30MZ	6059450
	<ul style="list-style-type: none"> Connection type head A: Female connector, M12, 4-pin, D-coded Connection type head B: Female connector, RJ45, 8-pin Signal type: Ethernet Cable: CAT5, CAT5e Description: Ethernet, shielded Note: Cabinet through 	Feedthrough female connector Ethernet RJ45	6048180

SICK AT A GLANCE

SICK is one of the leading manufacturers of intelligent sensors and sensor solutions for industrial applications. A unique range of products and services creates the perfect basis for controlling processes securely and efficiently, protecting individuals from accidents and preventing damage to the environment.

We have extensive experience in a wide range of industries and understand their processes and requirements. With intelligent sensors, we can deliver exactly what our customers need. In application centers in Europe, Asia and North America, system solutions are tested and optimized in accordance with customer specifications. All this makes us a reliable supplier and development partner.

Comprehensive services complete our offering: SICK LifeTime Services provide support throughout the machine life cycle and ensure safety and productivity.

For us, that is “Sensor Intelligence.”

WORLDWIDE PRESENCE:

Contacts and other locations –www.sick.com