

SICK.COM



DATA SHEET

GLD6SP-14A1217EZZZ

G6
Photoelectric sensors

SICK Sensor Intelligence

PHOTOELECTRIC SENSORS

GLD6SP-14A1217EZZZ

ORDERING INFORMATION

Type	part no.
GLD6SP-14A1217EZZZ	1148201

Further device versions and accessories at www.sick.com/G6



Illustration may differ



DETAILED TECHNICAL DATA

FEATURES

Functional principle	Photoelectric retro-reflective sensor	
Functional principle detail	With minimum distance to reflector (dual lens system)	
Sensing range	Sensing range min.	0.03 m
	Sensing range max.	6 m
	Maximum distance range from reflector to sensor (operating reserve 1)	0.03 m ... 6 m
	Recommended distance range from reflector to sensor (operating reserve 2)	0.07 m ... 5 m
	Reference reflector	Reflector PL80A
	Recommended sensing range for the best performance	0.25 m ... 1.6 m
Polarisation filter	Yes	
Emitted beam	Light source	PinPoint LED
	Type of light	Visible red light
	Shape of light spot	Point-shaped
	Light spot size (distance)	Ø 11.5 mm (350 mm)
Key LED figures	Normative reference	EN 62471:2008-09 IEC 62471:2006, modified
	LED risk group marking	Free group
	Wave length	640 nm
	Average service life	100,000 h at T _a = +25 °C
Adjustment	Potentiometer	For setting the sensing range, 270°

	Operating mode switch	For inverting the switching function (light/dark switching)
Display	LED green	Operating indicator Static on: power on
	LED yellow	Status of received light beam Static on: object not present Static off: object present

SAFETY-RELATED PARAMETERS

MTTF _D	4,112 years
DC _{avg}	0%
T _M (mission time)	20 years

ELECTRONICS

Supply voltage U _B	10 V DC ... 30 V DC ¹⁾																
Ripple	≤ 5 V _{pp}																
Usage category	DC-12 (According to EN 60947-5-2) DC-13 (According to EN 60947-5-2)																
Current consumption	≤ 20 mA, without load. At U _B = 24 V																
Protection class	III																
Digital output	<table border="0"> <tr> <td>Number</td> <td>1</td> </tr> <tr> <td>Type</td> <td>PNP</td> </tr> <tr> <td>Switching mode</td> <td>Light/dark switching</td> </tr> <tr> <td>Signal voltage PNP HIGH/LOW</td> <td>Approx. U_B -3 V / 0 V</td> </tr> <tr> <td>Output current I_{max.}</td> <td>≤ 100 mA ²⁾</td> </tr> <tr> <td>Circuit protection outputs</td> <td>Reverse polarity protected Overcurrent protected Short-circuit protected</td> </tr> <tr> <td>Response time</td> <td>≤ 625 μs ³⁾</td> </tr> <tr> <td>Switching frequency</td> <td>1,000 Hz ⁴⁾</td> </tr> </table>	Number	1	Type	PNP	Switching mode	Light/dark switching	Signal voltage PNP HIGH/LOW	Approx. U _B -3 V / 0 V	Output current I _{max.}	≤ 100 mA ²⁾	Circuit protection outputs	Reverse polarity protected Overcurrent protected Short-circuit protected	Response time	≤ 625 μs ³⁾	Switching frequency	1,000 Hz ⁴⁾
Number	1																
Type	PNP																
Switching mode	Light/dark switching																
Signal voltage PNP HIGH/LOW	Approx. U _B -3 V / 0 V																
Output current I _{max.}	≤ 100 mA ²⁾																
Circuit protection outputs	Reverse polarity protected Overcurrent protected Short-circuit protected																
Response time	≤ 625 μs ³⁾																
Switching frequency	1,000 Hz ⁴⁾																
Pin/Wire assignment	<table border="0"> <tr> <td>Function of pin 4/black (BK)</td> <td>Digital output, light switching, object present → output Q LOW</td> </tr> <tr> <td>Function of pin 4/black (BK) – detail</td> <td>The pin 4 function of the sensor can be switched Additional possible settings via operating mode switch</td> </tr> </table>	Function of pin 4/black (BK)	Digital output, light switching, object present → output Q LOW	Function of pin 4/black (BK) – detail	The pin 4 function of the sensor can be switched Additional possible settings via operating mode switch												
Function of pin 4/black (BK)	Digital output, light switching, object present → output Q LOW																
Function of pin 4/black (BK) – detail	The pin 4 function of the sensor can be switched Additional possible settings via operating mode switch																

¹⁾ Limit values.

²⁾ At U_B > 24 V, I max. = 50 mA.

³⁾ Signal transit time with resistive load.

⁴⁾ With light/dark ratio 1:1.

MECHANICS

Housing	Rectangular								
Dimensions (W x H x D)	12 mm x 31.6 mm x 21 mm								
Connection	Cable with M12 male connector, 4-pin, 2,048 mm								
Connection detail	<table border="0"> <tr> <td>Deep-freeze property</td> <td>Do not bend below 0 °C</td> </tr> <tr> <td>Conductor size</td> <td>0.14 mm²</td> </tr> <tr> <td>Cable diameter</td> <td>Ø 3.4 mm</td> </tr> <tr> <td>Length of cable (L)</td> <td>2 m</td> </tr> </table>	Deep-freeze property	Do not bend below 0 °C	Conductor size	0.14 mm ²	Cable diameter	Ø 3.4 mm	Length of cable (L)	2 m
Deep-freeze property	Do not bend below 0 °C								
Conductor size	0.14 mm ²								
Cable diameter	Ø 3.4 mm								
Length of cable (L)	2 m								
Material	<table border="0"> <tr> <td>Housing</td> <td>Plastic, ABS</td> </tr> <tr> <td>Front screen</td> <td>Plastic, PMMA</td> </tr> <tr> <td>Cable</td> <td>Plastic, PVC</td> </tr> </table>	Housing	Plastic, ABS	Front screen	Plastic, PMMA	Cable	Plastic, PVC		
Housing	Plastic, ABS								
Front screen	Plastic, PMMA								
Cable	Plastic, PVC								

PHOTOELECTRIC SENSORS - GLD6SP-14A1217EZZZ

Male connector	Metal, copper alloy (C3604 CUZN39PB3)
Weight	Approx. 28 g
Maximum tightening torque of the fixing screws	0.4 Nm

AMBIENT DATA

Enclosure rating	IP67 (EN 60529)
Ambient operating temperature	-30 °C ... +55 °C
Ambient temperature, storage	-40 °C ... +70 °C
Typ. Ambient light immunity	Sunlight: ≤ 30,000 lx
Shock resistance	30 g, 11 ms (3 positive and 3 negative shocks along X, Y, Z axes, 18 total shocks (EN60068-2-27))
Vibration resistance	10 Hz ... 55 Hz (Amplitude 0.5 mm, 3 x 30 min (EN60068-2-6))
Air humidity	35 % ... 95 %, relative humidity (no condensation)
Electromagnetic compatibility (EMC)	EN 60947-5-2
UL File No.	NRKH.E348498 & NRKH7.E348498

CERTIFICATES

EU declaration of conformity	✓
UK declaration of conformity	✓
ACMA declaration of conformity	✓
Moroccan declaration of conformity	✓
China RoHS	✓
cULus certificate	✓
Photobiological safety (IEC EN 62471)	✓

DIMENSIONAL DRAWING

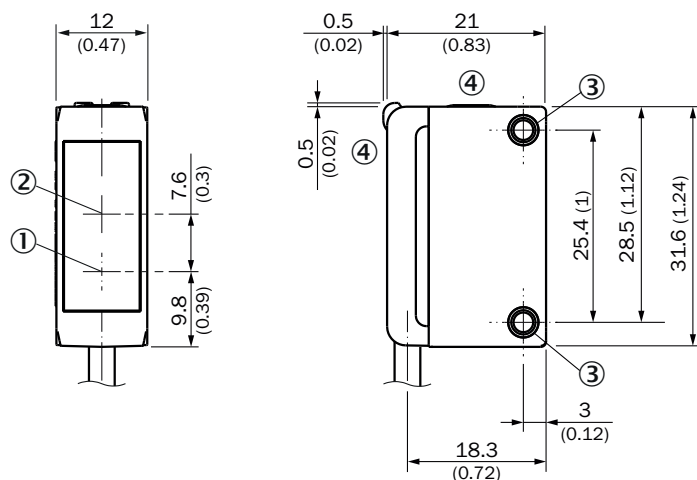

Dimensions in mm (inch)

- ① Center of optical axis, sender
- ② Center of optical axis, receiver
- ③ Mounting holes M3
- ④ display and adjustment elements

DIMENSIONAL DRAWING, CONNECTION

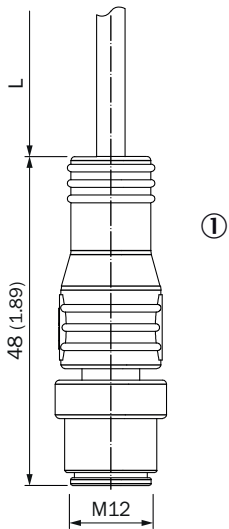

Dimensions in mm (inch)
 For length of cable (L), see technical data
 ① Cable with M12 male connector

DISPLAY AND ADJUSTMENT ELEMENTS

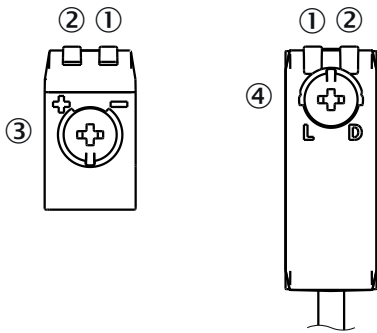

- ① LED green
- ② LED yellow
- ③ Potentiometer
- ④ operating mode switch

CONNECTION TYPE M12 MALE CONNECTOR, 4-PIN

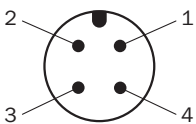

CONNECTION DIAGRAM CD-066

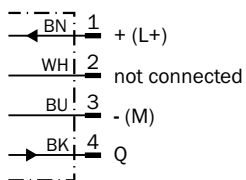

TRUTH TABLE PNP - LIGHT SWITCHING Q

	Light switching Q (normally closed)	
	Object not present → Output HIGH	Object present → Output LOW
Light receive	✓	✗
Light receive indicator	☀	✗
Load resistance	⚡	✗

CHARACTERISTIC CURVE

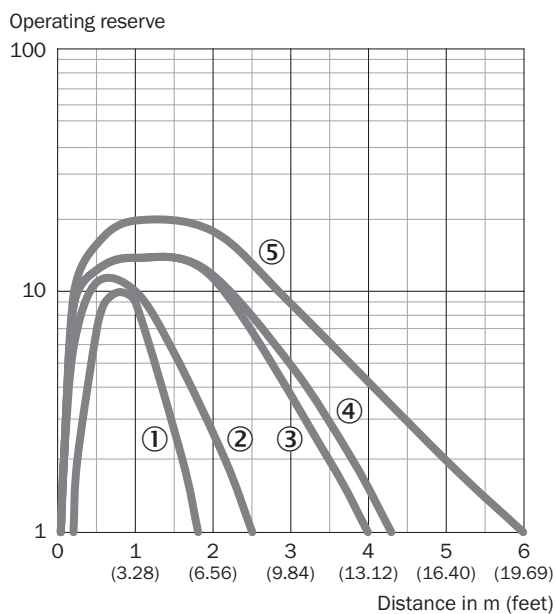

- ① Reflective tape REF-IRF-56
- ② Reflector PL20A
- ③ Reflector P250
- ④ Reflector PL40A
- ⑤ Reflector PL80A

LIGHT SPOT SIZE

Dimensions in mm (inch)

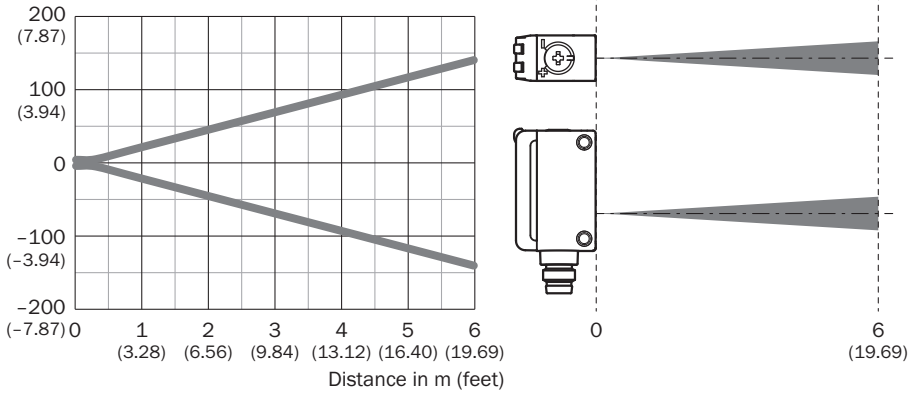

SENSING RANGE DIAGRAM

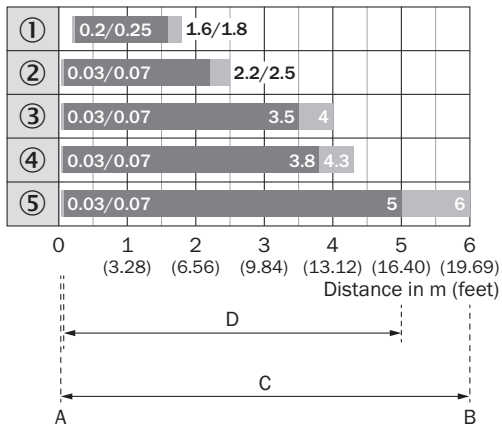

1	Reflective tape REF-IRF-56
2	Reflector PL20A
3	Reflector P250
4	Reflector PL40A
5	Reflector PL80A
A	Sensing range min. in m
B	Sensing range max. in m
C	Maximum distance range from reflector to sensor (operating reserve 1)
D	Recommended distance range from reflector to sensor (operating reserve 2)

Further information as well as suitable accessories, example applications and downloads such as CAD dimensional models, operating instructions and software can be found at www.sick.com/1148201



SICK AG
WALDKIRCH
GERMANY
SICK.COM

SICK AT A GLANCE

SICK is a leading global technology company for intelligent sensors and integrated solutions in industrial automation. Our technologies set benchmarks, making your industrial processes more efficient, safer and more sustainable – both in logistics and manufacturing operations.

SICK combines sensor intelligence with industry expertise and certified consulting services. We provide the ideal foundation for scalable as well as tailor-made automation solutions and create added value along the entire value chain. Our close partnerships with our customers are more than just a promise: Together, we optimize productivity, improve quality, protect health and safety, and help build a sustainable future. All with empathy and trust.

Since 1946, we have been developing innovative technologies with passion and a pioneering spirit. With a global network in around 40 countries, SICK has a global presence and is always close by. The company's headquarters are located in Waldkirch near Freiburg, Germany. Our customers benefit from our understanding of both local and global requirements, which enables us to deliver tailor-made solutions

SICK
Sensor Intelligence