



# ANM58B-TINNA000000500AXX018X16

ANS/ANM58

**ABSOLUTE ENCODERS**

**SICK**  
Sensor Intelligence.



Illustration may differ



### Ordering information

Type	part no.
ANM58B-TINNA000000500AXX018X16	1146657

Other models and accessories → [www.sick.com/ANS\\_ANM58](http://www.sick.com/ANS_ANM58)

### Detailed technical data

#### Safety-related parameters

<b>MTTF<sub>D</sub> (mean time to dangerous failure)</b>	165 years (EN ISO 13849-1) <sup>1)</sup>
--	--

<sup>1)</sup> This product is a standard product and does not constitute a safety component as defined in the Machinery Directive. Calculation based on nominal load of components, average ambient temperature 40 °C, frequency of use 8760 h/a. All electronic failures are considered hazardous. For more information, see document no. 8015532.

#### Performance

<b>Number of steps per revolution (max. resolution)</b>	262,144 (18 bit)
<b>Number of revolutions</b>	65,536 (16 bit)
<b>Max. resolution (number of steps per revolution x number of revolutions)</b>	18 bit x 16 bit (262,144 x 65,536)
<b>Error limits G</b>	0.03°
<b>Repeatability standard deviation <math>\sigma_r</math></b>	0.002°

#### Interfaces

<b>Communication interface</b>	PROFINET
<b>PROFINET version</b>	PROFINET Version 2.3
<b>Encoder profile</b>	V4.2
<b>Transmission medium</b>	CAT-5e cable
<b>Initialization time</b>	5 s
<b>Cycle time</b>	≥ 1 ms
<b>Process data</b>	Position, speed, Encoder status (errors, warnings)
<b>Parameterising data</b>	Number of steps per revolution Total measuring range PRESET Direction of rotation Filter for speed calculation Unit for output of the speed value

	Round axis functionality
<b>Available diagnostics data</b>	Minimum and maximum temperature Maximum speed Power-on counter Operating hours counter power-on/motion Counter of direction changes/number of movements cw/number of movements ccw Configurable limit values with limit value monitoring
<b>Status information</b>	Via status LED

## Electronics

<b>Connection type</b>	Male connector, 1x, M12, 4-pin, radial <sup>1)</sup> Female connector, 2x, M12, 4-pin, radial <sup>2)</sup>
<b>Supply voltage</b>	10 ... 32 V
<b>Power consumption</b>	≤ 3 W
<b>Reverse polarity protection</b>	✓
<b>Short-circuit protection</b>	✓

<sup>1)</sup> A-coded.<sup>2)</sup> D-coded.

## Mechanics

<b>Mechanical design</b>	Through hollow shaft
<b>Shaft diameter</b>	16 mm
<b>Characteristics of the shaft</b>	Front clamp
<b>Flange type / stator coupling</b>	Stator coupling, 2-sided, screw hole circle 63 mm
<b>Weight</b>	Approx. 0.5 kg
<b>Shaft material</b>	Stainless steel
<b>Flange material</b>	Aluminum
<b>Material, stator coupling</b>	Stainless steel
<b>Housing material</b>	Zinc die-cast with copper-nickel coating
<b>Start up torque</b>	4.6 Ncm (+20 °C)
<b>Operating torque</b>	1.5 Ncm (+20 °C)
<b>Permissible movement static</b>	± 0.3 mm (radial) ± 0.5 mm (axial)
<b>Permissible movement dynamic</b>	± 0.05 mm (radial) ± 0.1 mm (axial)
<b>Operating speed</b>	≤ 4,000 min <sup>-1</sup>
<b>Moment of inertia of the rotor</b>	125 gcm <sup>2</sup>
<b>Bearing lifetime</b>	$L_{mnr} 30 \times 10^9$ revolutions <sup>1)</sup>
<b>Angular acceleration</b>	≤ 300,000 rad/s <sup>2</sup>

<sup>1)</sup> The value corresponds to L 10mr (ISO/TS 16281) at 60 °C operating temperature, rotational speed: 3,000 rpm, with shaft load/shaft movement of max. 50% of the specified maximum value.

## Ambient data

<b>EMC</b>	According to EN 61000-6-2 and EN 61000-6-3
<b>Enclosure rating</b>	IP67 (IEC 60529)

<sup>1)</sup> Relative to the measuring point on the plug connection side, see dimensional drawing.

<sup>2)</sup> Operation of the mounted encoder in resonance ranges should be avoided to prevent possible damage or malfunctions.

<b>Permissible relative humidity</b>	90 % (Condensation not permitted)
<b>Operating temperature range</b>	-40 °C ... +85 °C <sup>1)</sup>
<b>Storage temperature range</b>	-40 °C ... +100 °C, without package
<b>Resistance to shocks</b>	100 g, 6 ms (EN 60068-2-27)
<b>Resistance to vibration</b>	10 g, 10 Hz ... 2,000 Hz (EN 60068-2-6) <sup>2)</sup>
<b>Operating height (above sea level)</b>	≤ 3,000 m (70 kPa)

<sup>1)</sup> Relative to the measuring point on the plug connection side, see dimensional drawing.

<sup>2)</sup> Operation of the mounted encoder in resonance ranges should be avoided to prevent possible damage or malfunctions.

### Certificates

<b>EU declaration of conformity</b>	✓
<b>UK declaration of conformity</b>	✓
<b>ACMA declaration of conformity</b>	✓
<b>Moroccan declaration of conformity</b>	✓
<b>China RoHS</b>	✓
<b>cULus certificate</b>	✓
<b>Profinet certificate</b>	✓
<b>Information according to Art. 3 of Data Act (Regulation EU 2023/2854)</b>	✓

### Classifications

<b>ECLASS 5.0</b>	27270502
<b>ECLASS 5.1.4</b>	27270502
<b>ECLASS 6.0</b>	27270590
<b>ECLASS 6.2</b>	27270590
<b>ECLASS 7.0</b>	27270502
<b>ECLASS 8.0</b>	27270502
<b>ECLASS 8.1</b>	27270502
<b>ECLASS 9.0</b>	27270502
<b>ECLASS 10.0</b>	27270502
<b>ECLASS 11.0</b>	27270502
<b>ECLASS 12.0</b>	27270502
<b>ETIM 5.0</b>	EC001486
<b>ETIM 6.0</b>	EC001486
<b>ETIM 7.0</b>	EC001486
<b>ETIM 8.0</b>	EC001486
<b>UNSPSC 16.0901</b>	41112113

Dimensional drawing

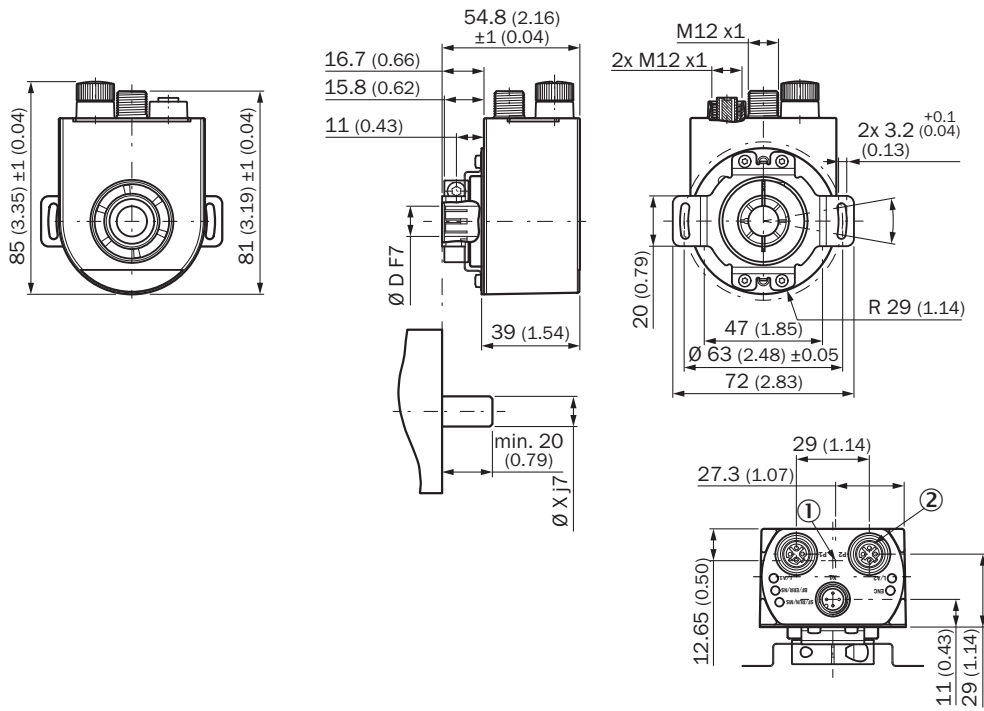

Dimensions in mm (inch)

diameter x f7 corresponds to the shaft diameter

① Operating temperature measuring point: On the plug connection side, see drawing

② Protective cap removed

Anschlussbelegung Male connector



Supply voltage

PIN	Wire color	Signal
1	Brown	U <sub>S</sub> 10 V ... 30 V
2	White	Not assigned
3	Blue	GND
4	Black	Not assigned

## Anschlussbelegung Female connector



Port 1, Port 2

PIN	Wire color	Signal
1	Yellow	T x D+
2	White	R x D+
3	Orange	T x D-
4	Blue	R x D-







### Recommended accessories

Other models and accessories → [www.sick.com/ANS\\_ANM58](http://www.sick.com/ANS_ANM58)

	Brief description	Type	part no.
connectors and cables			
	<ul style="list-style-type: none"> <li><b>Description:</b> Sensor/actuator cable, unshielded</li> <li><b>Connection type head A:</b> Female connector, M12, 4-pin, straight, A-coded</li> <li><b>Connection type head B:</b> Flying leads</li> <li><b>Signal type:</b> Sensor/actuator cable</li> <li><b>Cable:</b> 1 m, 4-wire, PUR, halogen-free</li> <li><b>Application:</b> Drag chain operation, Zones with oils and lubricants, Robot, Drag chain operation</li> </ul>	YF2A14-010UB3XLEAX	2145655
	<ul style="list-style-type: none"> <li><b>Description:</b> Sensor/actuator cable, unshielded</li> <li><b>Connection type head A:</b> Female connector, M12, 4-pin, straight, A-coded</li> <li><b>Connection type head B:</b> Flying leads</li> <li><b>Signal type:</b> Sensor/actuator cable</li> <li><b>Cable:</b> 2 m, 4-wire, PUR, halogen-free</li> <li><b>Application:</b> Drag chain operation, Zones with oils and lubricants, Robot, Drag chain operation</li> </ul>	YF2A14-020UB3XLEAX	2095607
	<ul style="list-style-type: none"> <li><b>Description:</b> Sensor/actuator cable, unshielded</li> <li><b>Connection type head A:</b> Female connector, M12, 4-pin, straight, A-coded</li> <li><b>Connection type head B:</b> Flying leads</li> <li><b>Signal type:</b> Sensor/actuator cable</li> <li><b>Cable:</b> 3 m, 4-wire, PUR, halogen-free</li> <li><b>Application:</b> Drag chain operation, Zones with oils and lubricants, Robot, Drag chain operation</li> </ul>	YF2A14-030UB3XLEAX	2145656
	<ul style="list-style-type: none"> <li><b>Description:</b> Sensor/actuator cable, unshielded</li> <li><b>Connection type head A:</b> Female connector, M12, 4-pin, straight, A-coded</li> <li><b>Connection type head B:</b> Flying leads</li> <li><b>Signal type:</b> Sensor/actuator cable</li> <li><b>Cable:</b> 5 m, 4-wire, PUR, halogen-free</li> <li><b>Application:</b> Drag chain operation, Zones with oils and lubricants, Robot, Drag chain operation</li> </ul>	YF2A14-050UB3XLEAX	2095608
	<ul style="list-style-type: none"> <li><b>Description:</b> Sensor/actuator cable, unshielded</li> <li><b>Connection type head A:</b> Female connector, M12, 4-pin, straight, A-coded</li> <li><b>Connection type head B:</b> Flying leads</li> <li><b>Signal type:</b> Sensor/actuator cable</li> <li><b>Cable:</b> 10 m, 4-wire, PUR, halogen-free</li> <li><b>Application:</b> Drag chain operation, Zones with oils and lubricants, Robot, Drag chain operation</li> </ul>	YF2A14-100UB3XLEAX	2095609
	<ul style="list-style-type: none"> <li><b>Description:</b> Sensor/actuator cable, unshielded</li> <li><b>Connection type head A:</b> Female connector, M12, 4-pin, straight, A-coded</li> <li><b>Connection type head B:</b> Flying leads</li> <li><b>Signal type:</b> Sensor/actuator cable</li> <li><b>Cable:</b> 20 m, 4-wire, PUR, halogen-free</li> <li><b>Application:</b> Drag chain operation, Zones with oils and lubricants, Robot, Drag chain operation</li> </ul>	YF2A14-200UB3XLEAX	2095611
	<ul style="list-style-type: none"> <li><b>Description:</b> Sensor/actuator cable, unshielded</li> <li><b>Connection type head A:</b> Female connector, M12, 4-pin, straight, A-coded</li> <li><b>Connection type head B:</b> Flying leads</li> <li><b>Signal type:</b> Sensor/actuator cable</li> <li><b>Cable:</b> 25 m, 4-wire, PUR, halogen-free</li> <li><b>Application:</b> Drag chain operation, Zones with oils and lubricants, Robot, Drag chain operation</li> </ul>	YF2A14-250UB3XLEAX	2095615
	<ul style="list-style-type: none"> <li><b>Description:</b> Sensor/actuator cable, unshielded</li> <li><b>Connection type head A:</b> Female connector, M12, 4-pin, straight, A-coded</li> <li><b>Connection type head B:</b> Flying leads</li> <li><b>Signal type:</b> Sensor/actuator cable</li> <li><b>Cable:</b> 0.6 m, 4-wire, PUR, halogen-free</li> <li><b>Application:</b> Drag chain operation, Zones with oils and lubricants, Robot, Drag chain operation</li> </ul>	YF2A14-C60UB3XLEAX	2145654
	<ul style="list-style-type: none"> <li><b>Description:</b> Sensor/actuator cable, unshielded</li> <li><b>Connection type head A:</b> Female connector, M12, 4-pin, angled, A-coded</li> <li><b>Connection type head B:</b> Flying leads</li> <li><b>Signal type:</b> Sensor/actuator cable</li> <li><b>Cable:</b> 1 m, 4-wire, PUR, halogen-free</li> <li><b>Application:</b> Drag chain operation, Zones with oils and lubricants, Robot, Drag chain operation</li> </ul>	YG2A14-010UB3XLEAX	2145658
	<ul style="list-style-type: none"> <li><b>Description:</b> Sensor/actuator cable, unshielded</li> <li><b>Connection type head A:</b> Female connector, M12, 4-pin, angled, A-coded</li> <li><b>Connection type head B:</b> Flying leads</li> <li><b>Signal type:</b> Sensor/actuator cable</li> <li><b>Cable:</b> 2 m, 4-wire, PUR, halogen-free</li> </ul>	YG2A14-020UB3XLEAX	2095766

	Brief description	Type	part no.
	<ul style="list-style-type: none"> <li><b>Application:</b> Drag chain operation, Zones with oils and lubricants, Robot, Drag chain operation</li> <li><b>Description:</b> Sensor/actuator cable, unshielded</li> <li><b>Connection type head A:</b> Female connector, M12, 4-pin, angled, A-coded</li> <li><b>Connection type head B:</b> Flying leads</li> <li><b>Signal type:</b> Sensor/actuator cable</li> <li><b>Cable:</b> 5 m, 4-wire, PUR, halogen-free</li> <li><b>Application:</b> Drag chain operation, Zones with oils and lubricants, Robot, Drag chain operation</li> </ul>	YG2A14-050UB3XLEAX	2095767
	<ul style="list-style-type: none"> <li><b>Description:</b> Sensor/actuator cable, unshielded</li> <li><b>Connection type head A:</b> Female connector, M12, 4-pin, angled, A-coded</li> <li><b>Connection type head B:</b> Flying leads</li> <li><b>Signal type:</b> Sensor/actuator cable</li> <li><b>Cable:</b> 10 m, 4-wire, PUR, halogen-free</li> <li><b>Application:</b> Drag chain operation, Zones with oils and lubricants, Robot, Drag chain operation</li> </ul>	YG2A14-100UB3XLEAX	2095768
	<ul style="list-style-type: none"> <li><b>Description:</b> Sensor/actuator cable, unshielded</li> <li><b>Connection type head A:</b> Female connector, M12, 4-pin, angled, A-coded</li> <li><b>Connection type head B:</b> Flying leads</li> <li><b>Signal type:</b> Sensor/actuator cable</li> <li><b>Cable:</b> 20 m, 4-wire, PUR, halogen-free</li> <li><b>Application:</b> Drag chain operation, Zones with oils and lubricants, Robot, Drag chain operation</li> </ul>	YG2A14-200UB3XLEAX	2095770
	<ul style="list-style-type: none"> <li><b>Description:</b> Sensor/actuator cable, unshielded</li> <li><b>Connection type head A:</b> Female connector, M12, 4-pin, angled, A-coded</li> <li><b>Connection type head B:</b> Flying leads</li> <li><b>Signal type:</b> Sensor/actuator cable</li> <li><b>Cable:</b> 25 m, 4-wire, PUR, halogen-free</li> <li><b>Application:</b> Drag chain operation, Zones with oils and lubricants, Robot, Drag chain operation</li> </ul>	YG2A14-250UB3XLEAX	2095771
	<ul style="list-style-type: none"> <li><b>Connection type head A:</b> Male connector, M12, 4-pin, straight, D-coded</li> <li><b>Connection type head B:</b> Flying leads</li> <li><b>Signal type:</b> Ethernet, PROFINET</li> <li><b>Cable:</b> 2 m, 4-wire, PUR, halogen-free</li> <li><b>Description:</b> Ethernet, shielded, PROFINET</li> <li><b>Application:</b> Drag chain operation, Zones with oils and lubricants</li> </ul>	YM2D24-020P-N1XLEAX	2106171
	<ul style="list-style-type: none"> <li><b>Connection type head A:</b> Male connector, M12, 4-pin, straight, D-coded</li> <li><b>Connection type head B:</b> Flying leads</li> <li><b>Signal type:</b> Ethernet, PROFINET</li> <li><b>Cable:</b> 5 m, 4-wire, PUR, halogen-free</li> <li><b>Description:</b> Ethernet, shielded, PROFINET</li> <li><b>Application:</b> Drag chain operation, Zones with oils and lubricants</li> </ul>	YM2D24-050P-N1XLEAX	2106172
	<ul style="list-style-type: none"> <li><b>Connection type head A:</b> Male connector, M12, 4-pin, straight, D-coded</li> <li><b>Connection type head B:</b> Flying leads</li> <li><b>Signal type:</b> Ethernet, PROFINET</li> <li><b>Cable:</b> 10 m, 4-wire, PUR, halogen-free</li> <li><b>Description:</b> Ethernet, shielded, PROFINET</li> <li><b>Application:</b> Drag chain operation, Zones with oils and lubricants</li> </ul>	YM2D24-100P-N1XLEAX	2106173
	<ul style="list-style-type: none"> <li><b>Connection type head A:</b> Male connector, M12, 4-pin, angled, D-coded</li> <li><b>Connection type head B:</b> Flying leads</li> <li><b>Signal type:</b> Ethernet, PROFINET</li> <li><b>Cable:</b> 5 m, 4-wire, PUR, halogen-free</li> <li><b>Description:</b> Ethernet, shielded, PROFINET</li> <li><b>Application:</b> Drag chain operation, Zones with oils and lubricants</li> </ul>	YN2D24-050P-N1XLEAX	2106175
	<ul style="list-style-type: none"> <li><b>Connection type head A:</b> Male connector, M12, 4-pin, angled, D-coded</li> <li><b>Connection type head B:</b> Flying leads</li> <li><b>Signal type:</b> Ethernet, PROFINET</li> <li><b>Cable:</b> 10 m, 4-wire, PUR, halogen-free</li> <li><b>Description:</b> Ethernet, shielded, PROFINET</li> <li><b>Application:</b> Drag chain operation, Zones with oils and lubricants</li> </ul>	YN2D24-100P-N1XLEAX	2106176
	<ul style="list-style-type: none"> <li><b>Connection type head A:</b> Male connector, M12, 4-pin, angled, D-coded</li> <li><b>Connection type head B:</b> Flying leads</li> <li><b>Signal type:</b> Ethernet, PROFINET</li> <li><b>Cable:</b> 25 m, 4-wire, PUR, halogen-free</li> <li><b>Description:</b> Ethernet, shielded, PROFINET</li> <li><b>Application:</b> Drag chain operation, Zones with oils and lubricants</li> </ul>	YN2D24-250P-N1XLEAX	2106180
	<ul style="list-style-type: none"> <li><b>Connection type head A:</b> Male connector, M12, 4-pin, straight, D-coded</li> <li><b>Connection type head B:</b> Male connector, M12, 4-pin, angled, D-coded</li> <li><b>Signal type:</b> Ethernet, PROFINET</li> <li><b>Cable:</b> 2 m, 4-wire, PUR, halogen-free</li> <li><b>Description:</b> Ethernet, shielded, PROFINET</li> </ul>	YM2D24-020P-N1N2D24	2106165

	Brief description	Type	part no.
	<ul style="list-style-type: none"> <li><b>Application:</b> Drag chain operation, Zones with oils and lubricants</li> <li><b>Connection type head A:</b> Male connector, M12, 4-pin, straight, D-coded</li> <li><b>Connection type head B:</b> Male connector, M12, 4-pin, straight, D-coded</li> <li><b>Signal type:</b> Ethernet, PROFINET</li> <li><b>Cable:</b> 5 m, 4-wire, PUR, halogen-free</li> <li><b>Description:</b> Ethernet, shielded, PROFINET</li> <li><b>Application:</b> Drag chain operation, Zones with oils and lubricants</li> </ul>	YM2D24-050P-N1M2D24	2106160
	<ul style="list-style-type: none"> <li><b>Connection type head A:</b> Male connector, M12, 4-pin, straight, D-coded</li> <li><b>Connection type head B:</b> Male connector, M12, 4-pin, angled, D-coded</li> <li><b>Signal type:</b> Ethernet, PROFINET</li> <li><b>Cable:</b> 5 m, 4-wire, PUR, halogen-free</li> <li><b>Description:</b> Ethernet, shielded, PROFINET</li> <li><b>Application:</b> Drag chain operation, Zones with oils and lubricants</li> </ul>	YM2D24-050P-N1N2D24	2106166
	<ul style="list-style-type: none"> <li><b>Connection type head A:</b> Male connector, M12, 4-pin, straight, D-coded</li> <li><b>Connection type head B:</b> Male connector, M12, 4-pin, straight, D-coded</li> <li><b>Signal type:</b> Ethernet, PROFINET</li> <li><b>Cable:</b> 10 m, 4-wire, PUR, halogen-free</li> <li><b>Description:</b> Ethernet, shielded, PROFINET</li> <li><b>Application:</b> Drag chain operation, Zones with oils and lubricants</li> </ul>	YM2D24-100P-N1M2D24	2106161
	<ul style="list-style-type: none"> <li><b>Connection type head A:</b> Male connector, M12, 4-pin, straight, D-coded</li> <li><b>Connection type head B:</b> Male connector, M12, 4-pin, angled, D-coded</li> <li><b>Signal type:</b> Ethernet, PROFINET</li> <li><b>Cable:</b> 10 m, 4-wire, PUR, halogen-free</li> <li><b>Description:</b> Ethernet, shielded, PROFINET</li> <li><b>Application:</b> Drag chain operation, Zones with oils and lubricants</li> </ul>	YM2D24-100P-N1N2D24	2106167
	<ul style="list-style-type: none"> <li><b>Connection type head A:</b> Male connector, M12, 4-pin, angled, D-coded</li> <li><b>Connection type head B:</b> Male connector, M12, 4-pin, angled, D-coded</li> <li><b>Signal type:</b> Ethernet, PROFINET</li> <li><b>Cable:</b> 2 m, 4-wire, PUR, halogen-free</li> <li><b>Description:</b> Ethernet, shielded, PROFINET</li> <li><b>Application:</b> Drag chain operation, Zones with oils and lubricants</li> </ul>	YN2D24-020P-N1N2D24	2106168
	<ul style="list-style-type: none"> <li><b>Connection type head A:</b> Male connector, M12, 4-pin, angled, D-coded</li> <li><b>Connection type head B:</b> Male connector, M12, 4-pin, angled, D-coded</li> <li><b>Signal type:</b> Ethernet, PROFINET</li> <li><b>Cable:</b> 10 m, 4-wire, PUR, halogen-free</li> <li><b>Description:</b> Ethernet, shielded, PROFINET</li> <li><b>Application:</b> Drag chain operation, Zones with oils and lubricants</li> </ul>	YN2D24-100P-N1N2D24	2106170
	<ul style="list-style-type: none"> <li><b>Connection type head A:</b> Male connector, M12, 4-pin, straight, D-coded</li> <li><b>Connection type head B:</b> Male connector, RJ45, 4-pin, straight</li> <li><b>Signal type:</b> Ethernet, PROFINET</li> <li><b>Cable:</b> 2 m, 4-wire, PUR, halogen-free</li> <li><b>Description:</b> Ethernet, shielded, PROFINET</li> <li><b>Application:</b> Drag chain operation, Zones with oils and lubricants</li> </ul>	YM2D24-020P-N1MRJA4	2106182
	<ul style="list-style-type: none"> <li><b>Description:</b> Unshielded</li> <li><b>Connection type head A:</b> Female connector, M12, 4-pin, angled, A-coded</li> <li><b>Connection systems:</b> Screw-type terminals</li> <li><b>Permitted cross-section:</b> ≤ 0.75 mm<sup>2</sup></li> </ul>	DOS-1204-W	6007303
	<ul style="list-style-type: none"> <li><b>Description:</b> PROFINET, shielded</li> <li><b>Connection type head A:</b> Male connector, M12, 4-pin, angled, D-coded</li> <li><b>Signal type:</b> PROFINET</li> <li><b>Cable:</b> CAT5, CAT5e</li> <li><b>Connection systems:</b> IDC quick connection</li> <li><b>Permitted cross-section:</b> 0.14 mm<sup>2</sup> ... 0.34 mm<sup>2</sup></li> </ul>	STE-1204-WZ	6048262
	<ul style="list-style-type: none"> <li><b>Connection type head A:</b> Male connector, M12, 4-pin, straight, D-coded</li> <li><b>Connection type head B:</b> Male connector, RJ45, 4-pin, straight</li> <li><b>Signal type:</b> Ethernet, PROFINET</li> <li><b>Cable:</b> 5 m, 4-wire, PUR, halogen-free</li> <li><b>Description:</b> Ethernet, shielded, PROFINET</li> <li><b>Application:</b> Drag chain operation, Zones with oils and lubricants</li> </ul>	YM2D24-050P-N1MRJA4	2106184
	<ul style="list-style-type: none"> <li><b>Connection type head A:</b> Male connector, M12, 4-pin, straight, D-coded</li> <li><b>Connection type head B:</b> Male connector, RJ45, 4-pin, straight</li> <li><b>Signal type:</b> Ethernet, PROFINET</li> <li><b>Cable:</b> 10 m, 4-wire, PUR, halogen-free</li> <li><b>Description:</b> Ethernet, shielded, PROFINET</li> <li><b>Application:</b> Drag chain operation, Zones with oils and lubricants</li> </ul>	YM2D24-100P-N1MRJA4	2106185
	<ul style="list-style-type: none"> <li><b>Connection type head A:</b> Male connector, M12, 4-pin, angled, D-coded</li> <li><b>Connection type head B:</b> Male connector, RJ45, 4-pin, straight</li> <li><b>Signal type:</b> Ethernet, PROFINET</li> <li><b>Cable:</b> 2 m, 4-wire, PUR, halogen-free</li> </ul>	YN2D24-020P-N1MRJA4	2106162

	Brief description	Type	part no.
	<ul style="list-style-type: none"> <li><b>Description:</b> Ethernet, shielded, PROFINET</li> <li><b>Application:</b> Drag chain operation, Zones with oils and lubricants</li> </ul>		
	<ul style="list-style-type: none"> <li><b>Connection type head A:</b> Male connector, M12, 4-pin, angled, D-coded</li> <li><b>Connection type head B:</b> Male connector, RJ45, 4-pin, straight</li> <li><b>Signal type:</b> Ethernet, PROFINET</li> <li><b>Cable:</b> 3 m, 4-wire, PUR, halogen-free</li> <li><b>Description:</b> Ethernet, shielded, PROFINET</li> <li><b>Application:</b> Drag chain operation, Zones with oils and lubricants</li> </ul>	YN2D24-030P-N1MRJA4	2144265
	<ul style="list-style-type: none"> <li><b>Connection type head A:</b> Male connector, M12, 4-pin, angled, D-coded</li> <li><b>Connection type head B:</b> Male connector, RJ45, 4-pin, straight</li> <li><b>Signal type:</b> Ethernet, PROFINET</li> <li><b>Cable:</b> 5 m, 4-wire, PUR, halogen-free</li> <li><b>Description:</b> Ethernet, shielded, PROFINET</li> <li><b>Application:</b> Drag chain operation, Zones with oils and lubricants</li> </ul>	YN2D24-050P-N1MRJA4	2106163
	<ul style="list-style-type: none"> <li><b>Connection type head A:</b> Male connector, M12, 4-pin, angled, D-coded</li> <li><b>Connection type head B:</b> Male connector, RJ45, 4-pin, straight</li> <li><b>Signal type:</b> Ethernet, PROFINET</li> <li><b>Cable:</b> 10 m, 4-wire, PUR, halogen-free</li> <li><b>Description:</b> Ethernet, shielded, PROFINET</li> <li><b>Application:</b> Drag chain operation, Zones with oils and lubricants</li> </ul>	YN2D24-100P-N1MRJA4	2106164
	<ul style="list-style-type: none"> <li><b>Connection type head A:</b> Male connector, M12, 4-pin, angled, D-coded</li> <li><b>Connection type head B:</b> Male connector, RJ45, 4-pin, straight</li> <li><b>Signal type:</b> Ethernet, PROFINET</li> <li><b>Cable:</b> 20 m, 4-wire, PUR, halogen-free</li> <li><b>Description:</b> Ethernet, shielded, PROFINET</li> <li><b>Application:</b> Drag chain operation, Zones with oils and lubricants</li> </ul>	YN2D24-200P-N1MRJA4	2127664
	<ul style="list-style-type: none"> <li><b>Connection type head A:</b> Male connector, M12, 4-pin, angled, D-coded</li> <li><b>Connection type head B:</b> Male connector, M12, 4-pin, angled, D-coded</li> <li><b>Signal type:</b> Ethernet, PROFINET</li> <li><b>Cable:</b> 5 m, 4-wire, PUR, halogen-free</li> <li><b>Description:</b> Ethernet, shielded, PROFINET</li> <li><b>Application:</b> Drag chain operation, Zones with oils and lubricants</li> </ul>	YN2D24-050P-N1N2D24	2127662
	<ul style="list-style-type: none"> <li><b>Connection type head A:</b> Male connector, RJ45, 4-pin, straight</li> <li><b>Connection type head B:</b> Male connector, M12, 4-pin, angled, D-coded</li> <li><b>Signal type:</b> Ethernet, PROFINET</li> <li><b>Cable:</b> 30 m, 4-wire, CAT5, CAT5e, PVC</li> <li><b>Description:</b> Ethernet, shielded, PROFINET</li> </ul>	SSL-2J04-F30MZ	6059450
	<ul style="list-style-type: none"> <li><b>Connection type head A:</b> Female connector, M12, 4-pin, D-coded</li> <li><b>Connection type head B:</b> Female connector, RJ45, 8-pin</li> <li><b>Signal type:</b> Ethernet</li> <li><b>Cable:</b> CAT5, CAT5e</li> <li><b>Description:</b> Ethernet, shielded</li> <li><b>Note:</b> Cabinet through</li> </ul>	Feedthrough female connector Ethernet RJ45	6048180

## SICK AT A GLANCE

SICK is one of the leading manufacturers of intelligent sensors and sensor solutions for industrial applications. A unique range of products and services creates the perfect basis for controlling processes securely and efficiently, protecting individuals from accidents and preventing damage to the environment.

We have extensive experience in a wide range of industries and understand their processes and requirements. With intelligent sensors, we can deliver exactly what our customers need. In application centers in Europe, Asia and North America, system solutions are tested and optimized in accordance with customer specifications. All this makes us a reliable supplier and development partner.

Comprehensive services complete our offering: SICK LifeTime Services provide support throughout the machine life cycle and ensure safety and productivity.

For us, that is “Sensor Intelligence.”

## WORLDWIDE PRESENCE:

Contacts and other locations –[www.sick.com](http://www.sick.com)