



IME18-12NPOZCOSS40

IME

INDUCTIVE PROXIMITY SENSORS

SICK
Sensor Intelligence.



Ordering information

Type	part no.
IME18-12NPOZCOSS40	1145779

Included in delivery: BEF-MU-M18 (1)

Other models and accessories → www.sick.com/IME

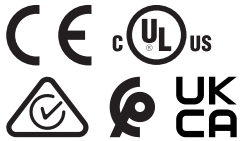

Detailed technical data

Features

Housing	Metric
Housing	Standard design
Thread size	M18 x 1
Diameter	Ø 18 mm
Sensing range S_n	12 mm
Safe sensing range S_a	9.72 mm
Installation type	Non-flush
Switching frequency	1,000 Hz
Connection type	Male connector M12, 4-pin
Switching output	PNP
Switching output detail	PNP
Output function	NC
Electrical wiring	DC 3-wire
Enclosure rating	IP67 ¹⁾
Special characteristic	Sensing face printed with "NC"
Items supplied	Mounting nut, brass, nickel-plated (2x)

¹⁾ According to EN 60529.

Mechanics/electronics

Supply voltage	10 V DC ... 30 V DC
Ripple	≤ 10 %

¹⁾ At I_B max.

²⁾ Supply voltage U_B and constant ambient temperature T_a.

³⁾ Of S_r.

Voltage drop	$\leq 2 \text{ V}^{1)}$
Time delay before availability	$\leq 100 \text{ ms}$
Hysteresis	5 % ... 15 %
Reproducibility	$\leq 2 \text{ \%}^{2)}$ 3)
Temperature drift (of S_r)	$\pm 10 \text{ \%}$
EMC	According to EN 60947-5-2
Continuous current I_a	$\leq 200 \text{ mA}$
No load current	$\leq 10 \text{ mA}$
Short-circuit protection	✓
Power-up pulse protection	✓
Shock and vibration resistance	30 g, 11 ms/10 Hz ... 55 Hz, 1 mm
Ambient operating temperature	-25 °C ... +75 °C
Housing material	Brass, nickel-plated
Sensing face material	Plastic, PA 66
Housing length	69 mm
Thread length	42 mm
Tightening torque, max.	$\leq 40 \text{ Nm}$
UL File No.	NRKH.E181493

1) At I_a max.

2) Supply voltage U_B and constant ambient temperature T_a .

3) Of S_r .

Safety-related parameters

MTTF_D	1,735 years
DC_{avg}	0 %

Reduction factors

Note	The values are reference values which may vary
St37 steel (Fe)	1
Stainless steel (V2A, 304)	Approx. 0.8
Aluminum (Al)	Approx. 0.45
Copper (Cu)	Approx. 0.4
Brass (Br)	Approx. 0.4

Installation note

Remark	Associated graphic see "Installation"
A	18 mm
B	36 mm
C	18 mm
D	36 mm
E	24 mm
F	96 mm

Certificates

EU declaration of conformity	✓
UK declaration of conformity	✓
ACMA declaration of conformity	✓
Moroccan declaration of conformity	✓
China RoHS	✓
cULus certificate	✓

Classifications

ECLASS 5.0	27270101
ECLASS 5.1.4	27270101
ECLASS 6.0	27270101
ECLASS 6.2	27270101
ECLASS 7.0	27270101
ECLASS 8.0	27270101
ECLASS 8.1	27270101
ECLASS 9.0	27270101
ECLASS 10.0	27270101
ECLASS 11.0	27270101
ECLASS 12.0	27274001
ETIM 5.0	EC002714
ETIM 6.0	EC002714
ETIM 7.0	EC002714
ETIM 8.0	EC002714
UNSPSC 16.0901	39122230

Installation note Non-flush installation

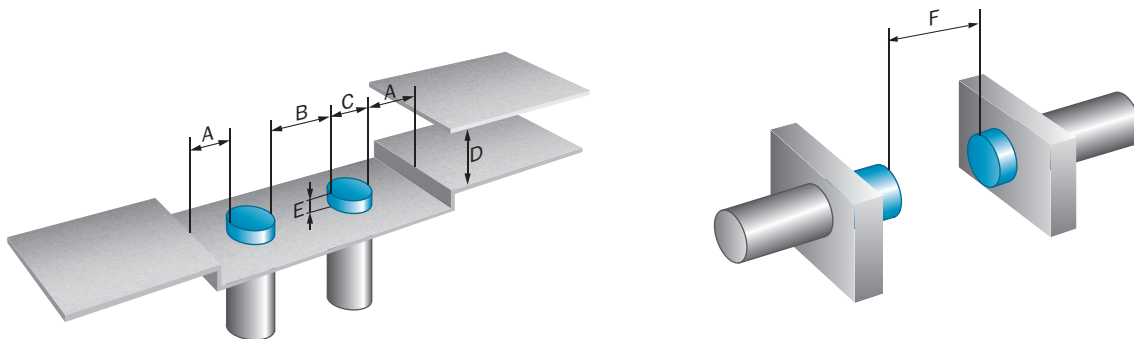

Connection type



Connection diagram Cd-008

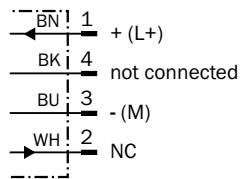

Dimensional drawing IME18 Standard, connector, non-flush

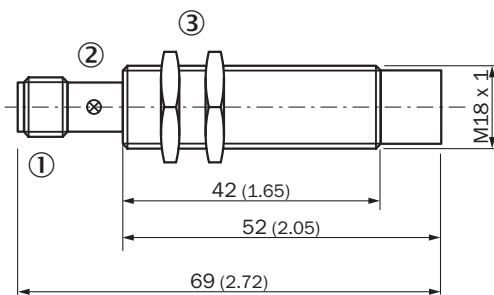





Dimensions in mm (inch)

- ① Connection
- ② Display LED
- ③ Fastening nuts (2x); width across 24, metal

Recommended accessories

Other models and accessories → www.sick.com/IME

	Brief description	Type	part no.
Mounting systems			
	<ul style="list-style-type: none"> Description: Clamping block for round sensors M18, with fixed stop Material: Plastic Details: Plastic (PA12), glass-fiber reinforced Items supplied: Mounting hardware included Suitable for: GR18, MH15V, V180-2, V18 	BEF-KHF-M18	2051482
	<ul style="list-style-type: none"> Description: Clamping block for round sensors M18, without fixed stop Material: Plastic Details: Plastic (PA12), glass-fiber reinforced Items supplied: Mounting hardware included Suitable for: GR18, MH15V, V180-2, V18, IME18, IMX18, IMA18, IMB18, IMI18 	BEF-KH-M18	2051481
	<ul style="list-style-type: none"> Description: Mounting plate for M18 sensors Material: Steel Details: Steel, zinc coated Items supplied: Without mounting hardware Suitable for: GR18, V180-2, V18, W15, Z1, Z2 	BEF-WG-M18	5321870
	<ul style="list-style-type: none"> Description: Mounting bracket for M18 sensors Material: Steel Details: Steel, zinc coated Items supplied: Without mounting hardware Suitable for: GR18, V180-2, V18, W15, Z1, Z2 	BEF-WN-M18	5308446
	<ul style="list-style-type: none"> Description: Mounting bracket for M18 sensors Material: Stainless steel Details: Stainless steel Items supplied: Without mounting hardware 	BEF-WN-M18N	5320947

	Brief description	Type	part no.
connectors and cables			
	<ul style="list-style-type: none"> Description: Unshielded Connection type head A: Female connector, M12, 4-pin, straight, A-coded Connection systems: Screw-type terminals Permitted cross-section: ≤ 0.75 mm² 	DOS-1204-G	6007302
	<ul style="list-style-type: none"> Description: Unshielded Connection type head A: Female connector, M12, 4-pin, angled, A-coded Connection systems: Screw-type terminals Permitted cross-section: ≤ 0.75 mm² 	DOS-1204-W	6007303
	<ul style="list-style-type: none"> Description: Sensor/actuator cable, unshielded Connection type head A: Female connector, M12, 4-pin, straight Connection type head B: Flying leads Signal type: Sensor/actuator cable Cable: 5 m, 4-wire, PVC Connection systems: Flying leads Note: This product is generally resistant to chemical cleaning agents (see ECOLAB). Please do not use cleaning agents of any other Kind., Not resistant against lactic acid & hydrogen peroxide (H2O2) Application: Uncontaminated zones, Hygienic and washdown zones, Zones with chemicals 	DOL-1204-G05MNI	6052615
	<ul style="list-style-type: none"> Description: Sensor/actuator cable, unshielded Connection type head A: Female connector, M12, 4-pin, straight Connection type head B: Flying leads Signal type: Sensor/actuator cable Cable: 5 m, 4-wire, PP Connection systems: Flying leads Note: This product is generally resistant to chemical cleaning agents (see ECOLAB) and other chemical compounds such as H2O2 and CH2O2. Before permanent installation is carried out, the material's resistance to the cleaning agent being used must be checked., Resistant against lactic acid & hydrogen peroxide (H2O2) Application: Hygienic and washdown zones, Drag chain operation, Robot, cold bending resistant, seawater resistant 	DOL-1204-G05MRN	6058476
	<ul style="list-style-type: none"> Description: Sensor/actuator cable, unshielded Connection type head A: Female connector, M12, 4-pin, straight, A-coded Connection type head B: Flying leads Signal type: Sensor/actuator cable Cable: 5 m, 4-wire, PVC Application: Uncontaminated zones, Zones with chemicals 	YF2A14-050VB3XLEAX	2096235
	<ul style="list-style-type: none"> Description: Sensor/actuator cable, unshielded Connection type head A: Female connector, M12, 4-pin, straight, A-coded Connection type head B: Flying leads Signal type: Sensor/actuator cable Cable: 5 m, 4-wire, PUR, halogen-free Application: Drag chain operation, Zones with oils and lubricants, Robot, Drag chain operation 	YF2A14-050UB3XLEAX	2095608
	<ul style="list-style-type: none"> Description: Sensor/actuator cable, unshielded Connection type head A: Female connector, M12, 4-pin, angled, A-coded Connection type head B: Flying leads Signal type: Sensor/actuator cable Cable: 0.6 m, 4-wire, PVC Application: Uncontaminated zones, Zones with chemicals 	YG2A14-C60VB3XLEAX	2145709
	<ul style="list-style-type: none"> Description: Sensor/actuator cable, unshielded Connection type head A: Female connector, M12, 4-pin, angled, A-coded Connection type head B: Flying leads Signal type: Sensor/actuator cable Cable: 1 m, 4-wire, PVC Application: Uncontaminated zones, Zones with chemicals 	YG2A14-010VB3XLEAX	2145710
	<ul style="list-style-type: none"> Description: Sensor/actuator cable, unshielded Connection type head A: Female connector, M12, 4-pin, straight, A-coded Connection type head B: Flying leads Signal type: Sensor/actuator cable Cable: 0.6 m, 4-wire, PVC Application: Uncontaminated zones, Zones with chemicals 	YF2A14-C60VB3XLEAX	2145707
	<ul style="list-style-type: none"> Description: Sensor/actuator cable, unshielded Connection type head A: Female connector, M12, 4-pin, straight, A-coded Connection type head B: Flying leads Signal type: Sensor/actuator cable Cable: 1 m, 4-wire, PVC Application: Uncontaminated zones, Zones with chemicals 	YF2A14-010VB3XLEAX	2145708

SICK AT A GLANCE

SICK is one of the leading manufacturers of intelligent sensors and sensor solutions for industrial applications. A unique range of products and services creates the perfect basis for controlling processes securely and efficiently, protecting individuals from accidents and preventing damage to the environment.

We have extensive experience in a wide range of industries and understand their processes and requirements. With intelligent sensors, we can deliver exactly what our customers need. In application centers in Europe, Asia and North America, system solutions are tested and optimized in accordance with customer specifications. All this makes us a reliable supplier and development partner.

Comprehensive services complete our offering: SICK LifeTime Services provide support throughout the machine life cycle and ensure safety and productivity.

For us, that is “Sensor Intelligence.”

WORLDWIDE PRESENCE:

Contacts and other locations –www.sick.com