



CLV618-I2150

CLV61x

FIXED MOUNT BARCODE SCANNERS

SICK
Sensor Intelligence.



Ordering information

Type	part no.
CLV618-I2150	1142815

Other models and accessories → www.sick.com/CLV61x



Detailed technical data

Features

Version	Long Range
Connection type	IO-Link
Reading field	Side (105°)
Sensor type	Line scanner
Optical focus	Fixed focus
Light source	Light spot, laser, Visible, Red, 655 nm
Laser class	2, complies with 21 CFR 1040.10 except for the conformance according to "Laser Notice No. 56" from May 8, 2019 (EN 60825-1:2014+A11:2021, IEC 60825-1:2014)
Aperture angle	≤ 50°
Reading distance	44 mm ... 683 mm ¹⁾
Scanning frequency	400 Hz ... 1,000 Hz
Code resolution	0.35 mm ... 1 mm

¹⁾ For details see reading field diagram.

Mechanics/electronics

Connection type	1 x IO-Link and POWER™ connection, 5-pin M12 male connector, A-coded 1 x "Sensor 1" connection, 5-pin M12 female connector, A-coded 1 x Micro USB female connector, type B
Supply voltage	18 V DC ... 30 V DC
Power consumption	3.2 W
Housing material	Aluminum die cast
Housing color	Light blue (RAL 5012)
Window material	Glass
Enclosure rating	IP65 (EN 60529:1991 + A1:2002 + A2:2013 + A3:2016)
Protection class	III (EN 60950-1/EN 62368-1)
Weight	260 g

¹⁾ At 25 °C.

Dimensions (L x W x H)	80 mm x 96 mm x 38 mm
MTBF	100,000 h
MTTF	40,000 h (Laser diode) ¹⁾

¹⁾ At 25 °C.

Performance

Readable code structures	1D codes
Bar code types	All current code types, Code 39, Code 128, Code 93, Codabar, UPC / GTIN / EAN, Interleaved 2 of 5
Code printing process	Label (printed codes)
Print ratio	2:1 ... 3:1
No. of codes per scan	1
No. of codes per reading interval	1
No. of characters per reading interval	31
No. of multiple readings	1 ... 99

Interfaces

IO-Link	Function	✓ , V1.1
	Data transmission rate	COM3 (230,4 kBaud)
USB	Function	✓
		Service interface
Digital inputs		2 (1 x "Sensor 1", 1 x via IO-Link Ctrl bits)
Digital outputs		1 (Via IO-Link process data output (ctrl. bits))
Reading pulse		IO-Link (default), Free (auto cycle), Digital input for local read cycle sensor
Optical indicators		2 LEDs
Configuration software		SOPAS ET

Ambient data

Electromagnetic compatibility (EMC)	EN 61000-6-4: 2019 / EN 61000-6-2: 2019
Vibration resistance	EN 60068-2-6:2008-02
Shock resistance	EN 60068-2-27:2009-05
Ambient operating temperature	0 °C ... +40 °C
Storage temperature	-20 °C ... +70 °C
Permissible relative humidity	90 %, Non-condensing
Ambient light immunity	2,000 lx, on barcode
Bar code print contrast (PCS)	≥ 60 %

General notes

Items supplied	Single scanner
-----------------------	----------------

Classifications

ECLASS 5.0	27280102
ECLASS 5.1.4	27280102
ECLASS 6.0	27280102

ECLASS 6.2	27280102
ECLASS 7.0	27280102
ECLASS 8.0	27280102
ECLASS 8.1	27280102
ECLASS 9.0	27280102
ECLASS 10.0	27280102
ECLASS 11.0	27280102
ECLASS 12.0	27280102
ETIM 5.0	EC002550
ETIM 6.0	EC002550
ETIM 7.0	EC002550
ETIM 8.0	EC002550
UNSPSC 16.0901	43211701

Certificates

EU declaration of conformity	✓
UK declaration of conformity	✓
ACMA declaration of conformity	✓
China RoHS	✓
cULus certificate	✓
IO-Link certificate	✓
Laser safety (IEC 60825-1) declaration of manufacturer	✓
Information according to Art. 3 of Data Act (Regulation EU 2023/2854)	✓

Dimensional drawing

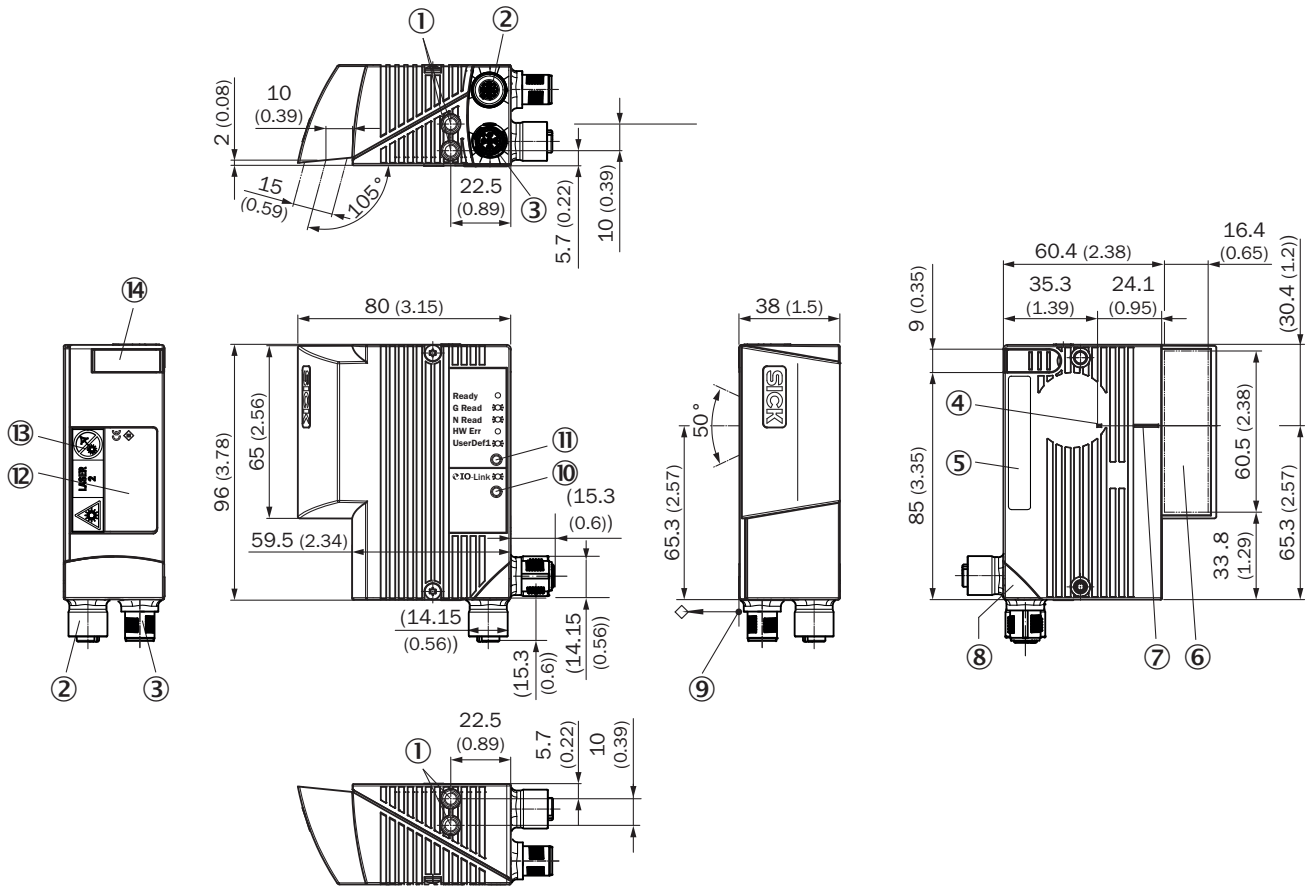

Dimensions in mm (inch)



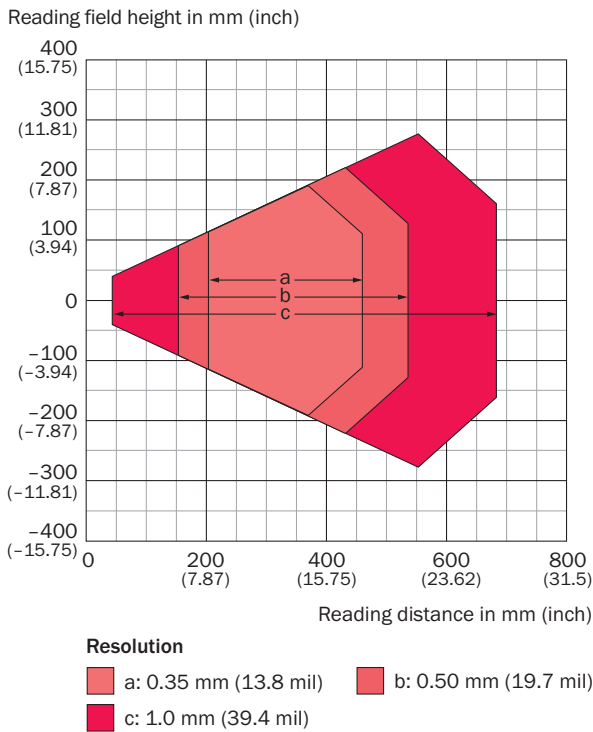

- ① blind hole thread M5, 5 mm deep (2 x), for mounting
- ② “Sensor 1” connection, female connector, M12, 5-pin, A-coded
- ③ “IO-Link” connection, male connector, M12, 5-pin, A-coded
- ④ internal impact point: rotation point of the variable direction laser beam
- ⑤ Additional plate for type label
- ⑥ Viewing window, side orientation
- ⑦ central position of the deflected laser beam in the V-shaped aperture angle
- ⑧ swivel connector unit (max 180° rotation angle from end position to end position)
- ⑨ reference point for reading distance (from housing edge to object)
- ⑩ “IO-Link” status display (RGB LED)
- ⑪ “Sensor” status display (RGB LED), with signal color assignment for events
- ⑫ type label
- ⑬ laser warning label
- ⑭ Cover for “USB” port (female connector, 5-pin, Micro-B type). The interface can only be used by SICK Service.



Reading field diagram



Recommended accessories

Other models and accessories → www.sick.com/CLV61x

	Brief description	Type	part no.
Mounting systems			
	<ul style="list-style-type: none"> • Description: Hanger-shaped mounting bracket • Items supplied: Mounting hardware included 	Mounting bracket	2042800
connectors and cables			
	<ul style="list-style-type: none"> • Connection type head A: Female connector, M12, 5-pin, straight, A-coded • Connection type head B: Male connector, M12, 5-pin, straight, A-coded • Signal type: Sensor/actuator cable • Cable: 2 m, 5-wire, PUR, halogen-free • Description: Sensor/actuator cable, unshielded • Application: Drag chain operation, Zones with oils and lubricants, Robot, Drag chain operation 	YF2A15-020UB5M2A15	2096009
	<ul style="list-style-type: none"> • Connection type head A: Female connector, M8, 4-pin, straight, A-coded • Connection type head B: Male connector, M12, 4-pin, straight, A-coded • Signal type: Sensor/actuator cable • Cable: 0.6 m, 4-wire, PUR, halogen-free • Description: Sensor/actuator cable, unshielded • Application: Drag chain operation, Zones with oils and lubricants, Robot, Drag chain operation 	YF8U14-C60UA3M2A14	2096135
	<ul style="list-style-type: none"> • Connection type head A: Female connector, M8, 4-pin, straight, A-coded • Connection type head B: Male connector, M12, 4-pin, straight, A-coded • Signal type: Sensor/actuator cable • Cable: 1 m, 4-wire, PUR, halogen-free • Description: Sensor/actuator cable, unshielded • Application: Drag chain operation, Zones with oils and lubricants, Robot, Drag chain operation 	YF8U14-010UA3M2A14	2145835

	Brief description	Type	part no.
network devices			
		IOLA2US-01101 (SiLink2 Master)	1061790
Photoelectric sensors			
	<ul style="list-style-type: none"> • Sensing range max.: 5 mm ... 110 mm • Functional principle: Photoelectric proximity sensor • Connection type: Male connector M8, 4-pin • Type of light: Visible red light • Adjustment: Potentiometer • Housing: Rectangular 	GTE6-P4201S57	1075634

SICK AT A GLANCE

SICK is one of the leading manufacturers of intelligent sensors and sensor solutions for industrial applications. A unique range of products and services creates the perfect basis for controlling processes securely and efficiently, protecting individuals from accidents and preventing damage to the environment.

We have extensive experience in a wide range of industries and understand their processes and requirements. With intelligent sensors, we can deliver exactly what our customers need. In application centers in Europe, Asia and North America, system solutions are tested and optimized in accordance with customer specifications. All this makes us a reliable supplier and development partner.

Comprehensive services complete our offering: SICK LifeTime Services provide support throughout the machine life cycle and ensure safety and productivity.

For us, that is “Sensor Intelligence.”

WORLDWIDE PRESENCE:

Contacts and other locations –www.sick.com