

SICK.COM

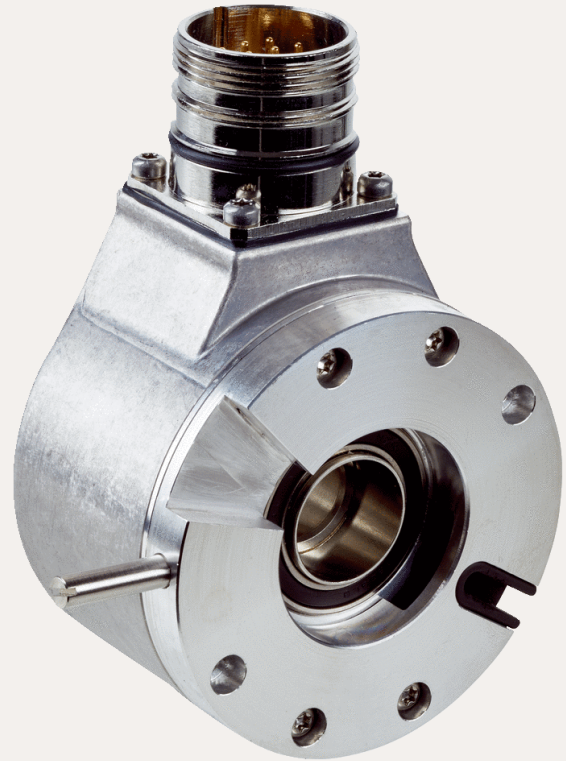

DATA SHEET

DBS60E-REFAC0050

DBS60
Incremental encoders

SICK Sensor Intelligence

INCREMENTAL ENCODERS

DBS60E-
REFAC0050

ORDERING INFORMATION

Type	part no.
DBS60E-REFAC0050	1142130

Further device versions and accessories at www.sick.com/DBS60



Illustration may differ

DETAILED TECHNICAL DATA

SAFETY-RELATED PARAMETERS

MTTF _D (mean time to dangerous failure)	500 years (EN ISO 13849-1) ¹⁾
--	--

¹⁾ This product is a standard product and does not constitute a safety component as defined in the Machinery Directive. Calculation based on nominal load of components, average ambient temperature 40°C, frequency of use 8760 h/a. All electronic failures are considered hazardous. For more information, see document no. 8015532.

PERFORMANCE

Pulses per revolution	50
Measuring step	≤ 90°, electric/pulses per revolution
Measuring step deviation	± 18° / pulses per revolution
Error limits	Measuring step deviation x 3
Duty cycle	≤ 0.5 ± 5 %

INTERFACES

Communication interface	Incremental
Communication Interface detail	TTL / HTL / HTL ¹⁾
Number of signal channels	6-channel
Initialization time	< 5 ms ²⁾

¹⁾ Output level depends on the supply voltage.

²⁾ Valid signals can be read once this time has elapsed.

³⁾ Up to 450 kHz on request.

Output frequency	+ 300 kHz ³⁾
Load current	≤ 30 mA, per channel
Power consumption	≤ 0.5 W (without load)

¹⁾ Output level depends on the supply voltage.

²⁾ Valid signals can be read once this time has elapsed.

³⁾ Up to 450 kHz on request.

ELECTRONICS

Connection type	Male connector, M23, 12-pin, radial
Supply voltage	4.5 ... 30 V
Reference signal, number	1
Reference signal, position	90°, electric, logically gated with A and B
Reverse polarity protection	✓
Short-circuit protection of the outputs	✓ ¹⁾

¹⁾ Short-circuit opposite to another channel, US or GND permissible for maximum 30 s.

MECHANICS

Mechanical design	Through hollow shaft
Shaft diameter	12 mm Rear clamping
Flange type / stator coupling	Axial and radial register pin mounting, for 4 mm register pin
Weight	+ 0.25 kg ¹⁾
Shaft material	Stainless steel
Flange material	Aluminum
Housing material	Aluminum
Start up torque	+ 0.5 Ncm (+20 °C)
Operating torque	0.4 Ncm (+20 °C)
Permissible movement static	± 0.3 mm (radial) ± 0.5 mm (axial) ²⁾
Permissible movement dynamic	± 0.1 mm (radial) ± 0.2 mm (axial) ²⁾
Operating speed	6,000 min ⁻¹ ³⁾
Maximum operating speed	9,000 min ⁻¹ ⁴⁾
Moment of inertia of the rotor	50 gcm ²
Bearing lifetime	3.6 x 10 ⁹ revolutions
Angular acceleration	≤ 500,000 rad/s ²

¹⁾ Based on encoder with male connector or cable with male connector.

²⁾ Not applicable for stator coupling type C and K.

³⁾ Allow for self-heating of 2.6 K per 1,000 rpm when designing the operating temperature range.

⁴⁾ Maximum speed which does not cause mechanical damage to the encoder. Impact on the service life and signal quality is possible. Please note the maximum output frequency.

AMBIENT DATA

EMC	According to EN 61000-6-2 and EN 61000-6-3
Enclosure rating	IP65, housing side (IEC 60529) ¹⁾ IP65, shaft side (IEC 60529)

¹⁾ With mating connector fitted.

²⁾ These values relate to all mechanical versions including recommended accessories unless otherwise noted.

INCREMENTAL ENCODERS - DBS60E-REFAC0050

Permissible relative humidity	90 % (Condensation not permitted)
Operating temperature range	-30 °C ... +100 °C, at maximum 3,000 pulses per revolution ²⁾
Storage temperature range	-40 °C ... +100 °C, without package
Resistance to shocks	250 g, 3 ms (EN 60068-2-27)
Resistance to vibration	30 g, 10 Hz ... 2,000 Hz (EN 60068-2-6)

¹⁾ With mating connector fitted.

²⁾ These values relate to all mechanical versions including recommended accessories unless otherwise noted.

CERTIFICATES

EU declaration of conformity	✓
UK declaration of conformity	✓
ACMA declaration of conformity	✓
China RoHS	✓
cRUus certificate	✓
Information according to Art. 3 of Data Act (Regulation EU 2023/2854)	✓

DIMENSIONAL DRAWING

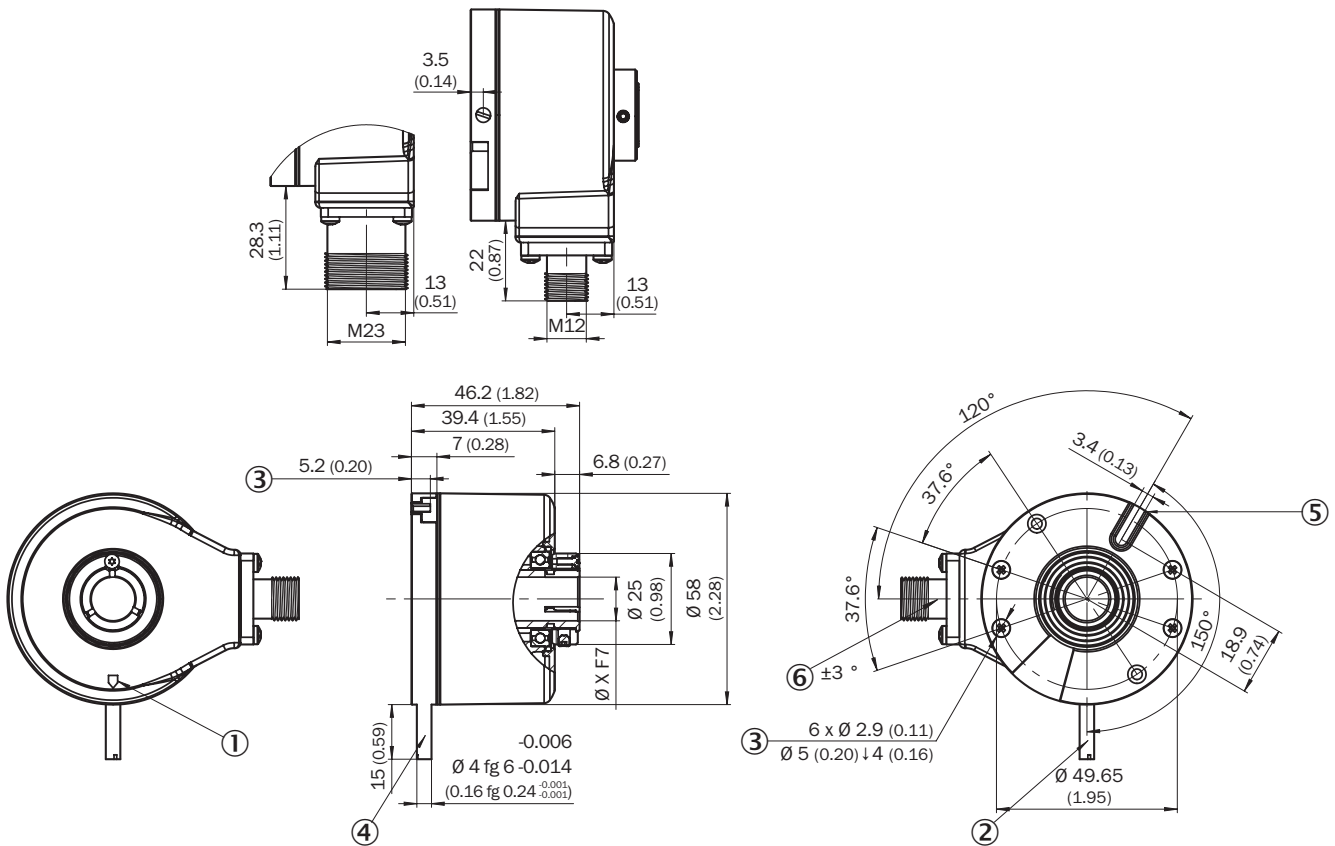

Dimensions in mm (inch)

XF7 values see shaft diameter table for through hollow shaft, clamping at the back

- ① Zero pulse mark on housing
- ② register pin is the zero pulse mark
- ③ depth
- ④ register pin can be removed
- ⑤ rubber insert, material: NBR
- ⑥ male connector tolerance in relation to hole pattern

Type	Through hollow shaft with rear clamping	Shaft diameter XF7
DBS60x-RAxxxxxxx		6 mm
DBS60x-R1xxxxxxx		
DBS60x-RBxxxxxxx		8 mm
DBS60x-R2xxxxxxx		
DBS60x-RCxxxxxxx		3/8"
DBS60x-R3xxxxxxx		
DBS60x-RDxxxxxxx		10 mm
DBS60x-R4xxxxxxx		
DBS60x-RExxxxxxx		12 mm
DBS60x-R5xxxxxxx		
DBS60x-RFxxxxxxx		1/2"
DBS60x-R6xxxxxxx		
DBS60x-RGxxxxxxx		14 mm
DBS60x-R7xxxxxxx		
DBS60x-RHxxxxxxx		15 mm
DBS60x-R8xxxxxxx		
DBS60x-RJxxxxxxx		5/8"

ATTACHMENT SPECIFICATIONS THROUGH HOLLOW SHAFT WITH REAR CLAMPING

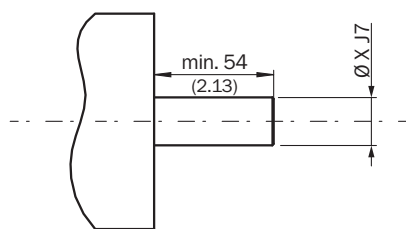

customer side

Type	Through hollow shaft with rear clamping	Shaft diameter xj7
DBS60x-RAxxxxxxx		6 mm
DBS60x-R1xxxxxxx		
DBS60x-RBxxxxxxx		8 mm
DBS60x-R2xxxxxxx		
DBS60x-RCxxxxxxx		3/8"
DBS60x-R3xxxxxxx		
DBS60x-RDxxxxxxx		10 mm
DBS60x-R4xxxxxxx		
DBS60x-RExxxxxxx		12 mm
DBS60x-R5xxxxxxx		
DBS60x-RFxxxxxxx		1/2"
DBS60x-R6xxxxxxx		
DBS60x-RGxxxxxxx		14 mm
DBS60x-R7xxxxxxx		
DBS60x-RHxxxxxxx		15 mm
DBS60x-R8xxxxxxx		
DBS60x-RJxxxxxxx		5/8"
	-	

PIN ASSIGNMENT

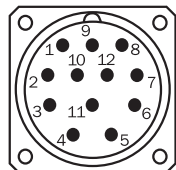

view of M23 male device connector on cable / housing

Wire colors (cable connection)	Male connector M12, 8-pin	Male connector M23, 12-pin	TTL/HTL 6-channel signal	Explanation
Brown	1	6	A-	Signal wire
White	2	5	A	Signal wire
Black	3	1	B-	Signal wire
Pink	4	8	B	Signal wire
Yellow	5	4	Z-	Signal wire
Purple	6	3	Z	Signal wire
Blue	7	10	GND	Ground connection
Red	8	12	+U _s	Supply voltage
-	-	9	Not assigned	Not assigned
-	-	2	Not assigned	Not assigned
-	-	11	Not assigned	Not assigned
-	-	7	Not assigned	Not assigned
Screen	Screen	Screen	Screen	Screen connected to encoder housing

DIAGRAMS

Pulses per revolution



DIAGRAMS SIGNAL OUTPUTS FOR ELECTRICAL INTERFACES TTL AND HTL

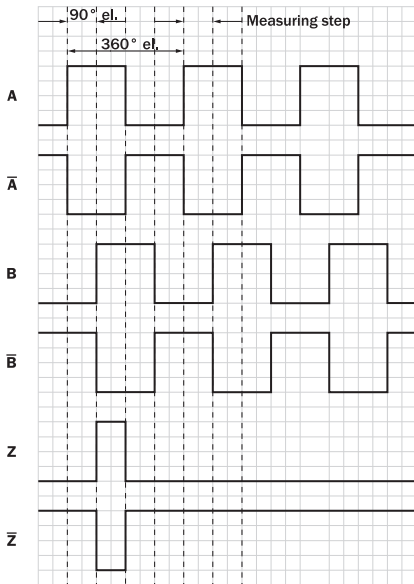

Cw with view on the encoder shaft in direction "A", compare dimensional drawing.

Supply voltage	Output
4,5 V ... 5,5 V	TTL
10 V ... 30 V	TTL
10 V ... 27 V	HTL
4,5 V ... 30 V	TTL/HTL universal
4,5 V ... 30 V	TTL

Further information as well as suitable accessories, example applications and downloads such as CAD dimensional models, operating instructions and software can be found at www.sick.com/1142130



SICK AG
WALDKIRCH
GERMANY
SICK.COM

SICK AT A GLANCE

SICK is a leading global technology company for intelligent sensors and integrated solutions in industrial automation. Our technologies set benchmarks, making your industrial processes more efficient, safer and more sustainable – both in logistics and manufacturing operations.

SICK combines sensor intelligence with industry expertise and certified consulting services. We provide the ideal foundation for scalable as well as tailor-made automation solutions and create added value along the entire value chain. Our close partnerships with our customers are more than just a promise: Together, we optimize productivity, improve quality, protect health and safety, and help build a sustainable future. All with empathy and trust.

Since 1946, we have been developing innovative technologies with passion and a pioneering spirit. With a global network in around 40 countries, SICK has a global presence and is always close by. The company's headquarters are located in Waldkirch near Freiburg, Germany. Our customers benefit from our understanding of both local and global requirements, which enables us to deliver tailor-made solutions

SICK
Sensor Intelligence