

SICK

EDS35-0KF0A0S06

EDS/EDM35

MOTOR FEEDBACK SYSTEMS

SICK
Sensor Intelligence.



Ordering information

Type	part no.
EDS35-0KF0A0S06	1141584

Illustration may differ

Other models and accessories → www.sick.com/EDS_EDM35

Detailed technical data

Features

Special device	✓
Specialty	Customized stator coupling, mounting compatible to EFS/EFM50
Standard reference device	EDS35-0KF0A024A, 1090732
Items supplied	M3 mounting screws for stator coupling not included with delivery.

Safety-related parameters

MTTF_D (mean time to dangerous failure)	145 years (EN ISO 13849) ¹⁾
--	--

¹⁾ This product is a standard product and does not constitute a safety component as defined in the Machinery Directive. Calculation based on nominal load of components, average ambient temperature 60 °C, frequency of use 8760 h/a. All electronic failures are considered hazardous. For more information, see document no. 8015532.

Performance

Position	
Resolution per revolution	24 bit
System accuracy	± 25 " ¹⁾
Signal noise (σ)	± 1 " ²⁾
Number of the absolute ascertainable revolutions	1
Available memory area	8,192 Byte
Measurement principle	Optical

¹⁾ In accordance with DIN ISO 1319-1, position of the upper and lower error limit depends on the installation situation, specified value refers to a symmetrical position, i.e. deviation in upper and lower direction is the same.

²⁾ Repeatability standard deviation in accordance with DIN 1319-1:1995.

Interfaces

Code sequence	Increasing, when turning the shaft For clockwise rotation, looking in direction "A" (see dimensional drawing)
Communication interface	HIPERFACE DSL®
Initialization time	≤ 500 ms ¹⁾

¹⁾ From reaching a permitted operating voltage.

²⁾ Without sensor tolerance; at -40 °C ... +160 °C: NTC +2K; PTC+3K (KTY84-130/PT1000). For additional conversion function of PT1000 to KTY84/130, see technical description.

Measurement external temperature resistance	32-bit value, without prefix (1 Ω) 0 ... 209.600 Ω ²⁾
--	--

¹⁾ From reaching a permitted operating voltage.

²⁾ Without sensor tolerance; at -40 °C ... +160 °C: NTC +2K; PTC+3K (KTY84-130/PT1000). For additional conversion function of PT1000 to KTY84/130, see technical description.

Electronics

Connection type	Male connector, 4-pin
Supply voltage	7 V ... 12 V
Warm-up time voltage ramp	Max. 180 ms ¹⁾
Current consumption	≤ 150 mA ²⁾

¹⁾ Duration of voltage ramp between 0 and 7.0 V.

²⁾ Current rating applies when using interface circuit suggestions as shown in HIPERFACE DSL® manual (8017595).

Mechanics

Shaft version	Tapered shaft
Flange type / stator coupling	Stator coupling
Dimensions	See dimensional drawing
Weight	≤ 100 g
Moment of inertia of the rotor	5 gcm ²
Operating speed	≤ 12,000 min ⁻¹
Angular acceleration	≤ 250,000 rad/s ²
Start up torque	≤ 0.4 Ncm, +20 °C
Permissible movement static	± 1 mm, axial ¹⁾
Permissible movement dynamic	± 0.1 mm, radial
Life of ball bearings	50,000 h at 6,000 min ⁻¹ (at a flange temperature of 70 °C)

¹⁾ Temperature expansion, mechanical attachment.

Ambient data

Operating temperature range	-40 °C ... +115 °C ¹⁾
Storage temperature range	-40 °C ... +125 °C, without package
Relative humidity/condensation	90 %, Condensation not permitted
Resistance to shocks	100 g, 6 ms (according to EN 60068-2-27)
Frequency range of resistance to vibrations	50 g, 10 Hz ... 2,000 Hz (EN 60068-2-6)
EMC	According to EN 61000-6-2, EN 61000-6-4 and IEC 61326-3 ²⁾
Enclosure rating	IP40, When cover is closed and mating connector is attached (IEC 60529-1)

¹⁾ Given typical thermal connection between motor flange and encoder stator coupling. The max. internal sensor temperature may not exceed 125 °C.

²⁾ According to the listed standards, EMC is guaranteed if the motor feedback system with mating plug inserted is connected to the central grounding point of the motor controller via a cable shield. If other shielding concepts are used, users must perform their own tests. Class A device.

Certificates

EU declaration of conformity	✓
UK declaration of conformity	✓
ACMA declaration of conformity	✓
Moroccan declaration of conformity	✓

China RoHS	✓
Information according to Art. 3 of Data Act (Regulation EU 2023/2854)	✓

Classifications

ECLASS 5.0	27270590
ECLASS 5.1.4	27270590
ECLASS 6.0	27270590
ECLASS 6.2	27270590
ECLASS 7.0	27270590
ECLASS 8.0	27270590
ECLASS 8.1	27270590
ECLASS 9.0	27270590
ECLASS 10.0	27273805
ECLASS 11.0	27273901
ECLASS 12.0	27273901
ETIM 5.0	EC001486
ETIM 6.0	EC001486
ETIM 7.0	EC001486
ETIM 8.0	EC001486
UNSPSC 16.0901	41112113

PIN	Signal	Explanation
1	-	Not connected - no function
2	+U _S /DSL+	Supply 7 V ... 12 V
3	GND/DSL-	Ground connection
4	-	Not connected - no function

Recommended outer diameter of set of stranded wires: 2.8 mm ±0.3 mm

Recommended mating connector: JST (GHR-04V-S)

Diagrams

Typical inrush current (A)

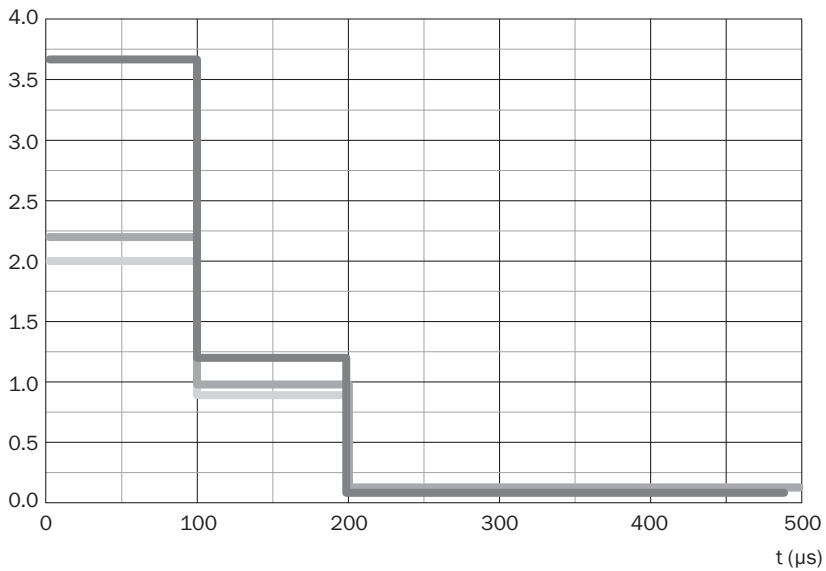

— 7 V Us
 — 8 V Us
 — 12 V Us

Operation note Overview of warnings and fault indications

Error type	Error register	Error bit	Description
Position (incremental)	40h	0	A Protocol reset was executed
	40h	1	Acceleration overflow, invalid position
	40h	2	Test running
	40h	4	Internal error in angular tracking, invalid position
	40h	5	Internal error in vector length, invalid position
	40h	6	Internal error in position counter, invalid position
	40h	7	Internal error in position synchronization, invalid position
Position (absolute)	41h	0	Error in absolute position in a rotation
	41h	1	Multiturn amplitude error
	41h	2	Multiturn sync error
	41h	3	Multiturn vector length error
	41h	4	Position cross check error
Initialization	42h	0	Switch-on self-test undertaken (only safety versions)
	42h	1	Warning safety parameter: error could be rectified (only safety variants)
	42h	2	Error safety parameter: error cannot be rectified (only safety variants)
	42h	3	Standard parameter error
	42h	4	Internal communications error 1
	42h	5	Internal communications error 2
	42h	6	Internal general error
Checking	43h	0	Critical temperature
	43h	1	Critical LED current
	43h	2	Critical supply voltage
	43h	3	Critical speed
	43h	5	Counter overflow
	43h	6	Internal monitoring error
Access to resources	44h	0	Invalid argument given during resource access procedure
	44h	1	Resource access refused due to incorrect access level
	44h	2	Internal error during resource access
	44h	3	Error when accessing a user file
User-defined warnings	47h	0	User-defined warning 0
	47h	1	User-defined warning 1
	47h	2	User-defined warning 2
	47h	3	User-defined warning 3

Operation note Supported resources for HIPERFACE DSL®



RID	Name	time overrun [ms]	Description
0x000	ROOT	75	Top node of resource tree (all nodes reachable from here)
0x001	IDENT	75	Node with pointers to all identification resources
0x002	MONITOR	75	Node with pointers to all monitoring resources
0x003	ADMIN	75	Node with pointers to all administration resources
0x004	COUNTER	75	Node with pointers to all counter resources
0x005	DATA	75	Node with pointers to all user file resources
0x006	SENSHUB	75	Node with pointers to all SensorHub resources
0x080	ENCTYPE	120	Base functionality of encoder
0x081	RESOLUTN	120	Number of steps per turn
0x082	RANGE	120	Number of encoded revolutions
0x083	TYPECODE	120	Type name of encoder
0x084	SERIALNO	120	Serial no of encoder
0x085	FWREVNO	120	Firmware and hardware revision of encoder
0x086	FWDATE	120	Firmware date of encoder
0x087	EESIZE	120	Total amount of memory for user files
0x089	VPOS2RES	120	Number of steps per turn (DSL Safe Position 2)
0x0c0	TEMPRNG	90	Min and max allowed ambient temperature of encoder
0x0c1	TEMPRTUR	70	Actual ambient temperature of encoder
0x0c2	LEDRANGE	90	Min and max allowed LED current of encoder
0x0c3	LEDCURR	70	Actual LED current of encoder
0x0c4	SUPRANGE	90	Min and max allowed supply voltage of encoder
0x0c5	SUPVOLT	70	Actual supply voltage of encoder
0x0c6	SPEEDRNG	90	Max allowed shaft speed of encoder
0x0c7	SPEED	70	Actual shaft speed of encoder
0x0c8	ACCRANGE	90	Max allowed shaft acceleration of encoder
0x0cb	LIFETIME	70	Operating time and total shaft turns of encoder. For safety variants also remaining mission time is indicated.
0x0cc	ERRORLOG	100	Stored error messages of encoder
0x0cd	HISTOGRM	70	Usage history of encoder in histogram form
0x0d5	ERRLOGFI	100	Filters the error log entries
0x100	RESET	240	Reset or shutdown of encoder
0x101	SETPOS	200	Set encoder position to arbitrary preset value. Offset of position can be read back.
0x104	SETACCES	70	Set or read back access level
0x105	CHNGEKEY	90	Change password for access level
0x107	UWARNING	90	Set or read back user-defined warning boundaries
0x108	FACRESET	1100	Reset user settings of encoder to factory defaults
0x109	ENCIDENT	90	Set or read back user-defined encoder index (for multi-axis systems)
0x10a	POSFLT	90	Set or read back position filter settings
0x10f	SHUBTOUT	90	Access to sHub time-out settings
0x111	ENCINDEX	90	Set or read back user-defined encoder index (for multi-axis systems)
0x11d	FEATURES	90	Set or read back encoder features
0x11f	BOOTLOAD	200	Bootloader access for end user (planned)
0x120	READCNT	90	Read user counter value
0x121	INCCOUNT	90	Increment user counter value
0x122	RESETCNT	90	Reset user counter value
0x130	LOADFILE	900	Load user file
0x131	RWFILE	260	Read from or write to user file
0x132	FILESTAT	70	Read status of user file
0x133	MAKEFILE	1100	Create, change or delete user file
0x134	DIR	150	Read directory of accessible user files
0x136	FILEBACK	90	Set or read back status of user file backup
0x200	ACCESSIO	70	Access to simple I/Os connected directly to encoder
0x201	MANAGEIO	180	Manage simple I/Os
0x202	IDENTIO	70	Identify simple I/Os
0x210	SH_RESET	180	Reset of sHub
0x218	SH_FACSE	255	Reset user settings of sHub to factory defaults
0x21d	SH_FEATS	90	Set or read back encoder features
0x280	SH_TYPE	180	Base functionality of sHub
0x283	SH_TYPCO	180	Type name of sHub
0x284	SH_SERNO	180	Serial no of sHub
0x285	SH_FWREV	70	Firmware and hardware revision of sHub
0x286	SH_FWDAT	70	Firmware date of sHub
0x2c0	SH_TEMP	180	Min and max allowed ambient temperature of sHub
0x2c4	SH_SUPR	180	Min and max allowed supply voltage of sHub
0x2cb	SH_LIFET	70	Operating time of sHub
0x2cc	SH_ERRLG	220	Stored error messages of sHub

Operation note Supported access levels

Access level	User	Standard access key
0	Execute (default setting)	- (no key required)
1	Operator	1111 (31 31 31 31h)
2	Maintenance	2222 (32 32 32 32h)
3	Authorized client	3333 (33 33 33 33h)
4	User service	4444 (34 34 34 34h)

Recommended accessories

Other models and accessories → www.sick.com/EDS_EDM35

	Brief description	Type	part no.
Mounting systems			
	<ul style="list-style-type: none"> Description: Screws with Precote 85-8 coating; M4*48 (4093779) Packing unit: 500 pieces 	BEF-MK-S09	2103244
	<ul style="list-style-type: none"> Description: Screws with Precote 85-8 coating; M4*48 (4093779) Packing unit: 100 pieces 	BEF-MK-S10	2103272
	<ul style="list-style-type: none"> Description: Screws with Precote 85-8 coating; M4*48 (4093779) Packing unit: 10 pieces 	BEF-MK-S11	2103274
connectors and cables			
	<ul style="list-style-type: none"> Description: HIPERFACE DSL[®], unshielded Connection type head A: Female connector, stranded wire, 4-pin, straight Connection type head B: Flying leads Signal type: HIPERFACE DSL[®] Cable: 0.2 m, 2-wire 	DOL-0B02-G0M2XC2	2079920
	<ul style="list-style-type: none"> Description: HIPERFACE DSL[®], twisted, shielded Connection type head A: Female connector, stranded wire, 4-pin, straight Connection type head B: Flying leads Signal type: HIPERFACE DSL[®] Cable: 0.36 m, 2-wire 	DOL-0B02-G0M3AC2	2108944

SICK AT A GLANCE

SICK is one of the leading manufacturers of intelligent sensors and sensor solutions for industrial applications. A unique range of products and services creates the perfect basis for controlling processes securely and efficiently, protecting individuals from accidents and preventing damage to the environment.

We have extensive experience in a wide range of industries and understand their processes and requirements. With intelligent sensors, we can deliver exactly what our customers need. In application centers in Europe, Asia and North America, system solutions are tested and optimized in accordance with customer specifications. All this makes us a reliable supplier and development partner.

Comprehensive services complete our offering: SICK LifeTime Services provide support throughout the machine life cycle and ensure safety and productivity.

For us, that is “Sensor Intelligence.”

WORLDWIDE PRESENCE:

Contacts and other locations –www.sick.com