



# GTE20G-1IRC117GZZZ

G20

PHOTOELECTRIC SENSORS

**SICK**  
Sensor Intelligence.

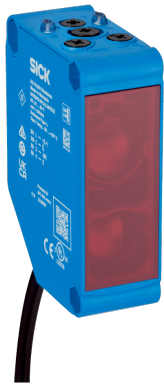
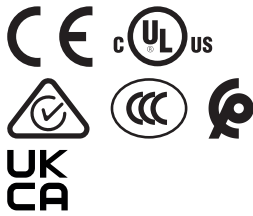

Illustration may differ



### Ordering information

Type	part no.
GTE20G-1IRC117GZZZ	1140255

Other models and accessories → [www.sick.com/G20](http://www.sick.com/G20)

### Detailed technical data

#### Features

<b>Functional principle</b>	Photoelectric proximity sensor
<b>Functional principle detail</b>	Energetic
<b>Sensing range</b>	
Sensing range min.	0.02 m
Sensing range max.	2 m
Reference object	Object with 90% remission factor (complies with standard white according to DIN 5033)
<b>Emitted beam</b>	
Light source	LED
Type of light	Visible red light
Shape of light spot	Rectangular
Light spot size (distance)	Ø 28 mm (500 mm)
Maximum dispersion of the emitted beam around the standardized transmission axis (squint angle)	< +/- 1.5° (at Ta = +23 °C)
<b>Key LED figures</b>	
Normative reference	EN 62471:2008-09   IEC 62471:2006, modified
LED risk group marking	Free group
Wave length	630 nm
Average service life	100,000 h at Ta = +25 °C
<b>Adjustment</b>	
Potentiometer	For sensitivity adjustment, 270°
<b>Display</b>	
LED green	Operating indicator

LED yellow	Static on: power on
	Status of received light beam
	Static on: object present Static off: object not present

## Electronics

<b>Supply voltage <math>U_e</math></b>	24 V AC/DC ... 240 V AC/DC <sup>1)</sup>
<b>Ripple</b>	< 10 %
<b>Usage category</b>	DC-13 (according to EN 60947-1) AC-15 (according to EN 60947-1)
<b>Current consumption</b>	≤ 10 mA, Without load At 230 V AC/DC ≤ 45 mA, Without load At 24 V AC/DC
<b>Protection class</b>	II
<b>Digital output</b>	
Number	2 (Complementary)
Type	Relay, SPDT, electrically isolated <sup>2)</sup>
Switching mode	Light/dark switching
Output current $I_{max}$	4 A@250 V AC, 4 A@24 VDC, 0.11 A@250 V DC
	UL: 4 A@250 V AC, general use
	4 A @ 250 V AC, resistive (NO)
	3 A @ 250 V AC, resistive (NC)
	4 A @ 24 V DC, NO, general use
	3 A @ 24 V DC, NC, general use
	R300/B300 (NO contacts only)
Response time	≤ 15 ms
Switching frequency	10 Hz <sup>3)</sup>
Time functions	Deactivated (factory setting)
	Switch-on delay
	Off delay
	ON and OFF delay
Delay time	Adjustable via time delay selector switch, 0 ms ... 10,000 ms, 0 ms (factory setting)
<b>Pin/Wire assignment</b>	
BN	L/(+)
BU	N/(-)
WH	Relay COM
BK	Relay NO Relay output, light switching, object present → output HIGH
GY	Relay NC Relay output, dark switching, object present → output LOW

<sup>1)</sup> +- 10 %.

<sup>2)</sup> Valid only for devices manufactured before June 18, 2023 with a date code of 2324 or earlier. Suitable arc suppression with inductive or capacitive load. Relay contacts are separated from the supply voltage by a base insulation of 3.2 mm. Depending on the application, additional insulation may be required in the user wiring.

<sup>3)</sup> With light/dark ratio 1:1.

## Mechanics

<b>Housing</b>	Rectangular
<b>Dimensions (W x H x D)</b>	23.5 mm x 74.5 mm x 63 mm

<b>Connection</b>	Cable, 5-wire, 2 m
<b>Connection detail</b>	
Deep-freeze property	Do not bend below 0 °C
Conductor size	0.32 mm <sup>2</sup>
Cable diameter	Ø 5 mm
Length of cable (L)	2 m
<b>Material</b>	
Housing	Plastic, ABS
Front screen	Plastic, PMMA
Cable	Plastic, PVC
<b>Weight</b>	Approx. 209 g

### Ambient data

<b>Enclosure rating</b>	IP67 (EN 60529)
<b>Ambient operating temperature</b>	-30 °C ... +60 °C <sup>1)</sup>
<b>Ambient temperature, storage</b>	-40 °C ... +70 °C
<b>Typ. Ambient light immunity</b>	Sunlight: ≤ 20,000 lx
<b>Shock resistance</b>	30 g, 11 ms (3 positive and 3 negative shocks along X, Y, Z axes, 18 total shocks (EN60068-2-27))
<b>Vibration resistance</b>	10 Hz ... 1,000 Hz (Amplitude 1 mm, 3 x 30 min (EN60068-2-6))
<b>Air humidity</b>	35 % ... 95 %, relative humidity (no condensation)
<b>Electromagnetic compatibility (EMC)</b>	EN 60947-5-2, EN 61000-6-3
<b>UL File No.</b>	NRKH.E348498 & NRKH7.E348498

<sup>1)</sup> The max. ambient temperature is 50 °C (UL).

### Certificates

<b>EU declaration of conformity</b>	✓
<b>UK declaration of conformity</b>	✓
<b>ACMA declaration of conformity</b>	✓
<b>Moroccan declaration of conformity</b>	✓
<b>China RoHS</b>	✓
<b>CCC certificate</b>	✓
<b>cULus certificate</b>	✓
<b>Photobiological safety (IEC EN 62471)</b>	✓

### Classifications

<b>ECLASS 5.0</b>	27270904
<b>ECLASS 5.1.4</b>	27270904
<b>ECLASS 6.0</b>	27270904
<b>ECLASS 6.2</b>	27270904
<b>ECLASS 7.0</b>	27270904
<b>ECLASS 8.0</b>	27270904
<b>ECLASS 8.1</b>	27270904
<b>ECLASS 9.0</b>	27270904

<b>ECLASS 10.0</b>	27270904
<b>ECLASS 11.0</b>	27270904
<b>ECLASS 12.0</b>	27270903
<b>ETIM 5.0</b>	EC002719
<b>ETIM 6.0</b>	EC002719
<b>ETIM 7.0</b>	EC002719
<b>ETIM 8.0</b>	EC002719
<b>UNSPSC 16.0901</b>	39121528

display and adjustment elements

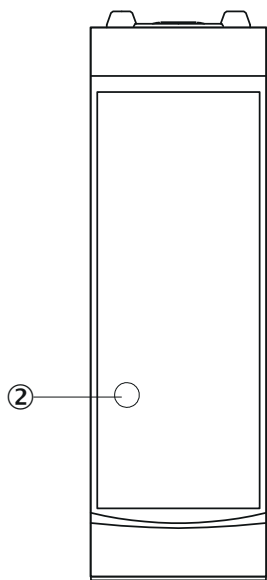

② LED yellow

display and adjustment elements

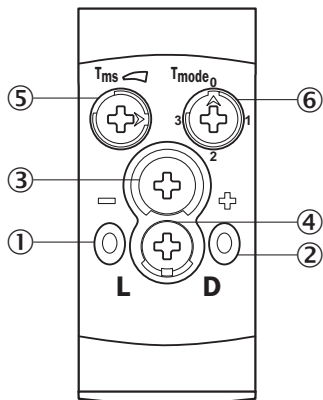

- ① LED green
- ② LED yellow
- ③ Potentiometer 1

- ④ operating mode switch
- ⑤ Potentiometer 2
- ⑥ Potentiometer 3

### Connection type Cable, 5-wire

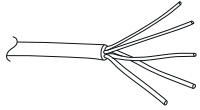

### Connection diagram Cd-163

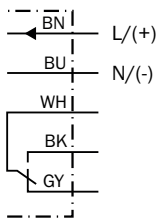

### Characteristic curve

Operating reserve

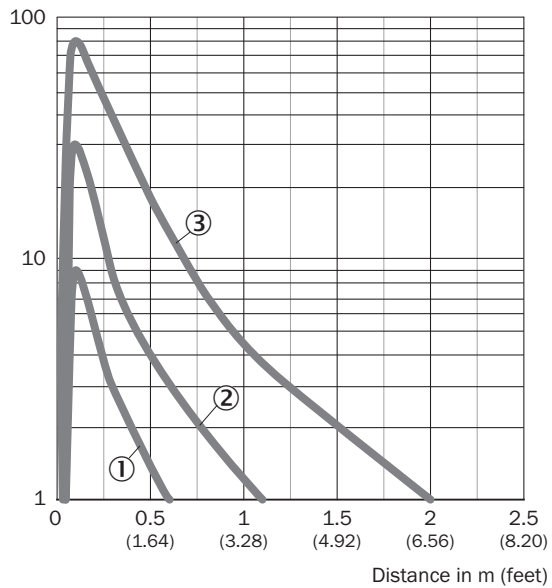

- ① Black object, 6% remission factor
- ② Gray object, 18% remission factor
- ③ White object, 90% remission factor

### Light spot size

Dimensions in mm (inch)

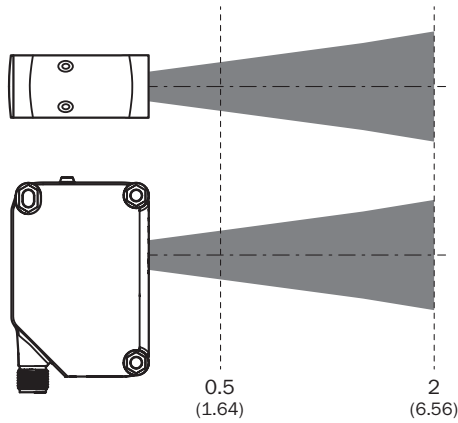
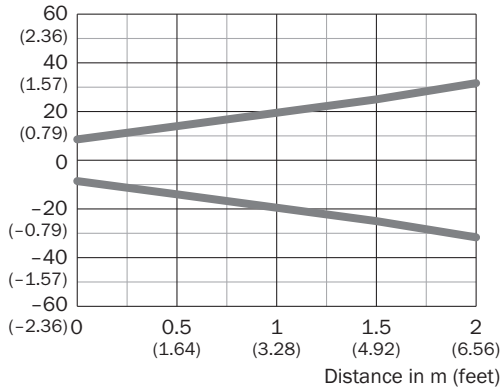

### Sensing range diagram

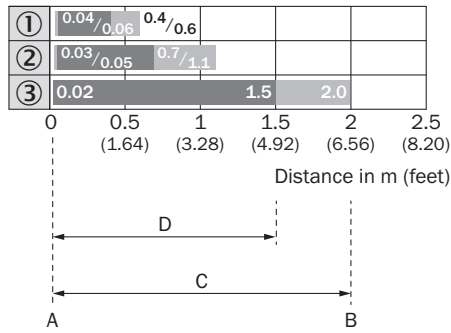

1	Black object, 6% remission factor
2	Gray object, 18% remission factor
3	White object, 90% remission factor
A	Sensing range min. in m
B	Sensing range max. in m
C	Maximum distance range from sensor to object
D	Recommended distance range from sensor to object



## SICK AT A GLANCE

SICK is one of the leading manufacturers of intelligent sensors and sensor solutions for industrial applications. A unique range of products and services creates the perfect basis for controlling processes securely and efficiently, protecting individuals from accidents and preventing damage to the environment.

We have extensive experience in a wide range of industries and understand their processes and requirements. With intelligent sensors, we can deliver exactly what our customers need. In application centers in Europe, Asia and North America, system solutions are tested and optimized in accordance with customer specifications. All this makes us a reliable supplier and development partner.

Comprehensive services complete our offering: SICK LifeTime Services provide support throughout the machine life cycle and ensure safety and productivity.

For us, that is “Sensor Intelligence.”

## WORLDWIDE PRESENCE:

Contacts and other locations –[www.sick.com](http://www.sick.com)