



LFP0430-A4NMB

LFP Cubic

LEVEL SENSORS

SICK
Sensor Intelligence.



Illustration may differ



Ordering information

Type	part no.
LFP0430-A4NMB	1139768

Other models and accessories → www.sick.com/LFP_Cubic

Detailed technical data

Features

Medium	Fluids
Measurement	Switch, Continuous
Design	Standard amplifier
Probe type	Rod probe
Probe length	430 mm
Process pressure	-1 bar ... 10 bar
Process temperature	-20 °C ... +100 °C

Performance

Accuracy of sensor element	± 5 mm ¹⁾
Reproducibility	≤ 2 mm
Resolution	< 2 mm
Response time	400 ms
Dielectricity constant	≥ 5 for rod probe / cable probe ≥ 1.8 with coaxial tube
Conductivity	No limitation
Maximum level change	≤ 500 mm/s
Deactivated area at process connection	25 mm ²⁾
Deactivated area at end of probe	≥ 10 mm ¹⁾
MTTF	194.3 years (EN ISO 13849-1)
Display	✓

¹⁾ With water under reference conditions.

²⁾ With parameterized container with water under reference conditions, otherwise 40 mm.

Electronics

Communication interface	IO-Link
Supply voltage	12 V DC ... 30 V DC ¹⁾
Power consumption	≤ 100 mA at 24 V DC without output load
Initialization time	≤ 5 s
Protection class	III
Connection type	Round connector M12 x 1, 5-pin
Output signal	1 x PNP + 1 x PNP/NPN + 4 mA ... 20 mA / 0 V ... 10 V
Output load	4 mA ... 20 mA < 350 Ohm at U _v > 12 V, 0 V ... 10 V > 750 Ohm at U _v 14 ≥ V
Hysteresis	≥ 2 mm ²⁾
Output current	< 100 mA
Inductive load	< 1 H
Capacitive load	100 nF
Enclosure rating	IP67 (EN 60529)
Temperature drift	< 0.1 mm/K
Lower signal level	3.8 mA ... 4 mA
Upper signal level	20 mA ... 20.5 mA
EMC	EN 61326-2-3, 2014/30/EU

¹⁾ All connections are polarity protected. All outputs are overload and short-circuit protected.

²⁾ Freely adjustable.

Mechanics

Wetted parts	Stainless steel 1.4404 / 316L PTFE FKM
Process connection	G 3/4 A
Housing material	Plastic PBT
Max. probe load	≤ 6 Nm

Ambient data

Ambient operating temperature	-20 °C ... +60 °C
Ambient temperature, storage	-40 °C ... +80 °C

Certificates

EU declaration of conformity	✓
UK declaration of conformity	✓
ACMA declaration of conformity	✓
Moroccan declaration of conformity	✓
China RoHS	✓
cULus certificate	✓
IO-Link certificate	✓
Information according to Art. 3 of Data Act (Regulation EU 2023/2854)	✓

Classifications

ECLASS 5.0	27200513
-------------------	----------

ECLASS 5.1.4	27200513
ECLASS 6.0	27200513
ECLASS 6.2	27200513
ECLASS 7.0	27200513
ECLASS 8.0	27200513
ECLASS 8.1	27200513
ECLASS 9.0	27200513
ECLASS 10.0	27200513
ECLASS 11.0	27200513
ECLASS 12.0	27200513
ETIM 5.0	EC001447
ETIM 6.0	EC001447
ETIM 7.0	EC001447
ETIM 8.0	EC001447
UNSPSC 16.0901	41113710

Dimensional drawing: rod probe



Dimensions in mm (inch)

- ① M: measuring range
- ② L: Probe length
- ③ IA: Inactive area at process connection 25 mm (0.98")
- ④ IAE: Inactive area at probe end 10 mm (0.39")

Connection type



- ① L⁺: Supply voltage, brown
- ② Q_A: Analog current-/voltage output, white
- ③ M: Ground, reference ground for current-/voltage output, blue
- ④ C/Q₁: Switching output 1, PNP/IO-Link-communication, black
- ⑤ Q₂: Switching output 2, PNP/NPN, grey

Instruction for installation



Mono rod probe mounted in metal tank

M = Measuring range
 X = Inactive area at probe end
 No measurement possible

Rope probe mounted in metal tank

Installation in nozzle:
 D ≥ DN 25 (1")
 Distance tank wall/tank bottom:
 A ≥ 50 mm (1.97")
 Distance to other tank fittings:
 ≥ 100mm (3.94")

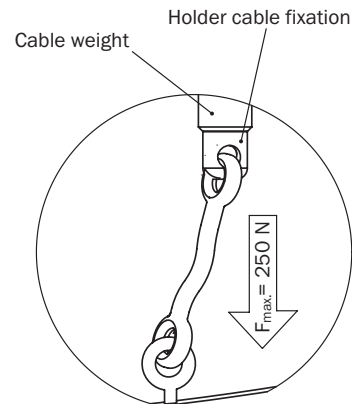

Instruction for installation Installation in a metal immersion tube or metal bypass



Instruction for installation Installation in a metal tank



Unit with mono probe mounted in metal tank

Installation in nozzle:

$D \geq \text{DN } 25 \text{ (1")}$

Distance tank wall/tank bottom:

$A \geq 50 \text{ mm (1.97")}$

$B \geq 10 \text{ mm (0.40")}$

Distance to other tank fittings

$\geq 100 \text{ mm (3.94")}$

Unit with coaxial tube for metal and non metal tank











$C =$ with a coaxial tube there are no minimum distances to the tank wall or to other tank fittings required

Recommended accessories

Other models and accessories → www.sick.com/LFP_Cubic

	Brief description	Type	part no.
Mounting systems			
	<ul style="list-style-type: none"> Description: Mounting bracket Material: Stainless steel Details: Stainless steel 1.4301 (AISI 304) Items supplied: Mounting hardware included 	BEF-FL-304LFP-HLDR	2077391
	<ul style="list-style-type: none"> Description: Spare probe for LFP Cubic, probe length 1000 mm, material 1.4404/316L, diameter 7 mm 	BEF-ER-SN1000-LFPC	2065700
	<ul style="list-style-type: none"> Description: Spare probe for LFP Cubic, probe length 2000 mm, material 1.4404/316L, diameter 7 mm 	BEF-ER-SN2000-LFPC	2065701
	<ul style="list-style-type: none"> Description: Process connection adapter G 3/4 to G1 	BEF-HA-G1BSP1-LFP1	2067603
	<ul style="list-style-type: none"> Description: Weld-in flange G 3/4" 	BEF-FL-GEWG34-LFP1	2082150

	Brief description	Type	part no.
device protection and care			
	<ul style="list-style-type: none"> Description: Coaxial tube for LFP with process connection G 3/4, process connection of coaxial tube G 3/4, material 1.4571/316TI, for probe length 1000 mm 	LFPCT-1000G1	2065702
	<ul style="list-style-type: none"> Description: Coaxial tube for LFP with process connection G 3/4, process connection of coaxial tube G 3/4, material 1.4571/316TI, for probe length 2000 mm 	LFPCT-2000G1	2065703
	<ul style="list-style-type: none"> Description: Coaxial tube for LFP with process connection G 3/4, process connection of coaxial tube G 3/4, material 1.4571/316TI, for probe length 1100 mm 	LFPCT-1100G1	2068148
	<ul style="list-style-type: none"> Description: Coaxial tube for LFP with process connection G 3/4, process connection of coaxial tube G 3/4, material 1.4571/316TI, for probe length 1200 mm 	LFPCT-1200G1	2068149
	<ul style="list-style-type: none"> Description: Coaxial tube for LFP with process connection G 3/4, process connection of coaxial tube G 3/4, material 1.4571/316TI, for probe length 1300 mm 	LFPCT-1300G1	2068150
	<ul style="list-style-type: none"> Description: Coaxial tube for LFP with process connection G 3/4, process connection of coaxial tube G 3/4, material 1.4571/316TI, for probe length 1400 mm 	LFPCT-1400G1	2068151
	<ul style="list-style-type: none"> Description: Coaxial tube for LFP with process connection G 3/4, process connection of coaxial tube G 3/4, material 1.4571/316TI, for probe length 1600 mm 	LFPCT-1600G1	2068153
	<ul style="list-style-type: none"> Description: Coaxial tube for LFP with process connection G 3/4, process connection of coaxial tube G 3/4, material 1.4571/316TI, for probe length 1700 mm 	LFPCT-1700G1	2068154
	<ul style="list-style-type: none"> Description: Coaxial tube for LFP with process connection G 3/4, process connection of coaxial tube G 3/4, material 1.4571/316TI, for probe length 1500 mm 	LFPCT-1500G1	2068152
	<ul style="list-style-type: none"> Description: Coaxial tube for LFP with process connection G 3/4, process connection of coaxial tube G 3/4, material 1.4571/316TI, for probe length 1800 mm 	LFPCT-1800G1	2068155
	<ul style="list-style-type: none"> Description: Coaxial tube for LFP with process connection G 3/4, process connection of coax probe G 3/4, material 1.4571/316TI, for probe length 1900 mm 	LFPCT-1900G1	2068156
	<ul style="list-style-type: none"> Description: Coaxial tube for LFP with process connection G 3/4, process connection of coaxial tube G 3/4, material 1.4571/316TI, for probe length 200 mm 	LFPCT-0200G1	2068141
	<ul style="list-style-type: none"> Description: Coaxial tube for LFP with process connection G 3/4, process connection of coaxial tube G 3/4, material 1.4571/316TI, for probe length 300 mm 	LFPCT-0300G1	2068142
	<ul style="list-style-type: none"> Description: Coaxial tube for LFP with process connection G 3/4, process connection of coaxial tube G 3/4, material 1.4571/316TI, for probe length 400 mm 	LFPCT-0400G1	2068143

	Brief description	Type	part no.
connectors and cables			
	<ul style="list-style-type: none"> Description: Sensor/actuator cable, unshielded Connection type head A: Female connector, M12, 5-pin, angled, A-coded Connection type head B: Flying leads Signal type: Sensor/actuator cable Cable: 2 m, 5-wire, PVC Application: Uncontaminated zones, Zones with chemicals 	YG2A15-020VB5XLEAX	2096215
	<ul style="list-style-type: none"> Description: Sensor/actuator cable, unshielded Connection type head A: Female connector, M12, 5-pin, angled, A-coded Connection type head B: Flying leads Signal type: Sensor/actuator cable Cable: 5 m, 5-wire, PVC Application: Uncontaminated zones, Zones with chemicals 	YG2A15-050VB5XLEAX	2096216
	<ul style="list-style-type: none"> Description: Sensor/actuator cable, unshielded Connection type head A: Female connector, M12, 5-pin, angled, A-coded Connection type head B: Flying leads Signal type: Sensor/actuator cable Cable: 10 m, 5-wire, PVC Application: Uncontaminated zones, Zones with chemicals 	YG2A15-100VB5XLEAX	2096217
	<ul style="list-style-type: none"> Description: Sensor/actuator cable, unshielded Connection type head A: Female connector, M12, 5-pin, straight, A-coded Connection type head B: Flying leads Signal type: Sensor/actuator cable Cable: 2 m, 5-wire, PUR, halogen-free Application: Drag chain operation, Zones with oils and lubricants, Robot, Drag chain operation 	YF2A15-020UB5XLEAX	2095617
	<ul style="list-style-type: none"> Description: Sensor/actuator cable, unshielded Connection type head A: Female connector, M12, 5-pin, straight, A-coded Connection type head B: Flying leads Signal type: Sensor/actuator cable Cable: 5 m, 5-wire, PUR, halogen-free Application: Drag chain operation, Zones with oils and lubricants, Robot, Drag chain operation 	YF2A15-050UB5XLEAX	2095618
	<ul style="list-style-type: none"> Description: Sensor/actuator cable, unshielded Connection type head A: Female connector, M12, 5-pin, straight, A-coded Connection type head B: Flying leads Signal type: Sensor/actuator cable Cable: 10 m, 5-wire, PUR, halogen-free Application: Drag chain operation, Zones with oils and lubricants, Robot, Drag chain operation 	YF2A15-100UB5XLEAX	2095619
	<ul style="list-style-type: none"> Description: Sensor/actuator cable, unshielded Connection type head A: Female connector, M12, 5-pin, angled, A-coded Connection type head B: Flying leads Signal type: Sensor/actuator cable Cable: 2 m, 5-wire, PUR, halogen-free Application: Drag chain operation, Zones with oils and lubricants, Robot, Drag chain operation 	YG2A15-020UB5XLEAX	2095772
	<ul style="list-style-type: none"> Description: Sensor/actuator cable, unshielded Connection type head A: Female connector, M12, 5-pin, angled, A-coded Connection type head B: Flying leads Signal type: Sensor/actuator cable Cable: 5 m, 5-wire, PUR, halogen-free Application: Drag chain operation, Zones with oils and lubricants, Robot, Drag chain operation 	YG2A15-050UB5XLEAX	2095773
	<ul style="list-style-type: none"> Description: Sensor/actuator cable, unshielded Connection type head A: Female connector, M12, 5-pin, angled, A-coded Connection type head B: Flying leads Signal type: Sensor/actuator cable Cable: 10 m, 5-wire, PUR, halogen-free Application: Drag chain operation, Zones with oils and lubricants, Robot, Drag chain operation 	YG2A15-100UB5XLEAX	2095774
	<ul style="list-style-type: none"> Description: Sensor/actuator cable, unshielded Connection type head A: Female connector, M12, 5-pin, straight, A-coded Connection type head B: Flying leads Signal type: Sensor/actuator cable Cable: 2 m, 5-wire, PVC Application: Uncontaminated zones, Zones with chemicals 	YF2A15-020VB5XLEAX	2096239
	<ul style="list-style-type: none"> Description: Sensor/actuator cable, unshielded Connection type head A: Female connector, M12, 5-pin, straight, A-coded Connection type head B: Flying leads Signal type: Sensor/actuator cable Cable: 5 m, 5-wire, PVC 	YF2A15-050VB5XLEAX	2096240

	Brief description	Type	part no.
	<ul style="list-style-type: none"> Application: Uncontaminated zones, Zones with chemicals Description: Sensor/actuator cable, unshielded Connection type head A: Female connector, M12, 5-pin, straight, A-coded Connection type head B: Flying leads Signal type: Sensor/actuator cable Cable: 10 m, 5-wire, PVC Application: Uncontaminated zones, Zones with chemicals 	YF2A15-100VB5XLEAX	2096241
	<ul style="list-style-type: none"> Description: Sensor/actuator cable, unshielded Connection type head A: Female connector, M12, 5-pin, angled, A-coded Connection type head B: Flying leads Signal type: Sensor/actuator cable Cable: 0.6 m, 5-wire, PUR, halogen-free Application: Drag chain operation, Zones with oils and lubricants, Robot, Drag chain operation 	YG2A15-C60UB5XLEAX	2145540
	<ul style="list-style-type: none"> Description: Sensor/actuator cable, unshielded Connection type head A: Female connector, M12, 5-pin, angled, A-coded Connection type head B: Flying leads Signal type: Sensor/actuator cable Cable: 3 m, 5-wire, PUR, halogen-free Application: Drag chain operation, Zones with oils and lubricants, Robot, Drag chain operation 	YG2A15-030UB5XLEAX	2145543
	<ul style="list-style-type: none"> Description: Sensor/actuator cable, unshielded Connection type head A: Female connector, M12, 5-pin, angled, A-coded Connection type head B: Flying leads Signal type: Sensor/actuator cable Cable: 1 m, 5-wire, PUR, halogen-free Application: Drag chain operation, Zones with oils and lubricants, Robot, Drag chain operation 	YG2A15-010UB5XLEAX	2145541
	<ul style="list-style-type: none"> Description: Sensor/actuator cable, unshielded Connection type head A: Female connector, M12, 5-pin, angled, A-coded Connection type head B: Flying leads Signal type: Sensor/actuator cable Cable: 0.6 m, 5-wire, PVC Application: Uncontaminated zones, Zones with chemicals 	YG2A15-C60VB5XLEAX	2145573
	<ul style="list-style-type: none"> Description: Sensor/actuator cable, unshielded Connection type head A: Female connector, M12, 5-pin, angled, A-coded Connection type head B: Flying leads Signal type: Sensor/actuator cable Cable: 1 m, 5-wire, PVC Application: Uncontaminated zones, Zones with chemicals 	YG2A15-010VB5XLEAX	2145574
	<ul style="list-style-type: none"> Description: Sensor/actuator cable, unshielded Connection type head A: Female connector, M12, 5-pin, angled, A-coded Connection type head B: Flying leads Signal type: Sensor/actuator cable Cable: 3 m, 5-wire, PVC Application: Uncontaminated zones, Zones with chemicals 	YG2A15-030VB5XLEAX	2145575
	<ul style="list-style-type: none"> Description: Sensor/actuator cable, unshielded Connection type head A: Female connector, M12, 5-pin, straight, A-coded Connection type head B: Flying leads Signal type: Sensor/actuator cable Cable: 0.6 m, 5-wire, PVC Application: Uncontaminated zones, Zones with chemicals 	YF2A15-C60VB5XLEAX	2145570
	<ul style="list-style-type: none"> Description: Sensor/actuator cable, unshielded Connection type head A: Female connector, M12, 5-pin, straight, A-coded Connection type head B: Flying leads Signal type: Sensor/actuator cable Cable: 3 m, 5-wire, PVC Application: Uncontaminated zones, Zones with chemicals 	YF2A15-030VB5XLEAX	2145572

SICK AT A GLANCE

SICK is one of the leading manufacturers of intelligent sensors and sensor solutions for industrial applications. A unique range of products and services creates the perfect basis for controlling processes securely and efficiently, protecting individuals from accidents and preventing damage to the environment.

We have extensive experience in a wide range of industries and understand their processes and requirements. With intelligent sensors, we can deliver exactly what our customers need. In application centers in Europe, Asia and North America, system solutions are tested and optimized in accordance with customer specifications. All this makes us a reliable supplier and development partner.

Comprehensive services complete our offering: SICK LifeTime Services provide support throughout the machine life cycle and ensure safety and productivity.

For us, that is “Sensor Intelligence.”

WORLDWIDE PRESENCE:

Contacts and other locations –www.sick.com