



# ZTB18-4PZ4A2D02

Z18 Simple Sense

PHOTOELECTRIC SENSORS

**SICK**  
Sensor Intelligence.



Illustration may differ



### Ordering information

Type	part no.
ZTB18-4PZ4A2D02	1139619

**Included in delivery:** BEF-MU-M18\*1 (2)

Other models and accessories → [www.sick.com/Z18\\_Simple\\_Sense](http://www.sick.com/Z18_Simple_Sense)

### Detailed technical data

#### Features

<b>Functional principle</b>	Photoelectric proximity sensor
<b>Functional principle detail</b>	Background suppression
<b>Dimensions (W x H x D)</b>	13.6 mm x 44.2 mm x 33.3 mm
<b>Housing design (light emission)</b>	Hybrid
<b>Mounting system type</b>	M18, head/M18, base
<b>Housing color</b>	Blue
<b>Sensing range max.</b>	5 mm ... 50 mm <sup>1)</sup>
<b>Sensing range</b>	5 mm ... 50 mm <sup>2)</sup>
<b>Type of light</b>	Visible red light
<b>Light source</b>	PinPoint LED
<b>Light spot size (distance)</b>	Ø 8 mm (100 mm)
<b>Wave length</b>	625 nm

<sup>1)</sup> Object with 90% remission (based on standard white, DIN 5033).

<sup>2)</sup> Object with 6% remission factor (based on standard black, DIN 5033).

#### Mechanics/electronics

<b>Supply voltage U<sub>B</sub></b>	10 V DC ... 30 V DC
<b>Ripple</b>	< 10 %
<b>Current consumption</b>	≤ 15 mA <sup>1)</sup>

<sup>1)</sup> Without load.

<sup>2)</sup> Signal transit time with resistive load.

<sup>3)</sup> With light/dark ratio 1:1.

<sup>4)</sup> A = V<sub>S</sub> connections reverse-polarity protected.

<sup>5)</sup> B = inputs and output reverse-polarity protected.

<sup>6)</sup> D = outputs overcurrent and short-circuit protected.

<b>Switching output</b>	PNP
<b>Switching mode</b>	Light switching
<b>Switching output detail</b>	
Switching output Q1	PNP, Light switching
Switching output Q2	Not connected
<b>Output current <math>I_{\max}</math></b>	100 mA
<b>Response time</b>	$\leq 1 \text{ ms}^2)$
<b>Switching frequency</b>	500 kHz <sup>3)</sup>
<b>Connection type</b>	Male connector M12, 4-pin
<b>Circuit protection</b>	A <sup>4)</sup> B <sup>5)</sup> D <sup>6)</sup>
<b>Protection class</b>	III
<b>Weight</b>	4.54 g
<b>Housing material</b>	Plastic, ABS
<b>Optics material</b>	Plastic, PMMA
<b>Enclosure rating</b>	IP67
<b>Ambient operating temperature</b>	-40 °C ... +55 °C
<b>Ambient temperature, storage</b>	-40 °C ... +70 °C
<b>UL File No.</b>	E189383

1) Without load.

2) Signal transit time with resistive load.

3) With light/dark ratio 1:1.

4) A =  $V_S$  connections reverse-polarity protected.

5) B = inputs and output reverse-polarity protected.

6) D = outputs overcurrent and short-circuit protected.

## Connection type/pinouts

<b>Connection type</b>	Male connector M12, 4-pin
<b>Pinouts</b>	
BN 1	+ (L+)
WH 2	Not connected
BU 3	- (M)
BK 4	Q <sub>1</sub>

## Certificates

<b>EU declaration of conformity</b>	✓
<b>UK declaration of conformity</b>	✓
<b>ACMA declaration of conformity</b>	✓
<b>Moroccan declaration of conformity</b>	✓
<b>China RoHS</b>	✓

## Classifications

<b>ECLASS 5.0</b>	27270904
-------------------	----------

<b>ECLASS 5.1.4</b>	27270904
<b>ECLASS 6.0</b>	27270904
<b>ECLASS 6.2</b>	27270904
<b>ECLASS 7.0</b>	27270904
<b>ECLASS 8.0</b>	27270904
<b>ECLASS 8.1</b>	27270904
<b>ECLASS 9.0</b>	27270904
<b>ECLASS 10.0</b>	27270904
<b>ECLASS 11.0</b>	27270904
<b>ECLASS 12.0</b>	27270903
<b>ETIM 5.0</b>	EC002719
<b>ETIM 6.0</b>	EC002719
<b>ETIM 7.0</b>	EC002719
<b>ETIM 8.0</b>	EC002719
<b>UNSPSC 16.0901</b>	39121528

### Dimensional drawing

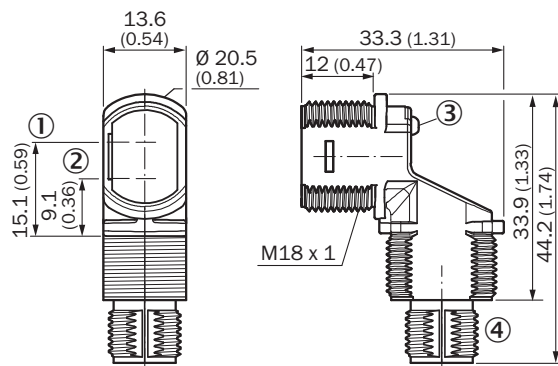

Dimensions in mm (inch)

- ① optical axis, sender
- ② optical axis, receiver
- ③ LED status indicator
- ④ Connection

### Pinouts, see table Technical data: Connection type/pinouts

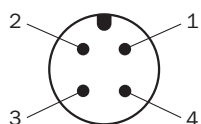

M12 male connector, 4-pin, A-coding

### Light spot size

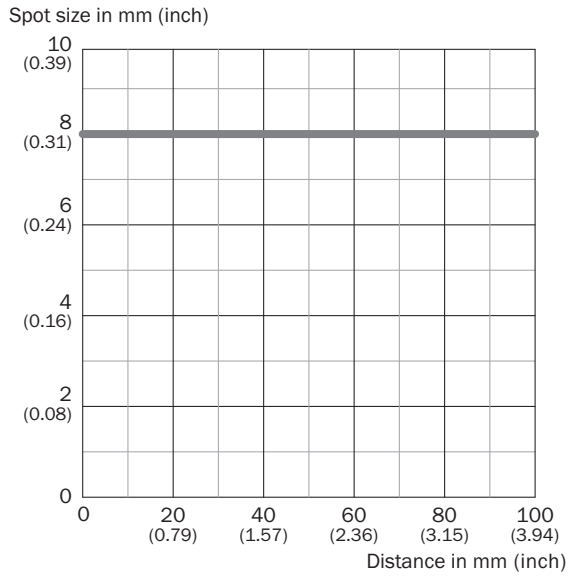



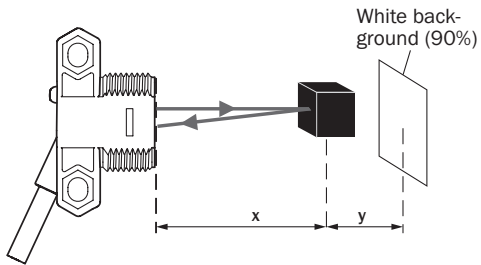

### Sensing range on black, 6% remission factor



ZTB18-xxxxxD02: x = 47 mm / y = 4 mm  
 ZTB18-xxxxxD04: x = 93 mm / y = 8 mm  
 ZTB18-xxxxxD06: x = 139 mm / y = 12 mm

### Recommended accessories

Other models and accessories → [www.sick.com/Z18\\_Simple\\_Sense](http://www.sick.com/Z18_Simple_Sense)

	Brief description	Type	part no.
<b>Mounting systems</b>			
	<ul style="list-style-type: none"> <li><b>Description:</b> Mounting bracket for M18 sensors</li> <li><b>Material:</b> Steel</li> <li><b>Details:</b> Steel, zinc coated</li> <li><b>Items supplied:</b> Without mounting hardware</li> <li><b>Suitable for:</b> GR18, V180-2, V18, W15, Z1, Z2</li> </ul>	BEF-WN-M18	5308446
	<ul style="list-style-type: none"> <li><b>Description:</b> Plate N11N for universal clamp bracket</li> <li><b>Material:</b> Stainless steel</li> <li><b>Details:</b> Stainless steel 1.4571 (sheet), Stainless steel 1.4408 (clamp)</li> <li><b>Items supplied:</b> Universal clamp (5322627), mounting hardware</li> <li><b>Usable for:</b> DeltaPac, Glare, WTD20E</li> </ul>	BEF-KHS-N11N	2071081
<b>connectors and cables</b>			
	<ul style="list-style-type: none"> <li><b>Connection type head A:</b> Female connector, M12, 4-pin, straight, A-coded</li> <li><b>Connection type head B:</b> Flying leads</li> <li><b>Signal type:</b> Sensor/actuator cable</li> <li><b>Cable:</b> 5 m, 4-wire, PVC</li> <li><b>Description:</b> Sensor/actuator cable, unshielded</li> <li><b>Application:</b> Uncontaminated zones, Zones with chemicals</li> </ul>	YF2A14-050VB3XLEAX	2096235
	<ul style="list-style-type: none"> <li><b>Description:</b> Unshielded</li> <li><b>Connection type head A:</b> Male connector, M12, 4-pin, straight, A-coded</li> <li><b>Connection systems:</b> Screw-type terminals</li> <li><b>Permitted cross-section:</b> ≤ 0.75 mm<sup>2</sup></li> </ul>	STE-1204-G	6009932
	<ul style="list-style-type: none"> <li><b>Connection type head A:</b> Female connector, M12, 4-pin, straight, A-coded</li> <li><b>Connection type head B:</b> Flying leads</li> <li><b>Signal type:</b> Sensor/actuator cable</li> <li><b>Cable:</b> 5 m, 4-wire, PUR, halogen-free</li> <li><b>Description:</b> Sensor/actuator cable, unshielded</li> <li><b>Application:</b> Drag chain operation, Zones with oils and lubricants, Robot, Drag chain operation</li> </ul>	YF2A14-050UB3XLEAX	2095608

## SICK AT A GLANCE

SICK is one of the leading manufacturers of intelligent sensors and sensor solutions for industrial applications. A unique range of products and services creates the perfect basis for controlling processes securely and efficiently, protecting individuals from accidents and preventing damage to the environment.

We have extensive experience in a wide range of industries and understand their processes and requirements. With intelligent sensors, we can deliver exactly what our customers need. In application centers in Europe, Asia and North America, system solutions are tested and optimized in accordance with customer specifications. All this makes us a reliable supplier and development partner.

Comprehensive services complete our offering: SICK LifeTime Services provide support throughout the machine life cycle and ensure safety and productivity.

For us, that is “Sensor Intelligence.”

## WORLDWIDE PRESENCE:

Contacts and other locations –[www.sick.com](http://www.sick.com)